



2022

OUR PASSION FROM WITHIN



2022

OUR PASSION FROM WITHIN



After a pandemic 2021 still, first of all we want to apologize for the delays in the deliveries of a good number of references in our catalog, as a result of the shortages of raw materials and difficulties in the international shipping which are well known. We hope that by the beginning of 2022, the situation will normalize and we can gradually recover the quality of our service. To highlight in this catalog, is the incorporation of a Custom-Cruiser product line of semi-fairings and engine protectors of our own design and manufacture.

We are faithful to the technical collaboration in MOTO GP and SUPERBIKES with HRC (MOTO GP) and KRT (SUPERBIKES) teams, testing new materials, shapes and designs that are already being applied in the products of this new catalog. From here, we support both teams with all our technology, so that they give us a new world crown to add to our list of honors in 2021-2022, just as Jonathan Rea did for 2020 SUPERBIKES.

In this new catalog we have been forced, due to volume, reliability and updating issues to restrict the number of application charts and support their consultation through our website.

We highlight the following 2022 news that you can find in the catalog:

- Extension of the range of **GP and Naked frontal spoilers** (pages 43 and 49).
- **Upper front area:** Mito universal windshield (page 140), Off-road semi-fairing (page 105), Vespa GTS windshield (page 196) and the new 2.0 multi-adjustable visors (page 117).
- **Handlebar area:** Sport and Speed barend weights (page 271 and 273) and Fold and Z2 rearview mirrors (page 281).
- **Middle front zone:** Fun sequential indicator (page 413) and Hi-Beam 2.0 fog lamps (page 401).
- **Chassis-engine area:** Frame Sliders Pro 2.0 (page 517), Off-road Footpegs (page 493), Enduro Footpegs 2.0 and Trail 2.0 (page 465).
- **Rear area:** Angle license plate lighting group (page 448), Supports for specific delivery trunks for different models of scooters (page 631).
- **Deposit area:** We have started a collaboration with MARC MÁRQUEZ selecting us as their official manufacturer of tankpads with his logos (page 349).

For one more year, we appreciate the trust you place in the brand, which encourages us to continue pushing to keep this catalog up to date, year after year and wishing to put an end to COVID19.

Stay safe,



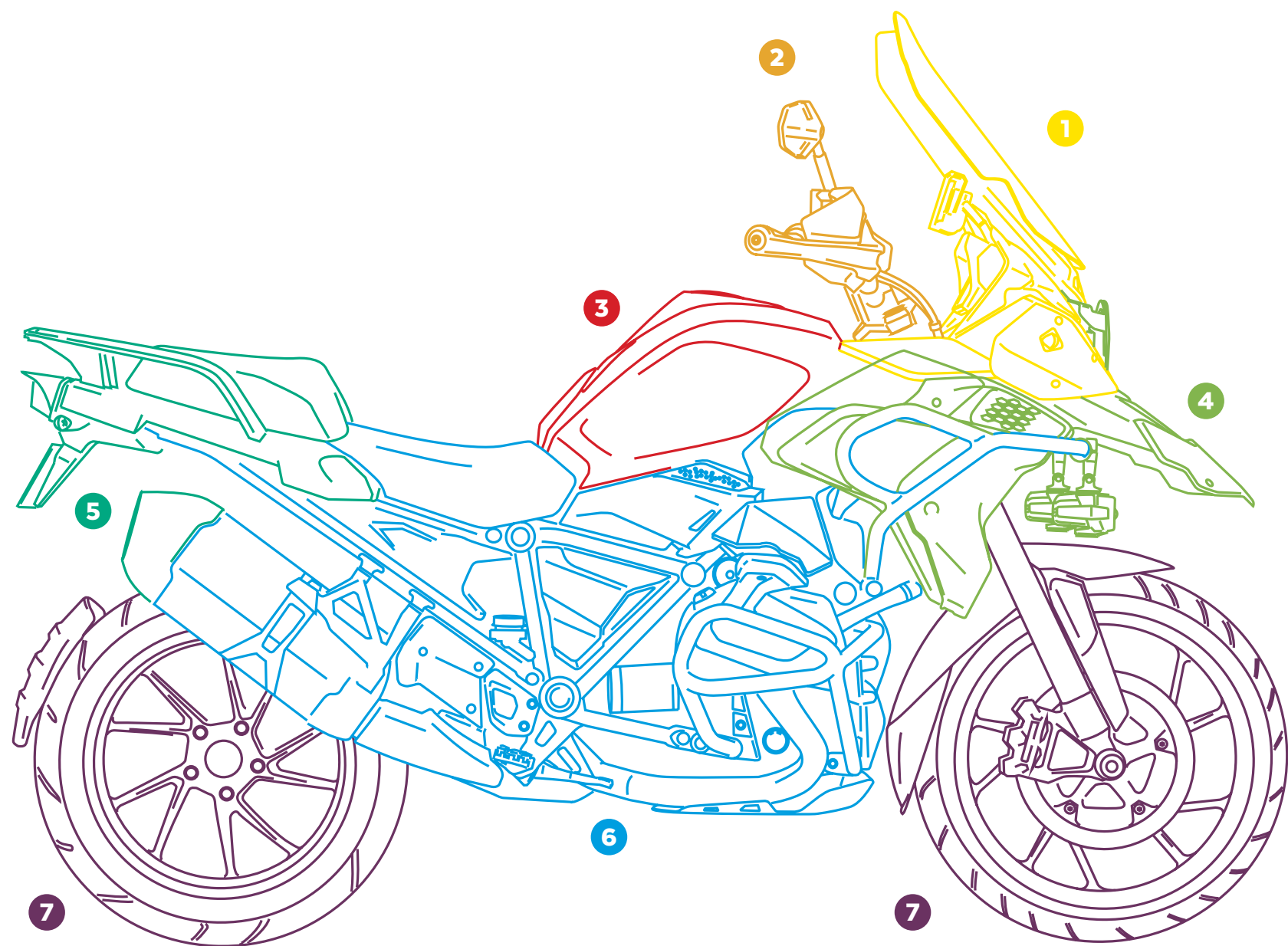

■ FULLY EQUIPPED MOTORCYCLES	P. 8
■ RACING	P. 32
■ 1. SUPERIOR FRONT AREA	P. 53
■ 2. HANDLEBAR AREA	P. 205
■ 3. GAS TANK AREA	P. 343
■ 4. MIDDLE FRONT AREA	P. 389
■ 5. REAR AREA	P. 439
■ 6. CHASSIS-ENGINE AREA	P. 459
■ 7. WHEELS AREA	P. 555
■ MAINTENANCE / WORKSHOP	P. 605
■ WINTER	P. 612
■ DELIVERY	P. 615
■ MERCHANDISING	P. 625

FULLY EQUIPPED

YAMAHA MT-07 21"	10
YAMAHA MT-09 21"	12
BMW R1250GS	14
YAMAHA T-MAX 560	16
KAWASAKI Z650	18
KAWASAKI Z900	20
APRILIA RS660	22
BMW F850GS	24
HONDA CB500X	26
KAWASAKI ZH2	28
KTM 1290 SUPERDUKE GT	30

YAMAHA MT-07 21'

1. WINDSHIELD NG SPORT	134
2. REAR FENDER EXTENSION	565
3. AUXILIARY LIGHTS	403
4. ENGINE SPOILERS	511
5. FRAME SLIDERS R19 MODEL	521
6. AXLE SLIDERS PHB19	583
7. AXLE SLIDERS PHB19	583
8. LICENSE SUPPORTS	441
9. BRAKE / CLUTCH LEVER PROTECTOR	229
10. R-FIGHTER S FOOTPEGS	461
11. RACING FOOTPEGS	463
12. REARVIEW MIRROR GTI	303
13. SPECIAL RIM STRIPS	591



YAMAHA MT-09 21'

1. WINDSHIELD NG SPORT	134
2. ENGINE SPOILERS	511
3. FRAME SLIDERS R19 MODEL	521
4. AXLE SLIDERS PHB19	583
5. AXLE SLIDERS PHB19	583
6. LICENSE SUPPORTS	441
7. BRAKE / CLUTCH LEVER PROTECTOR	229
8. RACING FOOTPEGS	463
9. RACING GRIPS	267
10. REARVIEW MIRROR GTI	303
11. SPOOL PRO	503
12. PLUG-OIL CAPS	501



BMW R1250GS

1. WINDSCREEN TOURING	57
2. E.R.S. (Electronic Regulation System)	109
3. HANDGUARD EXTENSIONS	319
4. SIDE PANELS	547
5. INTAKE COVER	550
6. UPPER DEFLECTORS	139
7. LOWER DEFLECTORS	395
8. HEADLIGHT PROTECTOR	397
9. ENGINE GUARDS	537
10. ENDURO FOOTPEGS	467
11. SPORT FOOTPEGS	463
12. PLUG-OIL CAPS	501



YAMAHA T-MAX 560

1. WINDSCREEN V-TECH LINE SUPERSPORT	114
2. AXLE SLIDERS PHB19	583
3. AXLE SLIDERS PHB19	583
4. LICENSE SUPPORTS	441
5. LEVERS 3.0	211
6. SPORT FOOTPEGS	463
7. BAR ENDS THRUSTER MODEL	277
8. REARVIEW MIRROR F1.1	305
9. PARKING BRAKE LEVER	259
10. CLUTCH COVER	545
11. TENSORS FOR REAR WHEEL BY PAIR	585



KAWASAKI Z650

1. WINDSHIELD NG SPORT	131
2. ENGINE SPOILERSS	511
3. DOWNFORCE SPOILERS NAKED	47
4. FRAME SLIDERS R19 MODEL	521
5. AXLE SLIDERS PHB19	583
6. LICENSE SUPPORTS	441
7. LEVERS 3.0.	211
8. R-FIGHTER FOOTPEGS	461
9. ASCENT GRIPS	263
10. BAR ENDS THRUSTER MODEL	277
11. REARVIEW MIRROR F1.1	305
12. MOBILE CASE	333
13. BRAKE-CLUTCH LIQUID TANK COVER	250
14. SPOOL PRO	503
15. PLUG-OIL CAPS HI-TECH	501



KAWASAKI Z900

1. WINDSHIELD NG SPORT	131
2. ENGINE SPOILERSS	511
3. DOWNFORCE SPOILERS NAKED	47
4. AXLE SLIDERS PHB19	583
5. LICENSE SUPPORTS	441
6. LEVERS 3.0.	211
7. RACING FOOTPEGS	463
8. ASCENT GRIPS	263
9. BAR ENDS SHORT MODELS	275
10. REARVIEW MIRROR HYPERNAKED	297
11. BRAKE-CLUTCH LIQUID TANK COVER	250
12. SPOOL PRO	503
13. PLUG-OIL CAPS HI-TECH	501



APRILIA RS 660

1. WINDSCREEN R-RACER	56
2. FRAME SLIDERS R19 MODEL	521
3. LICENSE SUPPORTS	441
4. RACING FOOTPEGS	463
5. MOBILE SUPPORT	335



BMW F850GS

1. WINDSCREEN TOURING	57
2. E.R.S. (Electronic Regulation System)	109
3. HANDGUARD EXTENSIONS	319
4. SINGLE-SIDED REAR FENDER	569
5. SIDE PANELS	547
6. HEADLIGHT PROTECTOR	397
7. AXLE SLIDERS PHB19	583
8. AXLE SLIDERS PHB19	583
9. ENGINE GUARDS	537
10. ENDURO FOOTPEGS	465
11. SPORT FOOTPEGS	463
12. REARVIEW MIRROR EXPLORER	299



HONDA CB500X

1. WINDSCREEN TOURING	56
2. REAR FENDER EXTENSION	565
3. HI-BEAM 2.0 AUXILIARY LIGHTS	401
4. ENGINE GUARDS	537
5. BRAKE / CLUTCH LEVER PROTECTOR	229
6. TRAIL FOOTPEGS	465
7. SPORT FOOTPEGS	463
8. REARVIEW MIRROR EXPLORER	299
9. PLUG-OIL CAPS	501



KAWASAKI ZH2

1. WINDSHIELD NG SPORT	132
2. FRAME SLIDERS R19 MODEL	521
3. AXLE SLIDERS PHB19	583
4. LICENSE SUPPORTS	441
5. LEVERS 3.0.	211
6. SPORT FOOTPEGS	463
7. RACING GRIPS	267
8. BAR ENDS SHORT WITH RING	279
9. REARVIEW MIRROR HYPERNAKED	297
10. SPOOL PRO	503
11. PLUG-OIL CAPS	501



KTM 1290 SUPERDUKE GT

1. WINDSCREEN TOURING	57
2. ENGINE SPOILERS	511
3. FRAME SLIDERS R19 MODEL	521
4. AXLE SLIDERS PHB19	583
5. LICENSE SUPPORTS	441
6. ENDURO FOOTPEGS	465
7. REARVIEW MIRROR EXPLORER	299





#93

MARC MÁRQUEZ
HONDA REPSOL TEAM MOTOGP 2021



Puig
Hi-Tech Parts

#44

POL ESPARGARÓ
HONDA REPSOL TEAM MOTOGP 2021



#1

JOANTHAN REA
KAWASAKI RACING TEAM WORLD
SBK 2021



#22

ALEX LOWES
KAWASAKI RACING TEAM WORLD SBK 2021

Puig
Hi-Tech Parts

#24

SIMONE CORSI
MV AGUSTA FORWARD RACING TEAM MOTO2 2021



#7

LORENZO BALDASSARRI
MV AGUSTA FORWARD RACING TEAM MOTO2 2021

Puig
Hi-Tech Parts

#11

MATHEW SCHOLTZ
WESTBY RACING TEAM MOTOAMERICA 2021



#12

JACK ROACH
WESTBY RACING TEAM MOTOAMERICA 2021

Puig
Hi-Tech Parts



DOWNFORCE SPOILERS SPORT

HI-TECH PARTS | TECHNICAL SECTION



ANTI-WHEELIE



ANTI SHIMMIE

More stability on straights.



DOWNFORCE

More composure when braking.



STABILITY

More stability when changing direction.



REF. 3162V

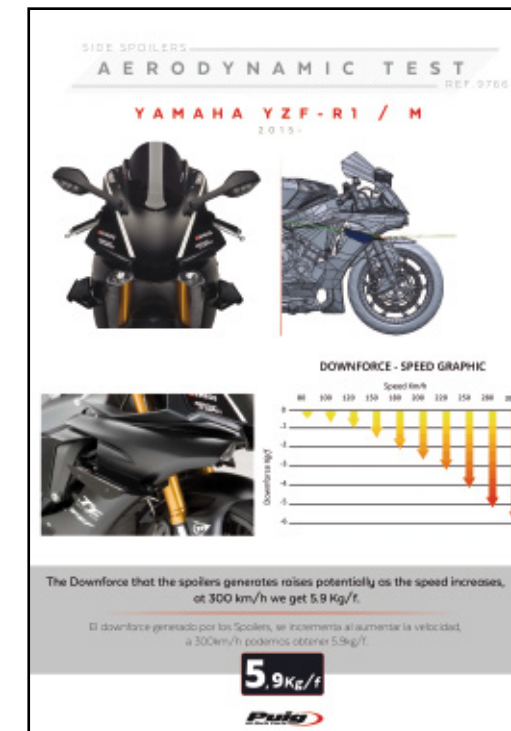

Aerodynamic test supplied along most of our spoilers.

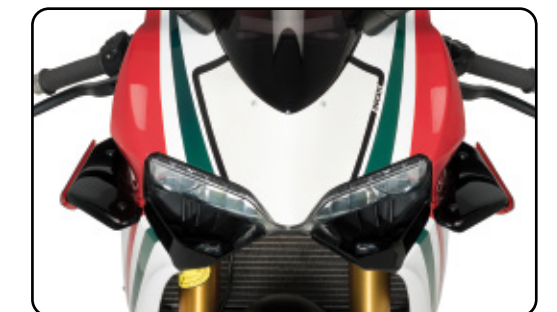

They consist of:

- Set of spoilers made of 4 mm. thick CN High-Impact acrylic. Always in black.
- Set of deflectors available in colors.

Puig's Downforce Sport spoilers have been developed thanks to the experience and tests carried out by the Kawasaki Racing team on the WorldSBK championship circuits. Get the ultimate racing touch and improve the cornering of your motorcycle with these Downforce Sport spoilers.

FOR SPECIFIC MODELS SEE PAGE 44.





DOWNFORCE SPOILERS RACE

HI-TECH PARTS | TECHNICAL SECTION



ANTI-WHEELIE



ANTI SHIMMIE

More stability on straights.



DOWNFORCE

More composure when braking.



STABILITY

More stability when changing direction.

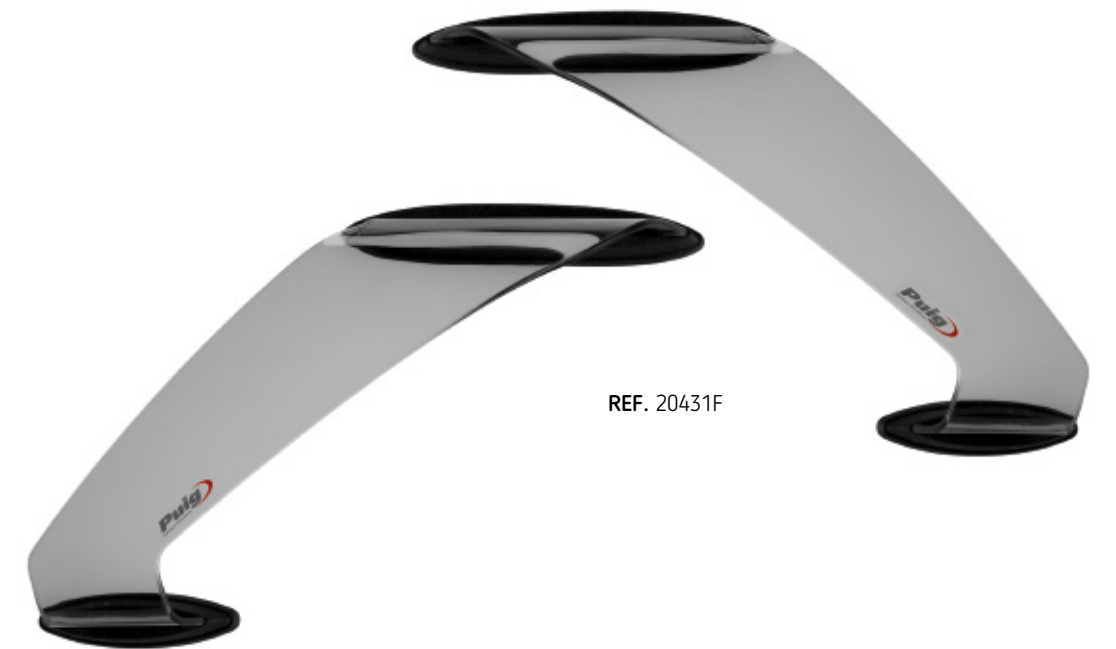

REF. 20431F

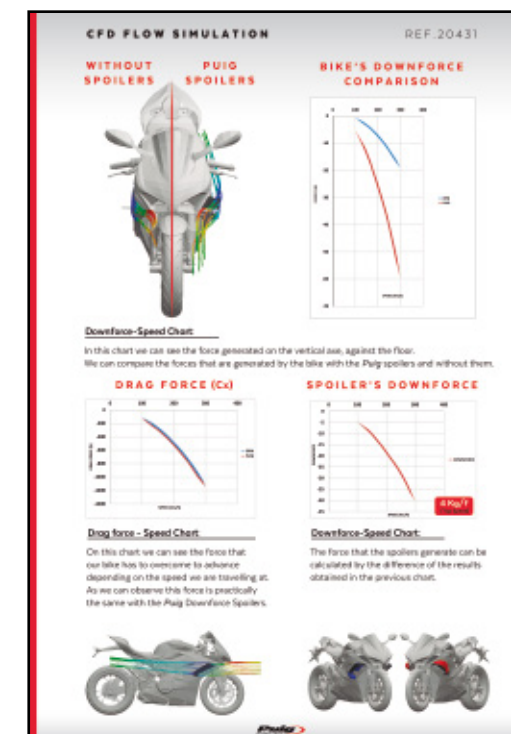

Aerodynamic test supplied along most of our spoilers.



They are made up of two elements:

- Supports injected in flexible black plastic that adapt perfectly to the fairing of your motorcycle by means of a 3M dual lock adhesive, strong, resistant and durable, but that can be removed and does not damage or require holes in your fairing.
- Spoiler in closed form, which is made of 4 mm. acrylic material. To choose a color, following safety regulations, with rounded edges with a radius >2 mm., a highly rigid and light material that is perfect for receiving aerodynamic pressure and directly translating it into downforce.

This product, extracted from the experience of the brand in the Moto GP championship, manages to provide greater air pressure in the front end in high-speed sections and improve cornering.

FOR SPECIFIC MODELS SEE PAGE 44.

N Black

R Red

V Green

H Smoke



FRONTAL SPOILER GP

HI-TECH PARTS | TECHNICAL SECTION

Puig
Racing Screens

NEW!



ANTI-WHEELIE



ANTI SHIMMIE

More stability on straights.



DOWNFORCE

More composure when braking.



STABILITY

More stability when changing direction.



REF. 20508N

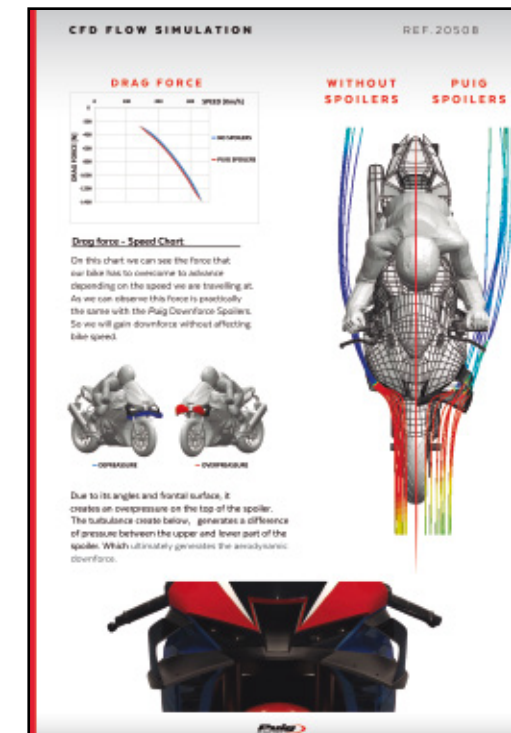

The new Frontal Spoiler GP is the mix of the most advanced knowledge and technologies in the field of competition motorcycling, and has been designed and manufactured entirely in Barcelona.

Made of 4mm ABS, a highly resistant material against impacts, with a matt black finish, it will provide your vehicle with a new aerodynamic plus, in addition to giving it a sport and elegant character according to the aesthetics of your motorcycle.

Mounting it to your motorcycle will be a simple and fast task, without the need for specific mechanical knowledge or tools and without requiring holes for mounting.

FOR SPECIFIC MODELS SEE PAGE 44.

N Black

R Red

H Smoke

A Blue

W Transparent

Aerodynamic test supplied along most of our spoilers.

DOWNFORCE SPOILERS

HI-TECH PARTS | TYPE OF DOWNFORCE SPOILERS:

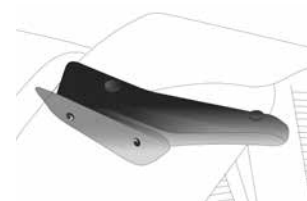

DOWNFORCE SPOILERS SPORT



DOWNFORCE SPOILERS RACE

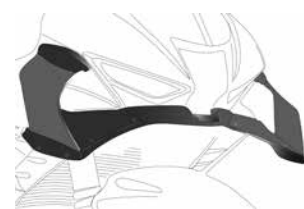

FRONTAL SPOILER GP

2022		For the new 2022 motorcycle models check www.puig.tv			
MODEL	YEAR	TYPE	REF.	N R H A W V	
APRILIA					
RSV4 RF/RR	15' - 20'	SPORT	2334	(*)	
BMW					
S1000RR	15' - 18'	SPORT	9767	(*)	
S1000RR	19' - 21'	SPORT	3636	(*)	
S1000RR	19' - 21'	FRONTAL	20522	(*)	
DUCATI					
899 PANIGALE	14' - 15'	SPORT	3566	(*)	
959 PANIGALE	16' - 20'	SPORT	3165	(*)	
959 PANIGALE CORSE	18' - 20'	SPORT	3165	(*)	
1199 PANIGALE/S	12' - 15'	SPORT	3566	(*)	
1199 PANIGALE R	15' - 17'	SPORT	3566	(*)	
1299 PANIGALE/S	15' - 17'	SPORT	3165	(*)	
PANIGALE V2	20' - 21'	RACE	20431	(*)	
PANIGALE V2 BAYLISS	21'	RACE	20431	(*)	
PANIGALE 1100 V4	18' - 19'	RACE	20431	(*)	
PANIGALE 1100 V4S	18' - 19'	RACE	20431	(*)	
HONDA					
CBR500R	19' - 21'	SPORT	3614	(*)	
CBR650R	19' - 21'	SPORT	3569	(*)	
CBR600RR	13' - 16'	SPORT	3161	(*)	
CBR1000RR FIREBLADE/SP/SP2	17' - 19'	SPORT	9729	(*)	
CBR1000RR FIREBLADE/SP	20' - 21'	FRONTAL	20508	(*)	
KAWASAKI					
NINJA 400	18' - 21'	SPORT	3172	(*)	
NINJA 650	17' - 19'	SPORT	3835	(*)	
NINJA 650	20' - 21'	SPORT	3882	(*)	
NINJA H2 SX	18' - 21'	SPORT	3658	(*)	
NINJA 1000 SX	20' - 21'	SPORT	20623	(*)	
ZX-6R	09' - 16'	SPORT	3162	(*)	
ZX-6R 636	13' - 16'	SPORT	3162	(*)	

2022		For the new 2022 motorcycle models check www.puig.tv			
MODEL	YEAR	TYPE	REF.	N R H A W V	
ZX-6R 636	19' - 21'	SPORT	3176	(*)	
ZX-10R	11' - 15'	SPORT	9882	(*)	
ZX-10R	16' - 20'	SPORT	9882	(*)	
ZX-10R	21'	RACE	20543	(*)	
ZX-10RR	17' - 20'	SPORT	9882	(*)	
ZX-10RR	21'	RACE	20543	(*)	
ZX-10R SE	18' - 20'	SPORT	9882	(*)	
ZZR1400	06' - 21'	SPORT	20569	(*)	
MV AGUSTA					
F3 675	11' - 21'	SPORT	3173	(*)	
F3 800	13' - 21'	SPORT	3173	(*)	
SUZUKI					
GSX-R600/750	11' - 16'	SPORT	3163	(*)	
GSX-R1000/R	17' - 21'	SPORT	9738	(*)	
YAMAHA					
YZF-R1	15' - 19'	SPORT	9766	(*)	
YZF-R1	20' - 21'	SPORT	20297	(*)	
YZF-R1	20' - 21'	FRONTAL	20523	(*)	
YFZ-R1 M	17' - 19'	SPORT	9766	(*)	
YFZ-R1 M	20' - 21'	SPORT	20297	(*)	
YFZ-R1 M	20' - 21'	FRONTAL	20523	(*)	
YZF-R3	15' - 18'	SPORT	3171	(*)	
YZF-R3	19' - 21'	SPORT	3739	(*)	
YZF-R6	17' - 20'	SPORT	1946	(*)	
YZF-R6 RACE	21'	SPORT	1946	(*)	

SPARES		REF.	A R V N	
DEFLECTORS SET FOR DOWNLORCE SPOILERS		3692	(*)	

■ R Red ■ V Green ■ N Black
■ H Smoke ■ A Blue W Transparent

(*) Check price with your distributor.
 IMPORTANT: Indicate code color after part#. Example 0973A.



DOWNFORCE SPOILERS NAKED

HI-TECH PARTS | TECHNICAL SECTION



ANTI-WHEELIE



ANTI SHIMMIE

More stability on straights.



DOWNFORCE

More composure when braking.



STABILITY

More stability when changing direction.



REF. 20380R

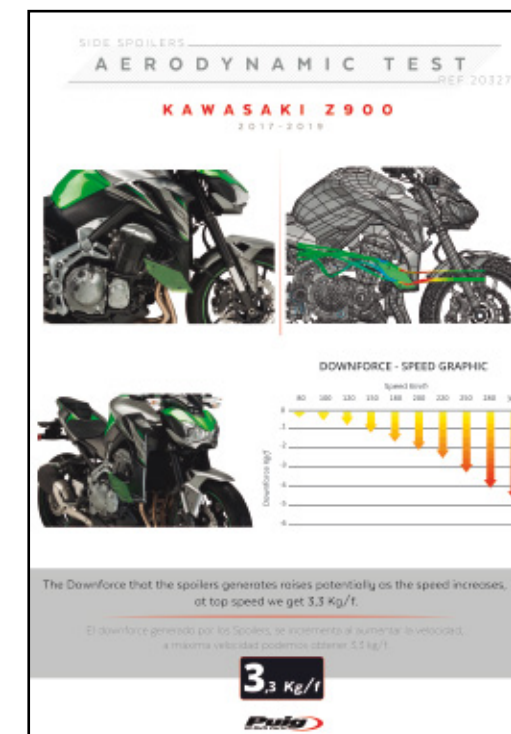

Aerodynamic test supplied along most of our spoilers.

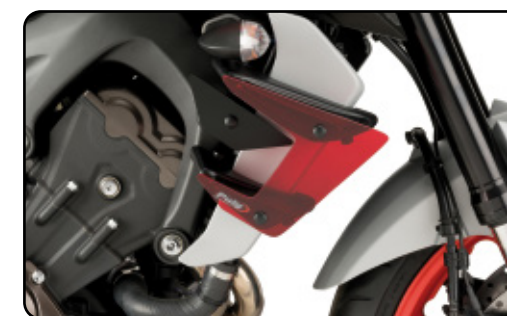

Naked spoilers are made up of:

- Spoiler-covers in matt black ABS material, which are easily installed on your motorcycle by means of metal supports with an anti-corrosion finish in black, light and resistant.
- Deflectors, which are made of 4 mm. thick CN acrylic material and a color to choose from (colors defined according to models). These deflectors have a rounded Ø 4 mm. edge for greater rider safety.

The NAKED spoilers are an adaptation of the most cutting-edge innovations in competition in the field of aerodynamics applied to your motorcycle, providing it with the best performance and an incomparable sport style. Designed and manufactured in Barcelona with the most advanced technologies to achieve a technical product with the best aesthetics and finishes.

FOR SPECIFIC MODELS SEE PAGE 50.

- R Red
- V Green
- J Matt black
- F Dark Smoke
- T Orange
- A Blue
- N Black



FRONTAL SPOILER NAKED

HI-TECH PARTS | TECHNICAL SECTION

Puig
Racing Screens

NEW!



ANTI-WHEELIE



ANTI SHIMMIE

More stability on straights.



DOWNFORCE

More composure when braking.



STABILITY

More stability when changing direction.

REF. 20626J

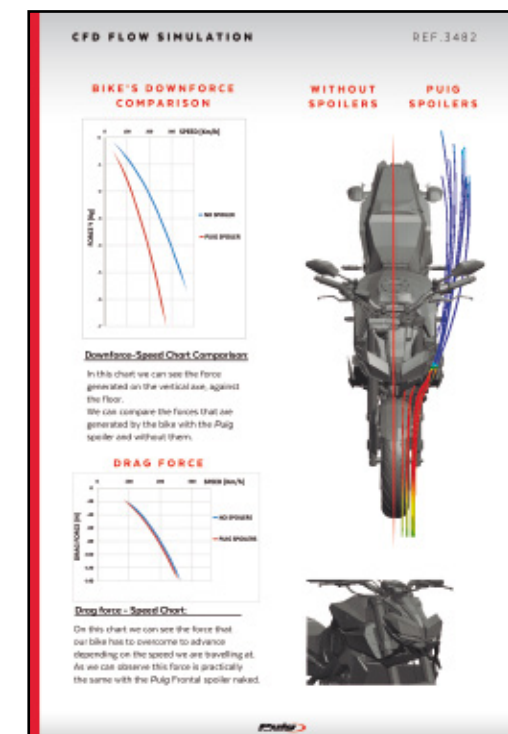

Boost the aesthetics and sport character, as well as improving the aerodynamic aspect, of your motorcycle with the Naked front spoiler from Puig.

Designed in Barcelona with the most innovative technologies, the new Naked front spoiler is made of 3mm matt black ABS, highly resistant material to any type of impact, which gives your motorcycle that aggressive look as well as elegant that you are looking for.

The assembly will be a simple and fast task, without the need for specific mechanical knowledge or it is necessary to affect any critical area of the motorcycle, since it is fixed to the vehicle through a 3mm metal support.

FOR SPECIFIC MODELS SEE PAGE 50.

 J Matt black

Aerodynamic test supplied along most of our spoilers.

NAKED SPOILERS

HI-TECH PARTS | TYPE OF DOWNFORCE SPOILERS:

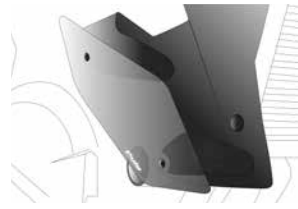

DOWNFORCE SPOILERS NAKED



FRONTAL SPOILER NAKED

2022		For the new 2022 motorcycle models check www.puig.tv			
MODEL	YEAR	TYPE	REF.	ARTVFNJ	
KAWASAKI					
Z650	20' - 21'	NAKED	20328		(*)
Z900	17' - 19'	NAKED	20327		(*)
Z900	20' - 21'	NAKED	20284		(*)
Z900	20' - 21'	FRONTAL	20626		(*)
Z H2	20' - 21'	NAKED	20832		(*)
KTM					
1290 SUPERDUKE R	20' - 21'	NAKED	20462		(*)
YAMAHA					
MT-07	18' - 20'	NAKED	20381		(*)
MT-07	21'	NAKED	20621		(*)
MT-09	17' - 20'	NAKED	20380		(*)
MT-09 SP	18' - 20'	NAKED	20380		(*)
MT-09	17' - 20'	FRONTAL	3482		(*)
MT-09 SP	18' - 20'	FRONTAL	3482		(*)
MT-09	21'	NAKED	20647		(*)
MT-09 SP	21'	NAKED	20647		(*)

- R Red
- V Green
- J Matt black
- F Dark Smoke
- T Orange
- A Blue
- N Black

(*) Check price with your distributor.
 IMPORTANT: Indicate code color after part#. Example 0973A.



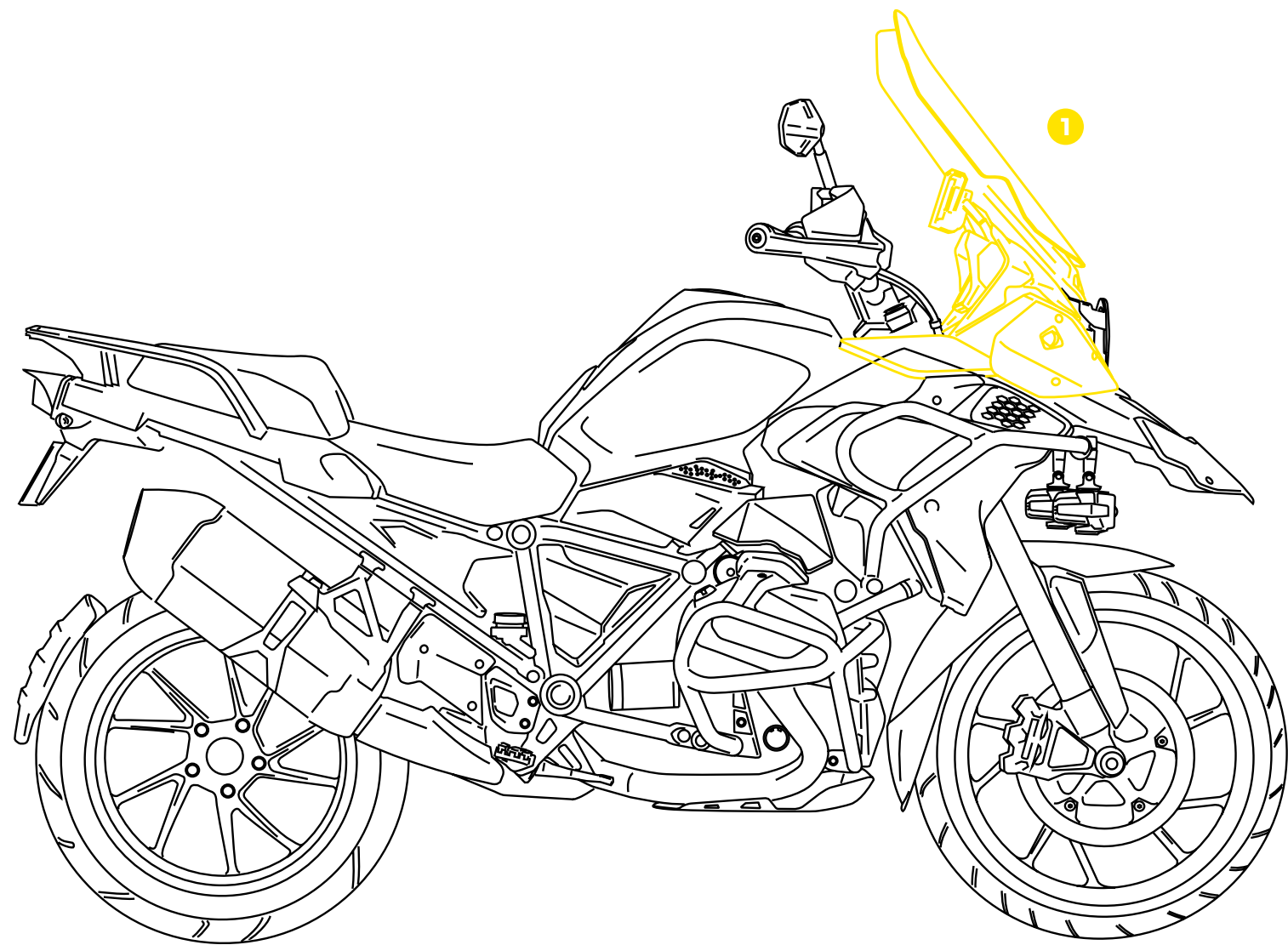

SUPERIOR FRONT AREA

BATWING SML	191	WINDSHIELD CUSTOM II	174
CLOCK TOPS	136	WINDSHIELD CUSTOM II WITH VISOR	175
DEFLECTORS FOR WINDSHIELDS	125	WINDSHIELD DAYTONA III	182
E.R.S. (Electronic Regulation System)	109	WINDSHIELD DAYTONA IV	181
FRONTAL DEFLECTORS SCREENS	137	WINDSHIELD FLANKER	141
FRONTAL PLATE (IN ABS)	155	WINDSHIELD GTS SPORT	196
FRONTAL PLATE (IN ALUMINIUM)	153	WINDSHIELD GTS TOURING	197
HAND GUARDS	203	WINDSHIELD HIGHWAY	180
M.E.M. (Manual Elevation System)	107	WINDSHIELD MITO	140
MULTIADJUSTABLE VISORS 2.0. CLIP-ON	119	WINDSHIELD NAKED	164
MULTIADJUSTABLE VISORS 2.0. FIXED BY SCREWS	117	WINDSHIELD PLUS	172
MULTIADJUSTABLE VISORS CLIP-ON	123	WINDSHIELD RAFALE	143
MULTIADJUSTABLE VISORS FIXED BY SCREWS	121	WINDSHIELD RANGER	176
NUMBERS	163	WINDSHIELD RAPTOR	165
RETROVISIONS	151	WINDSHIELD ROADSTER	178
SCREWS	102	WINDSHIELD SPECIFIC FOR NON-ROUND HEADLIGHTS	127
SEMI-FAIRINGS	149	WINDSHIELD T.S.	201
SEMIFAIRING ANARCHY	187	WINDSHIELD T.X.	202
SEMIFAIRING DARK NIGHT	189	WINDSHIELD TOP	171
SEMIFAIRING RALLY	105	WINDSHIELD TOURING I	177
UPPER DEFLECTORS	139	WINDSHIELD TOURING II	147
WINDSCREEN MODELS	56	WINDSHIELD TRACK	168
WINDSCREENS FOR FAIRING BIKES	55	WINDSHIELD TRAFIC	199
WINDSHIELD AMERICA I	183	WINDSHIELD TREND	145
WINDSHIELD AMERICA II	184	WINDSHIELD TREND WITH VISOR	146
WINDSHIELD AMERICA III	185	WINDSHIELD UP&DOWN	144
WINDSHIELD BAT	142	WINDSHIELD URBAN	200
WINDSHIELD CHOPPER	179	WINDSHIELD VISION	170
WINDSHIELD CITY TOURING	198	WINDSHIELD WAVE	167
WINDSHIELD COCKPIT	166	WINDSHIELD WINDY	169
WINDSHIELD CUSTOM I	173	WINDSHIELDS FOR MAXISCOOTERS	111



WINDSCREENS FOR FAIRING BIKES

HI-TECH PARTS | TECHNICAL SECTION



SCREEN TESTED IN THE VIRTUAL WIND TUNNEL

Improved aerodynamics and wind protection on average 12,7% compared with OEM screen.

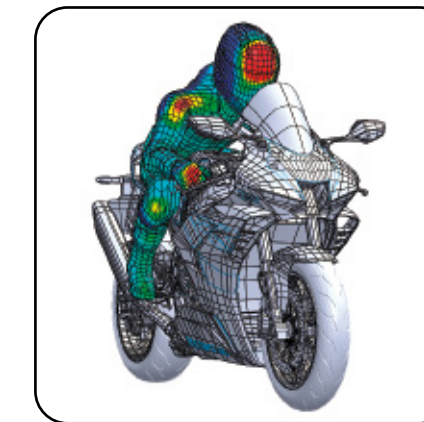

● Lower pressure
● Max. pressure
Wind pressure with a Puig screen.

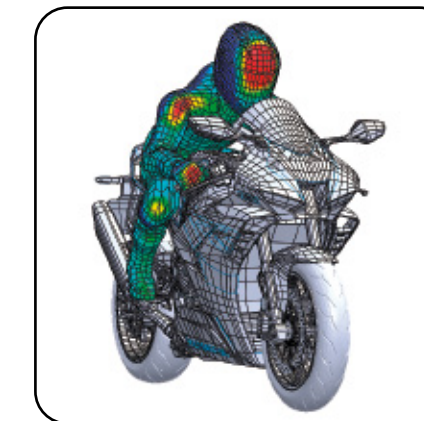

● Lower pressure
● Max. pressure
Wind pressure with a OEM screen.

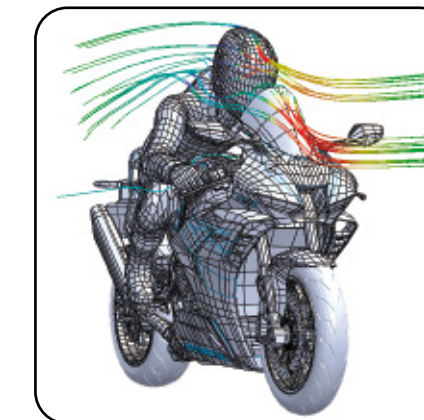

Improved aerodynamics and wind protection on average +12,7%



3 mm. high impact acrylic.
Resistant - Durable.
Precise fit.

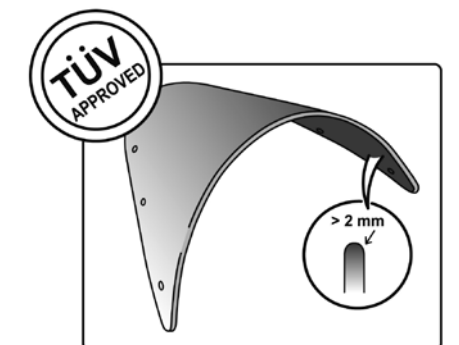

Rounded edge screen profile in >2 mm. Complying with the German TÜV regulations.

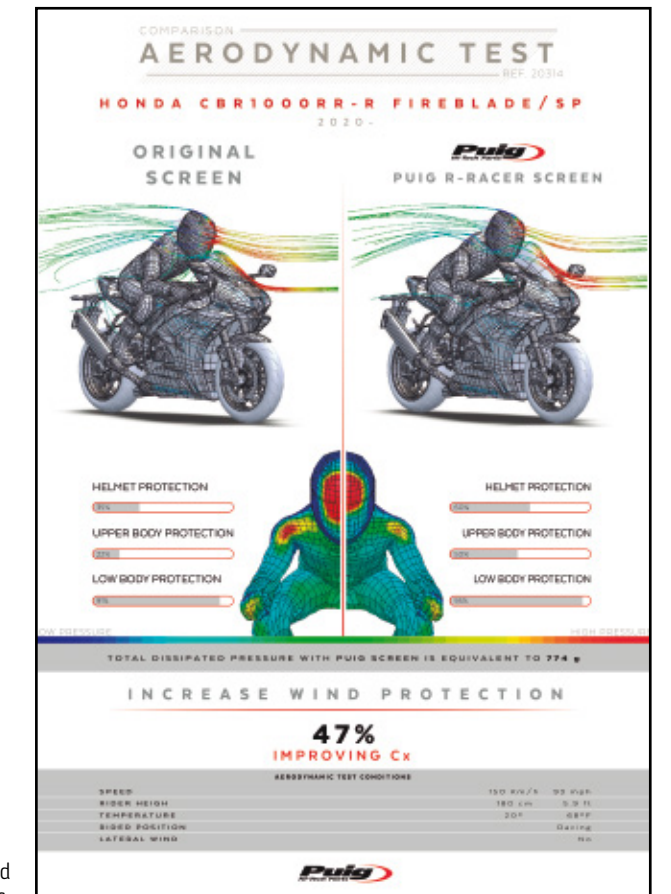

Aerodynamic test delivered with almost all our screens.
Check our website.

FOR SPECIFIC MODELS SEE PAGE 58.

WINDSCREEN MODELS

HI-TECH PARTS | TYPE OF WINDSCREEN:



RACING

Doble height Windscren, it drives the air away from your helmet, for supersport bikes.



TOURING

Windscreen taller than the original to provide more protection to the rider.



NG SPORT / TOURING

Windscreen with adaptor specifically designed for motorcycles that do not have a screen, especially for Naked models.



STANDARD

Windscreen without supports, form and height are the same as the original windscreen.

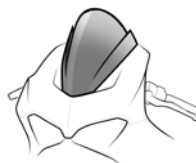

Z-RACING

Windscreen with edges in Z form that drives the air away from the helmet. Slightly taller than the original. Wide range of colors.



TOURING PLUS

Windscreen larger than the Puig Touring model, for certain models of motorcycle tourer for maximum aerodynamic protection.



TOURING WITH VISOR "CLIP ON"

Higher windscreen than the original to which is assigned a multi-adjustable visor that is fixed with a system called "clip-on" to divert the air from the rider and provide maximum comfort when driving.



SPORT

Windscreen without supports, lower than the original windscreen.



R-RACER

Windscreen that comes from competition, without edges. Significantly taller than the original one. Available in smoked colors.



TOURING WITH VISOR

Higher windscreen than the original that incorporates a multi-adjustable screwed visor to divert air from the rider and provide comfort.



ADJUSTABLE

Windscreen that can be adjusted in height, with or without tools and adjust it to the most suitable position for each rider / situation.

WINDSCREEN MODELS

HI-TECH PARTS | TYPE OF WINDSCREEN:

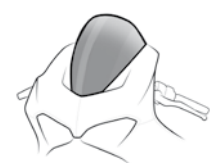

STANDARD
Windscreen without supports, form and height are the same as the original windscreen.



SPORT
Windscreen without supports, lower than the original windscreen.



RACING
Doble height Windscreen, it drives the air away from your helmet, for supersport bikes.

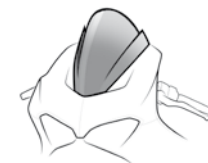

Z-RACING
Windscreen with edges in Z form that drives the air away from the helmet. Slightly taller than the original. Wide range of colors.



R-RACER
Windscreen that comes from competition, without edges. Significantly taller than the original one. Available in smoked colors.



NG SPORT / TOURING
Windscreen with adaptor specifically designed for motorcycles that do not have a screen, especially for Naked models.



TOURING
Windscreen taller than the original to provide more protection to the rider.



TOURING PLUS
Windscreen larger than the Puig Touring model, for certain models of motorcycle tourer for maximum aerodynamic protection.



TOURING WITH VISOR
Higher windscreen than the original that incorporates a multi-adjustable screwed visor to divert air from the rider and provide comfort.



TOURING WITH VISOR "CLIP ON"
Higher windscreen than the original to which is assigned a multi-adjustable visor that is fixed with a system called "clip-on" to divert the air from the rider and provide maximum comfort when driving.



ADJUSTABLE
Windscreen that can be adjusted in height, with or without tools and adjust it to the most suitable position for each rider / situation.

2022		For the new 2022 motorcycle models check www.puig.tv							
MODEL	YEAR	TYPE OF WINDSCREEN	REF.	DIMENSIONS (Height x Width)	HEIGHT (mm) Compared to OEM	THICKNESS (mm)	N W G R T F H A V C		
APRILIA									
CAPONORD 1200	13' - 16'	TOURING	6484	590 x 440	+150	4	(*) (*)		
CAPONORD 1200	13' - 16'	TOURING SCREEN WITH VISOR BOLT-ON	6502H				(*)		
CAPONORD 1200	13' - 16'	TOURING SCREEN WITH CLIP-ON VISOR	6484 + 6320				(*)		
CAPONORD 1200 RALLY	15' - 16'	TOURING	6484	590 x 440	+150	4	(*) (*)		
CAPONORD 1200 RALLY	15' - 16'	TOURING SCREEN WITH VISOR BOLT-ON	6502H				(*)		
CAPONORD 1200 RALLY	15' - 16'	TOURING SCREEN WITH CLIP-ON VISOR	6484 + 6320				(*)		
DORSODURO 750	08' - 16'	NG SPORT / TOURING	SEE PAGE 128						
DORSODURO 900	17' - 21'	NG SPORT / TOURING	SEE PAGE 128						
DORSODURO 1200	11' - 16'	NG SPORT / TOURING	SEE PAGE 128						
PEGASO STRADA 650	05' - 10'	TOURING	2165	410 x 350	+40	3	(*)		
PEGASO TRAIL 650	06' - 09'	TOURING	2165	410 x 350	+40	3	(*)		
RS 50/ RS 125/ RS 250	99' - 05'	RACING	1091	320 x 380		3	(*) (*)		
RS 50/ RS 125	06' - 10'	RACING	4183	400 x 300		3	(*) (*)		
RS4 50/RS4 125	11' - 18'	Z-RACING	4945	365 x 270		3	(*) (*)		
RSV4	09' - 12'	Z-RACING	4945	365 x 270		3	(*) (*)		
RSV4 FACTORY	13' - 14'	Z-RACING	4945	365 x 270		3	(*) (*)		
RSV4 R	13' - 14'	Z-RACING	4945	365 x 270		3	(*) (*)		
RSV4 RF/RR	15' - 20'	Z-RACING	7614	390 x 250	+30	3	(*) (*)		
RSV4 E5/ RSV4 FACTORY E5	21'	R-RACER	20771				(*)		
RS 660	21'	R-RACER	20571	330 x 255	+70	3	(*)		
SHIVER 750	07' - 09'	NG SPORT / TOURING	SEE PAGE 128						
SHIVER 750	10' - 16'	Z-RACING	5249	350 x 330	+180	3	(*)		
SHIVER 900	17' - 21'	NG SPORT / TOURING	SEE PAGE 128						
TUONO 125	17' - 21'	Z-RACING	7615	320 x 270	+30	3	(*)		
TUONO 660	21'	Z-RACING	20794	350 x 285	+55	3	(*)		

2022		For the new 2022 motorcycle models check www.puig.tv							
MODEL	YEAR	TYPE OF WINDSCREEN	REF.	DIMENSIONS (Height x Width)	HEIGHT (mm) Compared to OEM	THICKNESS (mm)	N W G R T F H A V C		
TUONO 1000R	06' - 10'	Z-RACING	4110	400 x 270		3	(*) (*)		
TUONO V4R	11' - 14'	Z-RACING	5647	375 x 300	+185	3	(*) (*)		
TUONO V4 1100 RR	15' - 20'	Z-RACING	7615	320 x 270	+30	3	(*)		
TUONO V4 1100 FACTORY	15' - 20'	Z-RACING	7615	320 x 270	+30	3	(*)		
BENELLI									
502C	19' - 21'	NG SPORT / TOURING	SEE PAGE 128						
BN 752S	18' - 21'	NG SPORT / TOURING	SEE PAGE 128						
LEONCINO 500	16' - 21'	NG SPORT / TOURING	SEE PAGE 128						
LEONCINO TRAIL	17' - 21'	NG SPORT / TOURING	SEE PAGE 128						
TORNADO 302R	14' - 21'	TOURING	9591	373 x 340	+40	3	(*) (*)		
TRK 251	20' - 21'	TOURING	20629	580 x 340	+100		(*)		
TRK 251	20' - 21'	TOURING SCREEN WITH VISOR BOLT-ON	20630H				(*)		
TRK 251	20' - 21'	TOURING SCREEN WITH CLIP-ON VISOR	20629 + 6320				(*)		
TRK 502	16' - 21'	TOURING	9485	555 x 385	+110	4	(*)		
TRK 502	16' - 21'	TOURING SCREEN WITH VISOR BOLT-ON	9508H				(*)		
TRK 502	16' - 21'	TOURING SCREEN WITH CLIP-ON VISOR	9485 + 6375				(*)		
TRK 502 X	16' - 21'	TOURING	9485	555 x 385	+110	4	(*)		
TRK 502 X	16' - 21'	TOURING SCREEN WITH VISOR BOLT-ON	9508H				(*)		
TRK 502 X	16' - 21'	TOURING SCREEN WITH CLIP-ON VISOR	9485 + 6375				(*)		

ANODIZED ALUMINIUM SCREWS AVAILABLE SEE PAGE 102.

R Red
 V Green
 W Transparent
 C Carbon look

T Orange
 A Blue
 H Smoke

G Yellow
 N Black
 F Dark Smoke

CARBON LOOK: RACING SCREEN AVAILABLE ONLY.
NOTE COLORS: N COLOR DELIVERED WITHOUT SILK PRINT.

(-) Adjustable in width and height.
(*) Check price with your distributor.
IMPORTANT: Indicate code color after part#. Example 0973A.

WINDSCREEN MODELS

HI-TECH PARTS | TYPE OF WINDSCREEN:

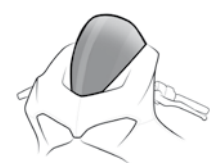

STANDARD

Windscreen without supports, form and height are the same as the original windscreen.



SPORT

Windscreen without supports, lower than the original windscreen.



RACING

Doble height Windscreen, it drives the air away from your helmet, for supersport bikes.



Z-RACING

Windscreen with edges in Z form that drives the air away from the helmet. Slightly taller than the original. Wide range of colors.



R-RACER

Windscreen that comes from competition, without edges. Significantly taller than the original one. Available in smoked colors.



NG SPORT / TOURING

Windscreen with adaptor specifically designed for motorcycles that do not have a screen, especially for Naked models.



TOURING

Windscreen taller than the original to provide more protection to the rider.

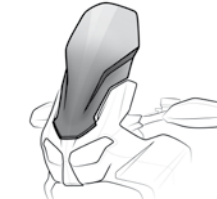

TOURING PLUS

Windscreen larger than the Puig Touring model, for certain models of motorcycle tourer for maximum aerodynamic protection.



TOURING WITH VISOR

Higher windscreen than the original that incorporates a multi-adjustable screwed visor to divert air from the rider and provide comfort.



TOURING WITH VISOR "CLIP ON"

Higher windscreen than the original to which is assigned a multi-adjustable visor that is fixed with a system called "clip-on" to divert the air from the rider and provide maximum comfort when driving.



ADJUSTABLE

Windscreen that can be adjusted in height, with or without tools and adjust it to the most suitable position for each rider / situation.

2022		For the new 2022 motorcycle models check www.puig.tv							
MODEL	YEAR	TYPE OF WINDSCREEN	REF.	DIMENSIONS (Height x Width)	HEIGHT (mm) Compared to OEM	THICKNESS (mm)	N W F H	G R T A V C	
BMW									
F650GS	04' - 07'	TOURING	2015	440 x 305	+30	4	(*)		
F650GS	08' - 12'	TOURING	4670	300 x 200	+120	3	(*)	(*)	
F650GS	08' - 12'	TOURING SCREEN WITH VISOR BOLT-ON	5914H				(*)		
F650GS	08' - 12'	TOURING SCREEN WITH CLIP-ON VISOR	4670 + 6320				(*)		
F650ST	93' - 00'	TOURING	0307	500 x 410	+70	3	(*)		
F700GS	12' - 17'	TOURING	6365	490 x 400	+220	3	(*)	(*)	
F750GS	18' - 21'	TOURING	3768	410 x 365	+183	4	(*)		
F750GS	18' - 21'	TOURING SCREEN WITH VISOR BOLT-ON	3832H				(*)		
F750GS	18' - 21'	TOURING SCREEN WITH CLIP-ON VISOR	3768+ 6319				(*)		
F750GS	18' - 21'	TOURING PLUS	9770	540 x 415	+295	4	(*)		
F750GS	18' - 21'	TOURING PLUS SCREEN WITH VISOR BOLT-ON	9771H				(*)		
F750GS	18' - 21'	TOURING PLUS SCREEN WITH CLIP-ON VISOR	9770 + 6320				(*)		
F750GS	18' - 21'	ADJUSTABLE	3178	490 x 420	+325	4	(*)		
F800GT	13' - 20'	TOURING	6485	610 x 370	+140	3	(*)	(*)	
F800GT	13' - 20'	TOURING SCREEN WITH VISOR BOLT-ON	6503H				(*)		
F800GT	13' - 20'	TOURING SCREEN WITH CLIP-ON VISOR	6485 + 6375				(*)		
F800GS	08' - 17'	TOURING	4670	300 x 200	+120	3	(*)	(*)	
F800GS	08' - 17'	TOURING SCREEN WITH VISOR BOLT-ON	5914H				(*)		
F800GS	08' - 17'	TOURING SCREEN WITH CLIP-ON VISOR	4670 + 6320				(*)		

2022		For the new 2022 motorcycle models check www.puig.tv							
MODEL	YEAR	TYPE OF WINDSCREEN	REF.	DIMENSIONS (Height x Width)	HEIGHT (mm) Compared to OEM	THICKNESS (mm)	N W F H	G R T A V C	
F800GS ADVENTURE	13' - 18'	ADJUSTABLE	7307	380 x 345	+155	4	(*)		
F800R	09' - 20'	NG SPORT / TOURING	SEE PAGE 128						
F800S	06' - 11'	TOURING	4376	390 x 330		3	(*)		
F800ST	06' - 13'	TOURING	4376	390 x 330		3	(*)		
F850GS	18' - 21'	TOURING	3769	410 x 365	+90	4	(*)		
F850GS	18' - 21'	TOURING SCREEN WITH VISOR BOLT-ON	3831H				(*)		
F850GS	18' - 21'	TOURING SCREEN WITH CLIP-ON VISOR	3769+6319				(*)		
F850GS	18' - 21'	TOURING PLUS	3595	540 x 415	+220	4	(*)		
F850GS	18' - 21'	TOURING PLUS SCREEN WITH VISOR BOLT-ON	3597H				(*)		
F850GS	18' - 21'	TOURING PLUS SCREEN WITH CLIP-ON VISOR	3595 + 6320				(*)		
F850GS	18' - 21'	ADJUSTABLE	3179	490 x 420	+255	4	(*)		
F850GS ADVENTURE	19' - 21'	TOURING	3769	410 x 365	+90	4	(*)		
F850GS ADVENTURE	19' - 21'	TOURING SCREEN WITH VISOR BOLT-ON	3831H				(*)		
F850GS ADVENTURE	19' - 21'	TOURING SCREEN WITH CLIP-ON VISOR	3769+6319				(*)		
F850GS ADVENTURE	19' - 21'	ADJUSTABLE	3179	490 x 420	+255	4	(*)		
F850GS ADVENTURE	19' - 21'	TOURING PLUS	3595	530 x 415	+220	4	(*)		
F850GS ADVENTURE	19' - 21'	TOURING SCREEN WITH VISOR BOLT-ON	3597H				(*)		

R Red	V Green	W Transparent	C Carbon look
T Orange	A Blue	H Smoke	
G Yellow	N Black	F Dark Smoke	

ANODIZED ALUMINIUM SCREWS AVAILABLE SEE PAGE 102.

CARBON LOOK: RACING SCREEN AVAILABLE ONLY.
NOTE COLORS: N COLOR DELIVERED WITHOUT SILK PRINT.

(-) Adjustable in width and height.

(*) Check price with your distributor.

IMPORTANT: Indicate code color after part#. Example 0973A.

WINDSCREEN MODELS

HI-TECH PARTS | TYPE OF WINDSCREEN:

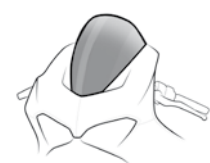

STANDARD

Windscreen without supports, form and height are the same as the original windscreen.



SPORT

Windscreen without supports, lower than the original windscreen.



RACING

Doble height Windscreen, it drives the air away from your helmet, for supersport bikes.



Z-RACING

Windscreen with edges in Z form that drives the air away from the helmet. Slightly taller than the original. Wide range of colors.



R-RACER

Windscreen that comes from competition, without edges. Significantly taller than the original one. Available in smoked colors.

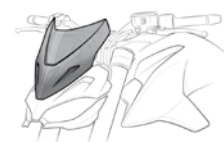

NG SPORT / TOURING

Windscreen with adaptor specifically designed for motorcycles that do not have a screen, especially for Naked models.



TOURING

Windscreen taller than the original to provide more protection to the rider.



TOURING PLUS

Windscreen larger than the Puig Touring model, for certain models of motorcycle tourer for maximum aerodynamic protection.



TOURING WITH VISOR

Higher windscreen than the original that incorporates a multi-adjustable screwed visor to divert air from the rider and provide comfort.



TOURING WITH VISOR "CLIP ON"

Higher windscreen than the original to which is assigned a multi-adjustable visor that is fixed with a system called "clip-on" to divert the air from the rider and provide maximum comfort when driving.

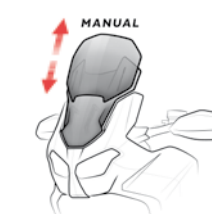

ADJUSTABLE

Windscreen that can be adjusted in height, with or without tools and adjust it to the most suitable position for each rider / situation.

2022		For the new 2022 motorcycle models check www.puig.tv					
MODEL	YEAR	TYPE OF WINDSCREEN	REF.	DIMENSIONS (Height x Width)	HEIGHT (mm) Compared to OEM	THICKNESS (mm)	N W G R T F H A V C
F850GS ADVENTURE	19' - 21'	TOURING SCREEN WITH CLIP-ON VISOR	3595+6320				(*)
F900R	20' - 21'	NG SPORT / TOURING	SEE PAGE 128				(*)
F900XR	20' - 21'	SPORT	20429	378 x 335	-80	4	(*)
F900XR	20' - 21'	TOURING	20391	565 x 360	+125	4	(*)
F900XR	20' - 21'	TOURING SCREEN WITH VISOR BOLT-ON	20392H				(*)
F900XR	20' - 21'	TOURING SCREEN WITH CLIP-ON VISOR	20391 + 6320				(*)
G310GS	17' - 21'	TOURING	9879	430 x 340	+180	3	(*)
G310GS	17' - 21'	TOURING SCREEN WITH VISOR BOLT-ON	9880H				(*)
G310GS	17' - 21'	TOURING SCREEN WITH CLIP-ON VISOR	9879 + 6320				(*)
G310R	16' - 20'	NG SPORT / TOURING	SEE PAGE 129				(*)
G650GS	10'	TOURING	2015	440 x 305	+30	4	(*)
G650GS	11' - 16'	TOURING	5649(-)	420 x 450	+205	3	(*)
G650GS	11' - 16'	TOURING SCREEN WITH VISOR BOLT-ON	5915H (-)				(*)
G650GS	11' - 16'	TOURING SCREEN WITH CLIP-ON VISOR	5649 + 6319				(*)
K1200S	04' - 08'	TOURING	2207	430 x 430		3	(*) (*)
K1300R	09' - 16'	NG SPORT / TOURING	SEE PAGE 129				(*)
K1300S	09' - 16'	TOURING	2207	430 x 430		3	(*) (*)
K1600 GT	11' - 21'	TOURING	9512	695 x 680	+105	4	(*)
K1600 GT	11' - 21'	TOURING SCREEN WITH VISOR BOLT-ON	9513H				(*)
K1600 GT	11' - 21'	TOURING SCREEN WITH CLIP-ON VISOR	9512 + 6375				(*)
K1600 GTL	11' - 21'	TOURING	9512	695 x 680	+105	4	(*)

2022		For the new 2022 motorcycle models check www.puig.tv					
MODEL	YEAR	TYPE OF WINDSCREEN	REF.	DIMENSIONS (Height x Width)	HEIGHT (mm) Compared to OEM	THICKNESS (mm)	N W G R T F H A V C
K1600 GTL	11' - 21'	TOURING SCREEN WITH VISOR BOLT-ON	9513H				(*)
K1600 GTL	11' - 21'	TOURING SCREEN WITH CLIP-ON VISOR	9512 + 6375				(*)
K1600 GRAND AMERICA	18' - 21'	TOURING	9512	695 x 680	+105	4	(*)
K1600 GRAND AMERICA	18' - 21'	TOURING SCREEN WITH VISOR BOLT-ON	9513H				(*)
K1600 GRAND AMERICA	18' - 21'	TOURING SCREEN WITH CLIP-ON VISOR	9512 + 6375				(*)
R NINE T RACER	17' - 20'	TOURING	9402	385 x 360	+25	3	(*)
R1200GS	04' - 12'	TOURING	4331	530 x 460	+130	4	(*)
R1200GS	04' - 12'	TOURING SCREEN WITH VISOR BOLT-ON	5916H				(*)
R1200GS	04' - 12'	TOURING SCREEN WITH CLIP-ON VISOR	4331 + 6319				(*)
R1200GS	13' - 16'	SPORT	7550	115 x 240		4	(*)
R1200GS	13' - 18'	SPORT	6487	320 x 340	-120	4	(*)
R1200GS	13' - 18'	TOURING	6486	545 x 445	+110	4	(*)
R1200GS	13' - 18'	TOURING SCREEN WITH VISOR BOLT-ON	6504H				(*)
R1200GS	13' - 18'	TOURING SCREEN WITH CLIP-ON VISOR	6486 + 6375				(*)
R1200GS	13' - 18'	FIXING SUPPORT REF.6486	7566N				(*)
R1200GS EXCLUSIVE	17' - 18'	SPORT	6487	320 x 340	-120	4	(*)
R1200GS EXCLUSIVE	17' - 18'	TOURING	6486	545 x 585	+110	4	(*)

ANODIZED ALUMINIUM SCREWS AVAILABLE SEE PAGE 102.

R Red
 V Green
 W Transparent
 C Carbon look

T Orange
 A Blue
 H Smoke

G Yellow
 N Black
 F Dark Smoke

CARBON LOOK: RACING SCREEN AVAILABLE ONLY.
NOTE COLORS: N COLOR DELIVERED WITHOUT SILK PRINT.

(-) Adjustable in width and height.

(*) Check price with your distributor.

IMPORTANT: Indicate code color after part#. Example 0973A.

WINDSCREEN MODELS

HI-TECH PARTS | TYPE OF WINDSCREEN:



STANDARD
Windscreen without supports, form and height are the same as the original windscreen.



SPORT
Windscreen without supports, lower than the original windscreen.



RACING
Doble height Windscreen, it drives the air away from your helmet, for supersport bikes.

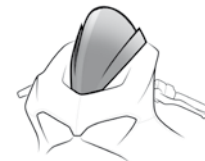

Z-RACING
Windscreen with edges in Z form that drives the air away from the helmet. Slightly taller than the original. Wide range of colors.



R-RACER
Windscreen that comes from competition, without edges. Significantly taller than the original one. Available in smoked colors.



NG SPORT / TOURING
Windscreen with adaptor specifically designed for motorcycles that do not have a screen, especially for Naked models.



TOURING
Windscreen taller than the original to provide more protection to the rider.

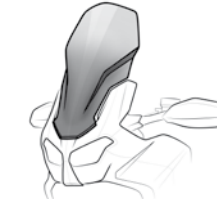

TOURING PLUS
Windscreen larger than the Puig Touring model, for certain models of motorcycle tourer for maximum aerodynamic protection.



TOURING WITH VISOR
Higher windscreen than the original that incorporates a multi-adjustable screwed visor to divert air from the rider and provide comfort.



TOURING WITH VISOR "CLIP ON"
Higher windscreen than the original to which is assigned a multi-adjustable visor that is fixed with a system called "clip-on" to divert the air from the rider and provide maximum comfort when driving.



ADJUSTABLE
Windscreen that can be adjusted in height, with or without tools and adjust it to the most suitable position for each rider / situation.

2022		For the new 2022 motorcycle models check www.puig.tv					
MODEL	YEAR	TYPE OF WINDSCREEN	REF.	DIMENSIONS (Height x Width)	HEIGHT (mm) Compared to OEM	THICKNESS (mm)	N W G R T F H A V C
R1200GS EXCLUSIVE	17' - 18'	TOURING SCREEN WITH VISOR BOLT-ON	6504H				(*)
R1200GS EXCLUSIVE	17' - 18'	TOURING SCREEN WITH CLIP-ON VISOR	6486 + 6375				(*)
R1200GS EXCLUSIVE	17' - 18'	FIXING SUPPORT REF.6486	7566N				(*)
R1200GS RALLYE	17' - 18'	SPORT	6487	320 x 340	-120	4	(*)
R1200GS RALLYE	17' - 18'	TOURING	6486	545 x 445	+110	4	(*)
R1200GS RALLYE	17' - 18'	TOURING SCREEN WITH VISOR BOLT-ON	6504H				(*)
R1200GS RALLYE	17' - 18'	TOURING SCREEN WITH CLIP-ON VISOR	6486 + 6375				(*)
R1200GS RALLYE	17' - 18'	FIXING SUPPORT REF.6486	7566N				(*)
R1200GS ADVENTURE	14' - 18'	SPORT	6487	320 x 340	-120	4	(*)
R1200GS ADVENTURE	14' - 18'	TOURING	6486	545 x 445	+110	4	(*)
R1200GS ADVENTURE	14' - 18'	TOURING SCREEN WITH VISOR BOLT-ON	6504H				(*)
R1200GS ADVENTURE	14' - 18'	TOURING SCREEN WITH CLIP-ON VISOR	6486 + 6375				(*)
R1200GS ADVENTURE	14' - 18'	FIXING SUPPORT REF.6486	7566N				(*)
R1200GS ADVENTURE	14' - 18'	SPORT	7550	115 x 240		4	(*)
R1200R	06' - 18'	NG SPORT / TOURING	SEE PAGE 129				
R1200RS	15' - 18'	TOURING	7616	440 x 390	+20	4	(*) (*)
R1200RS	15' - 18'	TOURING PLUS	7617	550 x 410	+95	4	(*)
R1200RS	15' - 18'	TOURING PLUS SCREEN WITH VISOR BOLT-ON	7618H				(*)
R1200RS	15' - 18'	TOURING PLUS SCREEN WITH CLIP-ON VISOR	7617 + 6320				(*)
R1200RT	14' - 18'	TOURING	9512	695 x 680	+105	4	(*)
R1200RT	14' - 18'	TOURING SCREEN WITH VISOR BOLT-ON	9513H				(*)

2022		For the new 2022 motorcycle models check www.puig.tv					
MODEL	YEAR	TYPE OF WINDSCREEN	REF.	DIMENSIONS (Height x Width)	HEIGHT (mm) Compared to OEM	THICKNESS (mm)	N W G R T F H A V C
R1200RT	14' - 18'	TOURING SCREEN WITH CLIP-ON VISOR	9512 + 6375				(*)
R1250RT	21'	TOURING	20774	690 x 675	+80	4	(*)
R1250RT	21'	TOURING SCREEN WITH VISOR BOLT-ON	20775H				(*)
R1250RT	21'	TOURING SCREEN WITH CLIP-ON VISOR	20774 + 20764				(*)
R1200S	06' - 08'	TOURING	4375	340 x 340		3	(*)
R1250GS	18' - 21'	SPORT	6487	320 x 340	-120	4	(*)
R1250GS	18' - 21'	TOURING	6486	545 x 445	+110	4	(*)
R1250GS	18' - 21'	TOURING SCREEN WITH VISOR BOLT-ON	6504H				(*)
R1250GS	18' - 21'	TOURING SCREEN WITH CLIP-ON VISOR	6486 + 6375				(*)
R1250GS	18' - 21'	FIXING SUPPORT REF.6486	7566N				(*)
R1250GS HP	18' - 21'	SPORT	6487	320 x 340	-120	4	(*)
R1250GS HP	18' - 21'	TOURING	6486	545 x 445	+110	4	(*)
R1250GS HP	18' - 21'	TOURING SCREEN WITH VISOR BOLT-ON	6504H				(*)
R1250GS HP	18' - 21'	TOURING SCREEN WITH CLIP-ON VISOR	6486+6375				(*)
R1250GS HP	18' - 21'	FIXING SUPPORT REF.6486	7566N				(*)
R1250GS ADVENTURE	18' - 21'	SPORT	6487	320 x 340	-120	4	(*)
R1250GS ADVENTURE	18' - 21'	TOURING	6486	545 x 445	+110	4	(*)

R Red
 V Green
 W Transparent
 C Carbon look

T Orange
 A Blue
 H Smoke

G Yellow
 N Black
 F Dark Smoke

ANODIZED ALUMINIUM SCREWS AVAILABLE SEE PAGE 102.

CARBON LOOK: RACING SCREEN AVAILABLE ONLY.
NOTE COLORS: N COLOR DELIVERED WITHOUT SILK PRINT.

(-) Adjustable in width and height.
(*) Check price with your distributor.
IMPORTANT: Indicate code color after part#. Example 0973A.

WINDSCREEN MODELS

HI-TECH PARTS | TYPE OF WINDSCREEN:



STANDARD

Windscreen without supports, form and height are the same as the original windscreen.



SPORT

Windscreen without supports, lower than the original windscreen.



RACING

Doble height Windscreen, it drives the air away from your helmet, for supersport bikes.



Z-RACING

Windscreen with edges in Z form that drives the air away from the helmet. Slightly taller than the original. Wide range of colors.



R-RACER

Windscreen that comes from competition, without edges. Significantly taller than the original one. Available in smoked colors.



NG SPORT / TOURING

Windscreen with adaptor specifically designed for motorcycles that do not have a screen, especially for Naked models.



TOURING

Windscreen taller than the original to provide more protection to the rider.

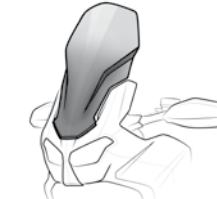

TOURING PLUS

Windscreen larger than the Puig Touring model, for certain models of motorcycle tourer for maximum aerodynamic protection.



TOURING WITH VISOR

Higher windscreen than the original that incorporates a multi-adjustable screwed visor to divert air from the rider and provide comfort.



TOURING WITH VISOR "CLIP ON"

Higher windscreen than the original to which is assigned a multi-adjustable visor that is fixed with a system called "clip-on" to divert the air from the rider and provide maximum comfort when driving.



ADJUSTABLE

Windscreen that can be adjusted in height, with or without tools and adjust it to the most suitable position for each rider / situation.

2022		For the new 2022 motorcycle models check www.puig.tv						
MODEL	YEAR	TYPE OF WINDSCREEN	REF.	DIMENSIONS (Height x Width)	HEIGHT (mm) Compared to OEM	THICKNESS (mm)	N W G R T F H A V C	
R1250GS ADVENTURE	18' - 21'	TOURING SCREEN WITH VISOR BOLT-ON	6504H				(*)	
R1250GS ADVENTURE	18' - 21'	TOURING SCREEN WITH CLIP-ON VISOR	6486+6375				(*)	
R1250GS ADVENTURE	18' - 21'	FIXING SUPPORT REF.6486	7566N				(*)	
R1250GS RALLYE	18' - 21'	SPORT	6487	320 x 340	-120	4	(*)	
R1250GS RALLYE	18' - 21'	TOURING	6486	545 x 445	+110	4	(*)	
R1250GS RALLYE	18' - 21'	TOURING SCREEN WITH VISOR BOLT-ON	6504H				(*)	
R1250GS RALLYE	18' - 21'	TOURING SCREEN WITH CLIP-ON VISOR	6486+6375				(*)	
R1250GS RALLYE	18' - 21'	FIXING SUPPORT REF.6486	7566N				(*)	
R1250 R	19' - 21'	NG SPORT / TOURING	SEE PAGE 129					
R1250RS	19' - 21'	TOURING	7616	440 x 390	+20	4	(*)	
R1250RS	19' - 21'	TOURING PLUS	7617	550 x 410	+95	4	(*)	
R1250RS	19' - 21'	TOURING PLUS SCREEN WITH VISOR BOLT-ON	7618H				(*)	
R1250RS	19' - 21'	TOURING PLUS SCREEN WITH CLIP-ON VISOR	7617 + 6320				(*)	
R1250RT	19' - 20'	TOURING	9512	695 x 680	+105	4	(*)	
R1250RT	19' - 20'	TOURING SCREEN WITH VISOR BOLT-ON	9513H				(*)	
R1250RT	19' - 20'	TOURING SCREEN WITH CLIP-ON VISOR	9512+6375				(*)	
R18	20' - 21'	NG SPORT / TOURING	SEE PAGE 129					
S1000R	14' - 18'	NG SPORT / TOURING	SEE PAGE 129					
S1000RR	09' - 14'	Z-RACING	5205	430 x 300		3	(*) (*)	
S1000RR	15' - 18'	Z-RACING	7564	360 x 440	+30	3	(*) (*)	
S1000RR	19' - 21'	Z-RACING	3571	445 x 425	+40	3	(*) (*)	
S1000RR	19' - 21'	R-RACER	3641	450 x 430	+70	3	(*)	

2022		For the new 2022 motorcycle models check www.puig.tv						
MODEL	YEAR	TYPE OF WINDSCREEN	REF.	DIMENSIONS (Height x Width)	HEIGHT (mm) Compared to OEM	THICKNESS (mm)	N W G R T F H A V C	
M1000RR	20' - 21'	Z-RACING	3571	445 x 425			(*)	
M1000RR	20' - 21'	R-RACER	3641	450 x 430	+70	3	(*)	
S1000XR	15' - 19'	SPORT	8543	390 x 345	-30	4	(*) (*)	
S1000XR	15' - 19'	TOURING	7619	515 x 425	+105	4	(*)	
S1000XR	15' - 19'	TOURING SCREEN WITH VISOR BOLT-ON	7620H				(*)	
S1000XR	15' - 19'	TOURING SCREEN WITH CLIP-ON VISOR	7619 + 6320				(*)	
S1000XR	20' - 21'	SPORT	20460	378 x 335	-60	4	(*)	
S1000XR	20' - 21'	TOURING	20447	565 x 360	+170	4	(*)	
S1000XR	20' - 21'	TOURING SCREEN WITH VISOR BOLT-ON	20456H				(*)	
S1000XR	20' - 21'	TOURING SCREEN WITH CLIP-ON VISOR	20447+ 6320				(*)	
DUCATI								
749R/749/749S/999/999S/999R	05' - 06'	RACING	2541	420 x 330		3	(*)	
916S/996/998/748		RACING	0955	340 x 310		3	(*)	
848	08' - 10'	RACING	4667	435 x 330		3	(*) (*)	
899 PANIGALE	14' - 15'	R-RACER	5990	400 x 250		3	(*)	
959 PANIGALE	16' - 20'	R-RACER	7621	370 x 250	+30	3	(*)	
959 PANIGALE CORSE	18' - 20'	R-RACER	7621	370 x 250	+30	3	(*)	
1098/1098R/1098S	07' - 08'	Z-RACING	4667	435 x 330		3	(*) (*)	
1198/1198R/1198S	09' - 11'	Z-RACING	4667	435 x 330		3	(*) (*)	
1199 PANIGALE/S	12' - 15'	R-RACER	5990	400 x 250		3	(*)	
1199 PANIGALE R	15' - 17'	R-RACER	5990	400 x 250		3	(*)	

ANODIZED ALUMINIUM SCREWS AVAILABLE SEE PAGE 102.

R Red	V Green	W Transparent	C Carbon look
T Orange	A Blue	H Smoke	
G Yellow	N Black	F Dark Smoke	

CARBON LOOK: RACING SCREEN AVAILABLE ONLY. NOTE COLORS: N COLOR DELIVERED WITHOUT SILK PRINT.

(-) Adjustable in width and height. (*) Check price with your distributor.

IMPORTANT: Indicate code color after part#. Example 0973A.

WINDSCREEN MODELS

HI-TECH PARTS | TYPE OF WINDSCREEN:

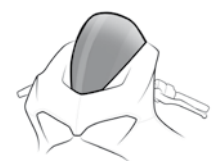

STANDARD

Windscreen without supports, form and height are the same as the original windscreen.



SPORT

Windscreen without supports, lower than the original windscreen.



RACING

Doble height Windscreen, it drives the air away from your helmet, for supersport bikes.

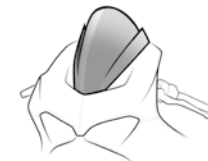

Z-RACING

Windscreen with edges in Z form that drives the air away from the helmet. Slightly taller than the original. Wide range of colors.



R-RACER

Windscreen that comes from competition, without edges. Significantly taller than the original one. Available in smoked colors.



NG SPORT / TOURING

Windscreen with adaptor specifically designed for motorcycles that do not have a screen, especially for Naked models.



TOURING

Windscreen taller than the original to provide more protection to the rider.



TOURING PLUS

Windscreen larger than the Puig Touring model, for certain models of motorcycle tourer for maximum aerodynamic protection.



TOURING WITH VISOR

Higher windscreen than the original that incorporates a multi-adjustable screwed visor to divert air from the rider and provide comfort.



TOURING WITH VISOR "CLIP ON"

Higher windscreen than the original to which is assigned a multi-adjustable visor that is fixed with a system called "clip-on" to divert the air from the rider and provide maximum comfort when driving.



ADJUSTABLE

Windscreen that can be adjusted in height, with or without tools and adjust it to the most suitable position for each rider / situation.

2022		For the new 2022 motorcycle models check www.puig.tv						
MODEL	YEAR	TYPE OF WINDSCREEN	REF.	DIMENSIONS (Height x Width)	HEIGHT (mm) Compared to OEM	THICKNESS (mm)	N W G R T F H A V C	
1199 SUPERLEGGERA	14'	R-RACER	5990	400 x 250		3	(*)	
1299 PANIGALE/S	15' - 17'	R-RACER	7621	370 x 250	+30	3	(*)	
PANIGALE R	15' - 17'	R-RACER	7621	370 x 250	+30	3	(*)	
PANIGALE V2	20' - 21'	R-RACER	9690	400 x 275	+30	3	(*)	
PANIGALE V2 BAYLISS	21'	R-RACER	9690	400 x 275	+30	3	(*)	
PANIGALE 1100 V4	18' - 19'	R-RACER	9690	400 x 275	+30	3	(*)	
PANIGALE 1100 V4	20' - 21'	R-RACER	3759	195 x 275	+30	3	(*)	
PANIGALE 1100 V4 SP	21'	R-RACER	3759	195 x 275	+30	3	(*)	
PANIGALE 1100 V4 R	18' - 21'	R-RACER	3759	195 x 275	+30	3	(*)	
PANIGALE 1100 V4S	18' - 19'	R-RACER	9690	400 x 275	+30	3	(*)	
PANIGALE 1100 V4S	20' - 21'	R-RACER	3759	195 x 275	+30	3	(*)	
DIAVEL	11' - 18'	NG SPORT / TOURING	SEE PAGE 129					
DIAVEL 1260/S	19' - 21'	NG SPORT / TOURING	SEE PAGE 129					
X DIAVEL/S	16' - 18'	NG SPORT / TOURING	SEE PAGE 129					
HYPERMOTARD 950/SP	19' - 21'	NG SPORT / TOURING	SEE PAGE 129					
HYPERMOTARD 950 RVE	21'	NG SPORT / TOURING	SEE PAGE 129					
MONSTER 696	08' - 14'	NG SPORT / TOURING	SEE PAGE 129					
MONSTER 796	10' - 14'	NG SPORT / TOURING	SEE PAGE 129					
MONSTER 797	17' - 20'	NG SPORT / TOURING	SEE PAGE 129					
MONSTER 797	17' - 20'	SPORT	8900	290X180	+100	3	(*)	
MONSTER 821	14' - 20'	NG SPORT / TOURING	SEE PAGE 129					
MONSTER 821	14' - 20'	SPORT	8900	290X180	+100	3	(*)	
MONSTER 937	21'	NG SPORT / TOURING	SEE PAGE 129					
MONSTER 937	21'	SPORT	20688	240 x 215	+105	3	(*)	
MONSTER 1100/S	09' - 10'	NG SPORT / TOURING	SEE PAGE 129					
MONSTER 1100 EVO	11' - 13'	NG SPORT / TOURING	SEE PAGE 129					
MONSTER 1200/S	14' - 21'	NG SPORT / TOURING	SEE PAGE 129					
MONSTER 1200/S	14' - 21'	SPORT	8900	290X180	+100	3	(*)	
MONSTER 1200 R	16' - 20'	NG SPORT / TOURING	SEE PAGE 129					
MONSTER 1200 R	16' - 20'	SPORT	8900	290X180	+100	3	(*)	

2022		For the new 2022 motorcycle models check www.puig.tv						
MODEL	YEAR	TYPE OF WINDSCREEN	REF.	DIMENSIONS (Height x Width)	HEIGHT (mm) Compared to OEM	THICKNESS (mm)	N W G R T F H A V C	
MULTISTRADA 950	17' - 21'	SPORT	7622	440 x 295	-80	3	(*) (*)	
MULTISTRADA 950	17' - 21'	TOURING	7623	605 x 335	+85	4	(*)	
MULTISTRADA 950	17' - 21'	TOURING SCREEN WITH VISOR BOLT-ON	7624H				(*)	
MULTISTRADA 950	17' - 21'	TOURING SCREEN WITH CLIP-ON VISOR	7623 + 6319				(*)	
MULTISTRADA 950 S	19' - 21'	SPORT	7622	440 x 295	-80	3	(*) (*)	
MULTISTRADA 950 S	19' - 21'	TOURING	7623	605 x 335	+85	4	(*)	
MULTISTRADA 950 S	19' - 21''	TOURING SCREEN WITH VISOR BOLT-ON	7624H				(*)	
MULTISTRADA 950 S	19' - 21'	TOURING SCREEN WITH CLIP-ON VISOR	7623 + 6319				(*)	
MULTISTRADA 1200/S	10' - 12'	TOURING PLUS	5250	573 x 330	+65	3	(*) (*)	
MULTISTRADA 1200/S	13' - 14'	SPORT	6490	430 x 290	-85	4	(*)	
MULTISTRADA 1200/S	13' - 14'	TOURING	6491	580 x 405	+65	4	(*) (*)	
MULTISTRADA 1200/S	13' - 14'	TOURING SCREEN WITH VISOR BOLT-ON	6505H				(*)	
MULTISTRADA 1200/S	13' - 14'	TOURING SCREEN WITH CLIP-ON VISOR	6491 + 6320				(*)	
MULTISTRADA 1200/S	15' - 17'	SPORT	7622	440 x 295	-80	3	(*) (*)	
MULTISTRADA 1200/S	15' - 17'	TOURING	7623	605 x 335	+85	4	(*)	
MULTISTRADA 1200/S	15' - 17'	TOURING SCREEN WITH VISOR BOLT-ON	7624H				(*)	
MULTISTRADA 1200/S	15' - 17'	TOURING SCREEN WITH CLIP-ON VISOR	7623 + 6319				(*)	

ANODIZED ALUMINIUM SCREWS AVAILABLE SEE PAGE 102.

R Red	V Green	W Transparent	C Carbon look
T Orange	A Blue	H Smoke	
G Yellow	N Black	F Dark Smoke	

CARBON LOOK: RACING SCREEN AVAILABLE ONLY.
NOTE COLORS: N COLOR DELIVERED WITHOUT SILK PRINT.

(-) Adjustable in width and height.

(*) Check price with your distributor.

IMPORTANT: Indicate code color after part#. Example 0973A.

WINDSCREEN MODELS

HI-TECH PARTS | TYPE OF WINDSCREEN:

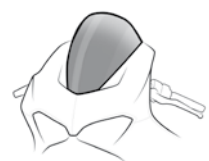

STANDARD

Windscreen without supports, form and height are the same as the original windscreen.



SPORT

Windscreen without supports, lower than the original windscreen.



RACING

Doble height Windscreen, it drives the air away from your helmet, for supersport bikes.



Z-RACING

Windscreen with edges in Z form that drives the air away from the helmet. Slightly taller than the original. Wide range of colors.



R-RACER

Windscreen that comes from competition, without edges. Significantly taller than the original one. Available in smoked colors.



NG SPORT / TOURING

Windscreen with adaptor specifically designed for motorcycles that do not have a screen, especially for Naked models.



TOURING

Windscreen taller than the original to provide more protection to the rider.



TOURING PLUS

Windscreen larger than the Puig Touring model, for certain models of motorcycle tourer for maximum aerodynamic protection.



TOURING WITH VISOR

Higher windscreen than the original that incorporates a multi-adjustable screwed visor to divert air from the rider and provide comfort.



TOURING WITH VISOR "CLIP ON"

Higher windscreen than the original to which is assigned a multi-adjustable visor that is fixed with a system called "clip-on" to divert the air from the rider and provide maximum comfort when driving.



ADJUSTABLE

Windscreen that can be adjusted in height, with or without tools and adjust it to the most suitable position for each rider / situation.

2022		For the new 2022 motorcycle models check www.puig.tv							
MODEL	YEAR	TYPE OF WINDSCREEN	REF.	DIMENSIONS (Height x Width)	HEIGHT (mm) Compared to OEM	THICKNESS (mm)	N W F H	G R T A V C	
MULTISTRADA 1200 ENDURO/PRO	16' - 18'	SPORT	7622	440 x 295	-80	3	(*)	(*)	
MULTISTRADA 1200 ENDURO/PRO	16' - 18'	TOURING	7623	605 x 335	+85	4	(*)		
MULTISTRADA 1200 ENDURO/PRO	16' - 18'	TOURING SCREEN WITH VISOR BOLT-ON	7624H				(*)		
MULTISTRADA 1200 ENDURO/PRO	16' - 18'	TOURING SCREEN WITH CLIP-ON VISOR	7623 + 6319				(*)		
MULTISTRADA 1260/S/S DJAIR	18' - 20'	SPORT	7622	440 x 295	-80	3	(*)	(*)	
MULTISTRADA 1260/S/S DJAIR	18' - 20'	TOURING	7623	605 x 335	+85	4	(*)		
MULTISTRADA 1260/S/S DJAIR	18' - 20'	TOURING SCREEN WITH VISOR BOLT-ON	7624H				(*)		
MULTISTRADA 1260/S/S DJAIR	18' - 20'	TOURING SCREEN WITH CLIP-ON VISOR	7623 + 6319				(*)		
MULTISTRADA 1260 PIKES PEAK	18' - 20'	SPORT	7622	440 x 295	-80	3	(*)	(*)	
MULTISTRADA 1260 PIKES PEAK	18' - 20'	TOURING	7623	605 x 335	+85	4	(*)		
MULTISTRADA 1260 PIKES PEAK	18' - 20'	TOURING SCREEN WITH VISOR BOLT-ON	7624H				(*)		
MULTISTRADA 1260 PIKES PEAK	18' - 20'	TOURING SCREEN WITH CLIP-ON VISOR	7623 + 6319				(*)		
MULTISTRADA 1260 ENDURO	19' - 21'	SPORT	7622	440 x 295	-80	3	(*)	(*)	
MULTISTRADA 1260 ENDURO	19' - 21'	TOURING	7623	605 x 335	+85	4	(*)		
MULTISTRADA 1260 ENDURO	19' - 21'	TOURING SCREEN WITH VISOR BOLT-ON	7624H				(*)		
MULTISTRADA 1260 ENDURO	19' - 21'	TOURING SCREEN WITH CLIP-ON VISOR	7623+6319				(*)		
MULTISTRADA 1260 S GRAND TOUR	20'	SPORT	7622	440 x 295	-80	3	(*)	(*)	
MULTISTRADA 1260 S GRAND TOUR	20'	TOURING	7623	605 x 335	+85	4	(*)		
MULTISTRADA V4/S/S SPORT	21'	SPORT	20729	390 x 365	-90	4	(*)		
MULTISTRADA V4/S/S SPORT	21'	TOURING	20728	630 x 430	+100		(*)		
MULTISTRADA V4/S/S SPORT	21'	TOURING SCREEN WITH VISOR BOLT-ON	20733H				(*)		

2022		For the new 2022 motorcycle models check www.puig.tv							
MODEL	YEAR	TYPE OF WINDSCREEN	REF.	DIMENSIONS (Height x Width)	HEIGHT (mm) Compared to OEM	THICKNESS (mm)	N W F H	G R T A V C	
MULTISTRADA V4/S/S SPORT	21'	TOURING SCREEN WITH CLIP-ON VISOR	20728 + 6375				(*)		
Original fairing MONSTER 696/796/1100		TOURING	5650	260 x 220	+100	3	(*)	(*)	
SUPERSPORT 939/S	17' - 20'	TOURING	9434	405 x 290	+75	3	(*)	(*)	
SUPERSPORT 950/S	21'	TOURING	9434	405 x 290	+75		(*)		
STREETFIGHTER V4/S	19' - 21'	NG SPORT / TOURING	SEE PAGE 129						
HARLEY DAVIDSON									
PAN AMERICA 1250	21'	SPORT	20841				(*)		
PAN AMERICA 1250	21'	TOURING	20840				(*)		
PAN AMERICA 1250	21'	TOURING SCREEN WITH VISOR BOLT-ON	20843H				(*)		
PAN AMERICA 1250	21'	TOURING SCREEN WITH CLIP-ON VISOR	20840 + 6375				(*)		
SPORTSTER 883		NG SPORT / TOURING	SEE PAGE 129						
SPORTSTER 1200		NG SPORT / TOURING	SEE PAGE 130						
SPORTSTER FORTY-EIGHT	10' - 20'	NG SPORT / TOURING	SEE PAGE 130						
SPORTSTER SEVENTY-TWO	13' - 16'	NG SPORT / TOURING	SEE PAGE 130						
HONDA									
CB125F	15' - 18'	NG SPORT / TOURING	SEE PAGE 130						
CB125R NEO SPORTS CAFE	18' - 20'	NG SPORT / TOURING	SEE PAGE 130						
CB300F	15' - 16'	NG SPORT / TOURING	SEE PAGE 130						
CB300R NEO SPORTS CAFE	18' - 21'	NG SPORT / TOURING	SEE PAGE 130						
CB500F	13' - 21'	NG SPORT / TOURING	SEE PAGE 130						
CB500X	13' - 15'	TOURING	6480	485 x 350	+165	3	(*)		

ANODIZED ALUMINIUM SCREWS AVAILABLE SEE PAGE 102.

R Red	V Green	W Transparent	C Carbon look
T Orange	A Blue	H Smoke	
G Yellow	N Black	F Dark Smoke	

CARBON LOOK: RACING SCREEN AVAILABLE ONLY.
NOTE COLORS: N COLOR DELIVERED WITHOUT SILK PRINT.

(-) Adjustable in width and height.

(*) Check price with your distributor.

IMPORTANT: Indicate code color after part#. Example 0973A.

WINDSCREEN MODELS

HI-TECH PARTS | TYPE OF WINDSCREEN:

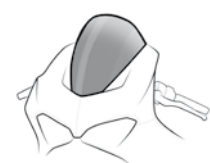

STANDARD

Windscreen without supports, form and height are the same as the original windscreen.



SPORT

Windscreen without supports, lower than the original windscreen.



RACING

Doble height Windscreen, it drives the air away from your helmet, for supersport bikes.

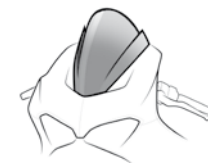

Z-RACING

Windscreen with edges in Z form that drives the air away from the helmet. Slightly taller than the original. Wide range of colors.



R-RACER

Windscreen that comes from competition, without edges. Significantly taller than the original one. Available in smoked colors.



NG SPORT / TOURING

Windscreen with adaptor specifically designed for motorcycles that do not have a screen, especially for Naked models.



TOURING

Windscreen taller than the original to provide more protection to the rider.



TOURING PLUS

Windscreen larger than the Puig Touring model, for certain models of motorcycle tourer for maximum aerodynamic protection.



TOURING WITH VISOR

Higher windscreen than the original that incorporates a multi-adjustable screwed visor to divert air from the rider and provide comfort.



TOURING WITH VISOR "CLIP ON"

Higher windscreen than the original to which is assigned a multi-adjustable visor that is fixed with a system called "clip-on" to divert the air from the rider and provide maximum comfort when driving.



ADJUSTABLE

Windscreen that can be adjusted in height, with or without tools and adjust it to the most suitable position for each rider / situation.

2022		For the new 2022 motorcycle models check www.puig.tv						
MODEL	YEAR	TYPE OF WINDSCREEN	REF.	DIMENSIONS (Height x Width)	HEIGHT (mm) Compared to OEM	THICKNESS (mm)	N W F H	G R T A V C
CB500X	13' - 15'	TOURING SCREEN WITH VISOR BOLT-ON	6992H				(*)	(*)
CB500X	13' - 15'	TOURING SCREEN WITH CLIP-ON VISOR	6480 + 6319				(*)	(*)
CB500X	16' - 21'	TOURING	8901	520 x 310	+105	3	(*)	(*)
CB500X	16' - 21'	TOURING SCREEN WITH VISOR BOLT-ON	8902H				(*)	(*)
CB500X	16' - 21'	TOURING SCREEN WITH CLIP-ON VISOR	8901 + 6319				(*)	(*)
CB650F	14' - 20'	NG SPORT / TOURING	SEE PAGE 130					
CB650R NEO SPORTS CAFE	19' - 21'	NG SPORT / TOURING	SEE PAGE 130					
CB1000R	08' - 10'	NG SPORT / TOURING	SEE PAGE 130					
CB1000R	11' - 16'	NG SPORT / TOURING	SEE PAGE 130					
CB1000R NEO SPORTS CAFE	18' - 21'	NG SPORT / TOURING	SEE PAGE 130					
CB1300S	05' - 13'	TOURING	4098	470 x 320	+100	3	(*)	(*)
CB1300S	05' - 13'	TOURING SCREEN WITH VISOR BOLT-ON	5900H				(*)	(*)
CB1300S	05' - 13'	TOURING SCREEN WITH CLIP-ON VISOR	4098 + 6319				(*)	(*)
CB1300SB	10' - 16'	TOURING	3558	470 x 330	+265	4	(*)	(*)
CBF1000F	10' - 16'	TOURING	5252	470 x 340	+100	3	(*)	(*)
CBF1000F	10' - 16'	TOURING SCREEN WITH VISOR BOLT-ON	5899H				(*)	(*)
CBF1000F	10' - 16'	TOURING SCREEN WITH CLIP-ON VISOR	5252 + 6320				(*)	(*)
CBR125R	11' - 16'	Z-RACING	5641	420 x 280		3	(*)	(*)
CBR250R	11' - 15'	Z-RACING	5643	420 x 340		3	(*)	(*)
CBR300R	15' - 17'	Z-RACING	7228	315 x 240		3	(*)	(*)
CBR500R	13' - 15'	Z-RACING	6479	315x285	+40	3	(*)	(*)
CBR500R	16' - 18'	Z-RACING	8903	330 x 275	+30	3	(*)	(*)

2022		For the new 2022 motorcycle models check www.puig.tv						
MODEL	YEAR	TYPE OF WINDSCREEN	REF.	DIMENSIONS (Height x Width)	HEIGHT (mm) Compared to OEM	THICKNESS (mm)	N W F H	G R T A V C
CBR500R	19' - 21'	Z-RACING	3613	305 x 265	+25	3	(*)	(*)
CBR650R	19' - 21'	Z-RACING	3568	335 x 285	+30	3	(*)	(*)
CBR600RR	05' - 06'	RACING	2058	280 x 320		3	(*)	(*)
CBR600RR	07' - 12'	RACING	4356	340 x 315		3	(*)	(*)
CBR600RR	13' - 16'	Z-RACING	6478	240 x 280	+30	3	(*)	(*)
CBR600F	01' - 07'	RACING	0861	400 x 370		3	(*)	(*)
CBR650F	14' - 20'	Z-RACING	7003	355 x 310	+30	3	(*)	(*)
CBR650F	14' - 20'	TOURING	7595	435 x 375	+110	3	(*)	(*)
CBR650F	14' - 20'	TOURING SCREEN WITH VISOR BOLT-ON	7601H				(*)	(*)
CBR650F	14' - 20'	TOURING SCREEN WITH CLIP-ON VISOR	7595 + 6320				(*)	(*)
CBR1000RR FIRE BLADE	04' - 07'	Z-RACING	1665	370 x 330	+25	3	(*)	(*)
CBR1000RR FIRE BLADE	08' - 11'	STANDARD	4622	290 x 300		3	(*)	(*)
CBR1000RR FIRE BLADE	08' - 11'	RACING	4623	290 x 285		3	(*)	(*)
CBR1000RR FIRE BLADE	12' - 13'	Z-RACING	5994	340 x 300	+40	3	(*)	(*)
CBR1000RR FIREBLADE/SP	14' - 16'	Z-RACING	5994	340 x 300	+40	3	(*)	(*)
CBR1000RR FIREBLADE/SP/SP2	17' - 18'	Z-RACING	9407	330 x 245	+30	3	(*)	(*)
CBR1000RR FIREBLADE/SP/SP2	17' - 19'	R-RACER	3630	345 x 245	+200 a reloj	3	(*)	(*)
CBR1000RR FIREBLADE/SP	20' - 21'	Z-RACING	20313	335 x 270		3	(*)	(*)
CBR1000RR FIREBLADE/SP	20' - 21'	R-RACER	20314	335 x 270	+70	3	(*)	(*)
CRF1000L AFRICA TWIN	16' - 19'	SPORT	8904	415 x 290	-50	4	(*)	(*)
CRF1000L AFRICA TWIN	16' - 19'	ADJUSTABLE	9155	415 x 290	+30	4	(*)	(*)
CRF1000L AFRICA TWIN	16' - 19'	TOURING	8905	590 x 355	+90	4	(*)	(*)

ANODIZED ALUMINIUM SCREWS AVAILABLE SEE PAGE 102.

R Red
 V Green
 W Transparent
 C Carbon look

T Orange
 A Blue
 H Smoke

G Yellow
 N Black
 F Dark Smoke

CARBON LOOK: RACING SCREEN AVAILABLE ONLY.
NOTE COLORS: N COLOR DELIVERED WITHOUT SILK PRINT.

(-) Adjustable in width and height.

(*) Check price with your distributor.

IMPORTANT: Indicate code color after part#. Example 0973A.

WINDSCREEN MODELS

HI-TECH PARTS | TYPE OF WINDSCREEN:

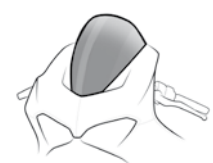

STANDARD

Windscreen without supports, form and height are the same as the original windscreen.



SPORT

Windscreen without supports, lower than the original windscreen.

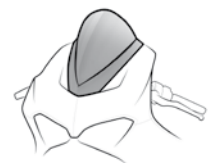

RACING

Doble height Windscreen, it drives the air away from your helmet, for supersport bikes.

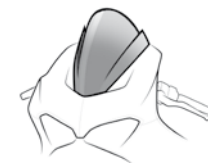

Z-RACING

Windscreen with edges in Z form that drives the air away from the helmet. Slightly taller than the original. Wide range of colors.



R-RACER

Windscreen that comes from competition, without edges. Significantly taller than the original one. Available in smoked colors.

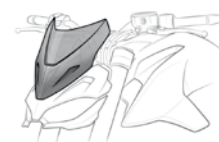

NG SPORT / TOURING

Windscreen with adaptor specifically designed for motorcycles that do not have a screen, especially for Naked models.



TOURING

Windscreen taller than the original to provide more protection to the rider.

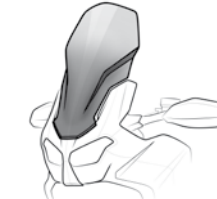

TOURING PLUS

Windscreen larger than the Puig Touring model, for certain models of motorcycle tourer for maximum aerodynamic protection.



TOURING WITH VISOR

Higher windscreen than the original that incorporates a multi-adjustable screwed visor to divert air from the rider and provide comfort.



TOURING WITH VISOR "CLIP ON"

Higher windscreen than the original to which is assigned a multi-adjustable visor that is fixed with a system called "clip-on" to divert the air from the rider and provide maximum comfort when driving.



ADJUSTABLE

Windscreen that can be adjusted in height, with or without tools and adjust it to the most suitable position for each rider / situation.

2022		For the new 2022 motorcycle models check www.puig.tv						
MODEL	YEAR	TYPE OF WINDSCREEN	REF.	DIMENSIONS (Height x Width)	HEIGHT (mm) Compared to OEM	THICKNESS (mm)	N W G R T F H A V C	
CRF1000L AFRICA TWIN	16' - 19'	TOURING SCREEN WITH VISOR BOLT-ON	8906H				(*)	
CRF1000L AFRICA TWIN	16' - 19'	TOURING SCREEN WITH CLIP-ON VISOR	8905 + 6319				(*)	
CRF1100L AFRICA TWIN	20' - 21'	TOURING	3818	480 x 320	+150 - +125	4	(*)	
CRF1100L AFRICA TWIN	20' - 21'	TOURING SCREEN WITH VISOR BOLT-ON	3819H				(*)	
CRF1100L AFRICA TWIN	20' - 21'	TOURING SCREEN WITH CLIP-ON VISOR	3818+6320				(*)	
CRF1000L AFRICA TWIN ADVENTURE SPORTS	18' - 19'	SPORT	8904	415 x 290	-50	4	(*) (*)	
CRF1000L AFRICA TWIN ADVENTURE SPORTS	18' - 19'	ADJUSTABLE	9155	415 x 290	+30	4	(*) (*)	
CRF1000L AFRICA TWIN ADVENTURE SPORTS	18' - 19'	TOURING	8905	590 x 355	+90	4	(*) (*)	
CRF1000L AFRICA TWIN ADVENTURE SPORTS	18' - 19'	TOURING SCREEN WITH VISOR BOLT-ON	8906H				(*)	
CRF1000L AFRICA TWIN ADVENTURE SPORTS	18' - 19'	TOURING SCREEN WITH CLIP-ON VISOR	8905 + 6319				(*)	
CRF1100L AFRICA TWIN ADVENTURE SPORTS	20' - 21'	SPORT	3820	450 x 295	-55	4	(*)	
CMX 300 REBEL	17' - 20'	NG SPORT / TOURING	SEE PAGE 130					
CMX 500 REBEL	17' - 21	NG SPORT / TOURING	SEE PAGE 130					
CMX 500 REBEL S	20' - 21'	NG SPORT / TOURING	SEE PAGE 130					
CMX 1100 REBEL	21'	NG SPORT / TOURING	SEE PAGE 131					
CROSSRUNNER	11' - 14'	TOURING	5639	480 x 470	+180	3	(*) (*)	
CROSSRUNNER	15' - 16'	TOURING	7626	570 x 435	+150	4	(*)	
CROSSRUNNER	15' - 16'	TOURING SCREEN WITH VISOR BOLT-ON	7627H				(*)	
CROSSRUNNER	15' - 16'	TOURING SCREEN WITH CLIP-ON VISOR	7626 + 6375				(*)	
CROSSTOURER	12' - 15'	TOURING	5993	510 x 470	+165	3	(*)	
CROSSTOURER	12' - 15'	TOURING SCREEN WITH VISOR BOLT-ON	6003H				(*)	

2022		For the new 2022 motorcycle models check www.puig.tv						
MODEL	YEAR	TYPE OF WINDSCREEN	REF.	DIMENSIONS (Height x Width)	HEIGHT (mm) Compared to OEM	THICKNESS (mm)	N W G R T F H A V C	
CROSSTOURER	12' - 15'	TOURING SCREEN WITH CLIP-ON VISOR	5993 + 6375				(*)	
CTX700	14' - 16'	TOURING	7227	510 x 580	+280	4	(*)	
CTX700N	14' - 16'	NG SPORT / TOURING	SEE PAGE 131					
CTX1300	14' - 16'	TOURING	7005	580 x 570	+325	4	(*)	
CTX1300	14' - 16'	TOURING SCREEN WITH VISOR BOLT-ON	7006H				(*)	
CTX1300	14' - 16'	TOURING SCREEN WITH CLIP-ON VISOR	7005 + 6375				(*)	
GL1800 GOLD WING	18' - 21'	TOURING	3160	730 x 685	+150	4	(*)	
NC700S	12' - 13'	TOURING	5991	340 x 295	+285	3	(*) (*)	
NC700S	12' - 13'	TOURING PLUS	6361	430 x 320	+285	3	(*) (*)	
NC700S	12' - 13'	TOURING PLUS SCREEN WITH VISOR BOLT-ON	6001H				(*)	
NC700S	12' - 13'	TOURING PLUS SCREEN WITH CLIP-ON VISOR	6361 + 6319				(*)	
NC750S	14' - 21'	TOURING	5991	340 x 295	+285	3	(*) (*)	
NC750S	14' - 21'	TOURING PLUS	6361	430 x 320	+285	3	(*) (*)	
NC750S	14' - 21'	TOURING PLUS SCREEN WITH VISOR BOLT-ON	6001H				(*)	
NC750S	14' - 21'	TOURING PLUS SCREEN WITH CLIP-ON VISOR	6361 + 6319				(*)	
NC700X	12' - 13'	TOURING	5992	480 x 420	+150	3	(*)	
NC700X	12' - 13'	TOURING SCREEN WITH VISOR BOLT-ON	6002H				(*)	

ANODIZED ALUMINIUM SCREWS AVAILABLE SEE PAGE 102.

R Red	V Green	W Transparent	C Carbon look
T Orange	A Blue	H Smoke	
G Yellow	N Black	F Dark Smoke	

CARBON LOOK: RACING SCREEN AVAILABLE ONLY. NOTE COLORS: N COLOR DELIVERED WITHOUT SILK PRINT.

(-) Adjustable in width and height. (*) Check price with your distributor. IMPORTANT: Indicate code color after part#. Example 0973A.

WINDSCREEN MODELS

HI-TECH PARTS | TYPE OF WINDSCREEN:



STANDARD

Windscreen without supports, form and height are the same as the original windscreen.



SPORT

Windscreen without supports, lower than the original windscreen.



RACING

Doble height Windscreen, it drives the air away from your helmet, for supersport bikes.



Z-RACING

Windscreen with edges in Z form that drives the air away from the helmet. Slightly taller than the original. Wide range of colors.



R-RACER

Windscreen that comes from competition, without edges. Significantly taller than the original one. Available in smoked colors.



NG SPORT / TOURING

Windscreen with adaptor specifically designed for motorcycles that do not have a screen, especially for Naked models.



TOURING

Windscreen taller than the original to provide more protection to the rider.



TOURING PLUS

Windscreen larger than the Puig Touring model, for certain models of motorcycle tourer for maximum aerodynamic protection.



TOURING WITH VISOR

Higher windscreen than the original that incorporates a multi-adjustable screwed visor to divert air from the rider and provide comfort.



TOURING WITH VISOR "CLIP ON"

Higher windscreen than the original to which is assigned a multi-adjustable visor that is fixed with a system called "clip-on" to divert the air from the rider and provide maximum comfort when driving.



ADJUSTABLE

Windscreen that can be adjusted in height, with or without tools and adjust it to the most suitable position for each rider / situation.

2022		For the new 2022 motorcycle models check www.puig.tv						
MODEL	YEAR	TYPE OF WINDSCREEN	REF.	DIMENSIONS (Height x Width)	HEIGHT (mm) Compared to OEM	THICKNESS (mm)	N W G R T F H A V C	
NC700X	12' - 13'	TOURING SCREEN WITH CLIP-ON VISOR	5992 + 6319				(*)	
NC750X	14' -15'	TOURING	5992	480 x 420	+150	3	(*)	
NC750X	14' -15'	TOURING SCREEN WITH VISOR BOLT-ON	6002H				(*)	
NC750X	14' -15'	TOURING SCREEN WITH CLIP-ON VISOR	5992 + 6319				(*)	
NC750X	16' - 20'	SPORT	8909	300 x 270	-110	3	(*)	
NC750X	16' - 20'	TOURING	8910	520 x 325	+115	3	(*) (*)	
NC750X	16' - 20'	TOURING SCREEN WITH VISOR BOLT-ON	8911H				(*)	
NC750X	16' - 20'	TOURING SCREEN WITH CLIP-ON VISOR	8910 + 6320				(*)	
NC750X	21'	TOURING	20752	540 x 330	+100		(*)	
NC750X	21'	TOURING SCREEN WITH VISOR BOLT-ON	20753H				(*)	
NC750X	21'	TOURING SCREEN WITH CLIP-ON VISOR	20752 + 6320				(*)	
NC750X	21'	SPORT	20773	380 x 295	-30	4	(*)	
NT650V DEAUVILLE	98' - 05'	TOURING	0414	550 x 380	+210	3	(*)	
PAN-EUROPEAN	02' - 13'	TOURING	5995	590 x 630	+70	4	(*) (*)	
PAN-EUROPEAN	02' - 13'	TOURING SCREEN WITH VISOR BOLT-ON	7591H				(*)	
PAN-EUROPEAN	02' - 13'	TOURING SCREEN WITH CLIP-ON VISOR	5995 + 6375				(*)	
VFR800	02' - 13'	RACING	1097	390 x 390		3	(*)	
VFR800F	14' - 18'	Z-RACING	7598	435 x 340	+30	3	(*) (*)	
VFR800F	14' - 18'	TOURING	7007	540 x 400	+130	3	(*)	
VFR800F	14' - 18'	TOURING SCREEN WITH VISOR BOLT-ON	7008H				(*)	

2022		For the new 2022 motorcycle models check www.puig.tv						
MODEL	YEAR	TYPE OF WINDSCREEN	REF.	DIMENSIONS (Height x Width)	HEIGHT (mm) Compared to OEM	THICKNESS (mm)	N W G R T F H A V C	
VFR800F	14' - 18'	TOURING SCREEN WITH CLIP-ON VISOR	7007 + 6320				(*)	
VFR1200F	10' - 16'	Z-RACING	5251	450X410	+30	3	(*) (*)	
X-ADV	17' - 20'	TOURING	9709	655 x 430	+115	4	(*)	
X-ADV	17' - 20'	TOURING SCREEN WITH VISOR BOLT-ON	9712H				(*)	
X-ADV	17' - 20'	TOURING SCREEN WITH CLIP-ON VISOR	9709 + 6320				(*)	
X-ADV	21'	SPORT	20584	570 x 365	-10	4	(*)	
X-ADV	21'	TOURING	20585	710 x 380	+105	4	(*)	
HUSQVARNA								
701 ENDURO	16' - 20'	NG SPORT / TOURING	SEE PAGE 131					
701 SUPERMOTO	15' - 20'	NG SPORT / TOURING	SEE PAGE 131					
NUDA 900/R	12' - 14'	NG SPORT / TOURING	SEE PAGE 131					
SVARTPILEN 401	17' - 21'	NG SPORT / TOURING	SEE PAGE 131					
SVARTPILEN 701	19' - 21'	NG SPORT / TOURING	SEE PAGE 131					
VITPILEN 401	17' - 21'	NG SPORT / TOURING	SEE PAGE 131					
VITPILEN 701	17' - 21'	NG SPORT / TOURING	SEE PAGE 131					
HYOSUNG								
GT125R	06' - 13'	RACING	4184	370 x 365		3	(*) (*)	
GT250Ri	06' -18'	RACING	4184	370 x 365		3	(*) (*)	
GT650R	05' - 17'	RACING	4184	370 x 365		3	(*) (*)	
GT650Ri	13' - 20'	Z-RACING	6716	385 x 355	+55	3	(*) (*)	
INDIAN								
FTR 1200/S	19' - 21'	NG SPORT / TOURING	SEE PAGE 131					

ANODIZED ALUMINIUM SCREWS AVAILABLE SEE PAGE 102.

R Red
 V Green
 W Transparent
 C Carbon look

T Orange
 A Blue
 H Smoke

G Yellow
 N Black
 F Dark Smoke

CARBON LOOK: RACING SCREEN AVAILABLE ONLY. NOTE COLORS: N COLOR DELIVERED WITHOUT SILK PRINT.

(-) Adjustable in width and height.

(*) Check price with your distributor.

IMPORTANT: Indicate code color after part#. Example 0973A.

WINDSCREEN MODELS

HI-TECH PARTS | TYPE OF WINDSCREEN:



STANDARD

Windscreen without supports, form and height are the same as the original windscreen.



SPORT

Windscreen without supports, lower than the original windscreen.



RACING

Doble height Windscen, it drives the air away from your helmet, for supersport bikes.

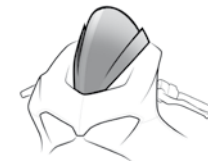

Z-RACING

Windscreen with edges in Z form that drives the air away from the helmet. Slightly taller than the original. Wide range of colors.



R-RACER

Windscreen that comes from competition, without edges. Significantly taller than the original one. Available in smoked colors.



NG SPORT / TOURING

Windscreen with adaptor specifically designed for motorcycles that do not have a screen, especially for Naked models.



TOURING

Windscreen taller than the original to provide more protection to the rider.



TOURING PLUS

Windscreen larger than the Puig Touring model, for certain models of motorcycle tourer for maximum aerodynamic protection.



TOURING WITH VISOR

Higher windscreen than the original that incorporates a multi-adjustable screwed visor to divert air from the rider and provide comfort.



TOURING WITH VISOR "CLIP ON"

Higher windscreen than the original to which is assigned a multi-adjustable visor that is fixed with a system called "clip-on" to divert the air from the rider and provide maximum comfort when driving.



ADJUSTABLE

Windscreen that can be adjusted in height, with or without tools and adjust it to the most suitable position for each rider / situation.

2022		For the new 2022 motorcycle models check www.puig.tv							
MODEL	YEAR	TYPE OF WINDSCREEN	REF.	DIMENSIONS (Height x Width)	HEIGHT (mm) Compared to OEM	THICKNESS (mm)	N W F H	G R T A V C	
KAWASAKI									
ER-6F	09' - 11'	TOURING	4931	460 x 330		3	(*)	(*)	
ER-6F	12' - 16'	TOURING	5998	540 x 450	+100	3	(*)	(*)	
ER-6F	12' - 16'	TOURING SCREEN WITH VISOR BOLT-ON	6004H				(*)		
ER-6F	12' - 16'	TOURING SCREEN WITH CLIP-ON VISOR	5998 + 6375				(*)		
ER-6N	05' - 08'	NG SPORT / TOURING	SEE PAGE 131						
ER-6N	09' - 11'	NG SPORT / TOURING	SEE PAGE 131						
ER-6N	12' - 16'	NG SPORT / TOURING	SEE PAGE 131						
GTR1400	07' - 09'	TOURING	4619	680 x 570	+195	4	(*)		
GTR1400	07' - 09'	TOURING SCREEN WITH VISOR BOLT-ON	5904H				(*)		
GTR1400	07' - 09'	TOURING SCREEN WITH CLIP-ON VISOR	4619 + 6375				(*)		
GTR1400	10' - 14'	TOURING	4619	680 x 570	+130	4	(*)		
GTR1400	10' - 14'	TOURING SCREEN WITH VISOR BOLT-ON	5904H				(*)		
GTR1400	10' - 14'	TOURING SCREEN WITH CLIP-ON VISOR	4619 + 6375				(*)		
GTR1400	15' - 17'	TOURING	7628	705 x 580	+105	4	(*)		
GTR1400	15' - 17'	TOURING SCREEN WITH VISOR BOLT-ON	7629H				(*)		
GTR1400	15' - 17'	TOURING SCREEN WITH CLIP-ON VISOR	7628 + 6375				(*)		
KLV1000	04' - 05'	TOURING	1880	515 x 415	+120	3	(*)	(*)	
NINJA 125	19' - 21'	Z-RACING	3539	295 x 285	+30	3	(*)	(*)	
NINJA 250R	08' - 12'	RACING	4626	340 x 325		3	(*)	(*)	
NINJA 250SL	15' - 16'	Z-RACING	7630	345 x 270	+65	3	(*)	(*)	
NINJA 300	13' - 17'	Z-RACING	6463	415 x 355	+40	3	(*)	(*)	

2022		For the new 2022 motorcycle models check www.puig.tv							
MODEL	YEAR	TYPE OF WINDSCREEN	REF.	DIMENSIONS (Height x Width)	HEIGHT (mm) Compared to OEM	THICKNESS (mm)	N W F H	G R T A V C	
NINJA 400	18' - 21'	Z-RACING	9976	400 x 335	+30	3	(*)	(*)	
NINJA 650	17' - 19'	Z-RACING	9711	450 x 310	+65	3	(*)		
NINJA 650	20' - 21'	R-RACER	3880	455 x 385	+20	3	(*)		
NINJA 650	20' - 21'	Z-RACING	3881	485 x 385	+20	3	(*)		
NINJA H2	15' - 21'	Z-RACING	7631	330 x 330	+30	3	(*)		
NINJA H2 SX	18' - 21'	Z-RACING	9704	400 x 390	+15	3	(*)	(*)	
NINJA 1000 SX	20' - 21'	RACING	20471	480 x 420		3	(*)	(*)	
VERSYS-X 300	17' - 20'	TOURING	9710	520 x 310	+115	3	(*)		
VERSYS-X 300	17' - 20'	TOURING SCREEN WITH VISOR BOLT-ON	9713H				(*)		
VERSYS-X 300	17' - 20'	TOURING SCREEN WITH CLIP-ON VISOR	9710 + 5852				(*)		
VERSYS 650	10' - 14'	TOURING	5255	400 x 315	+60	3	(*)		
VERSYS 650	10' - 14'	TOURING SCREEN WITH VISOR BOLT-ON	5905H				(*)		
VERSYS 650	10' - 14'	TOURING SCREEN WITH CLIP-ON VISOR	5255 + 6319				(*)		
VERSYS 650	15' - 16'	TOURING	9421	500 x 450	+130	3	(*)		
VERSYS 650	17' - 21'	TOURING	9421	500 x 450	+130	3	(*)		
VERSYS 1000	12' - 16'	TOURING	9421	500 x 450	+130	3	(*)		
VERSYS 1000	17' - 18'	TOURING	9421	500 x 450	+130	3	(*)		
VERSYS 1000	19' - 21'	TOURING	9421	500 x 450	+130	3	(*)		
VERSYS 1000 SE	19' - 20'	TOURING	3640	555 x 487	+70	4	(*)		
VERSYS 1000 SE	19' - 20'	TOURING SCREEN WITH VISOR BOLT-ON	3731H				(*)		

ANODIZED ALUMINIUM SCREWS AVAILABLE SEE PAGE 102.

R Red	V Green	W Transparent	C Carbon look
T Orange	A Blue	H Smoke	
G Yellow	N Black	F Dark Smoke	

CARBON LOOK: RACING SCREEN AVAILABLE ONLY.
NOTE COLORS: N COLOR DELIVERED WITHOUT SILK PRINT.

(-) Adjustable in width and height.

(*) Check price with your distributor.

IMPORTANT: Indicate code color after part#. Example 0973A.

WINDSCREEN MODELS

HI-TECH PARTS | TYPE OF WINDSCREEN:



STANDARD

Windscreen without supports, form and height are the same as the original windscreen.



SPORT

Windscreen without supports, lower than the original windscreen.



RACING

Doble height Windscreen, it drives the air away from your helmet, for supersport bikes.

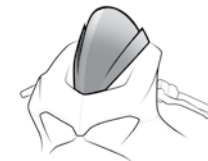

Z-RACING

Windscreen with edges in Z form that drives the air away from the helmet. Slightly taller than the original. Wide range of colors.



R-RACER

Windscreen that comes from competition, without edges. Significantly taller than the original one. Available in smoked colors.



NG SPORT / TOURING

Windscreen with adaptor specifically designed for motorcycles that do not have a screen, especially for Naked models.



TOURING

Windscreen taller than the original to provide more protection to the rider.



TOURING PLUS

Windscreen larger than the Puig Touring model, for certain models of motorcycle tourer for maximum aerodynamic protection.



TOURING WITH VISOR

Higher windscreen than the original that incorporates a multi-adjustable screwed visor to divert air from the rider and provide comfort.



TOURING WITH VISOR "CLIP ON"

Higher windscreen than the original to which is assigned a multi-adjustable visor that is fixed with a system called "clip-on" to divert the air from the rider and provide maximum comfort when driving.



ADJUSTABLE

Windscreen that can be adjusted in height, with or without tools and adjust it to the most suitable position for each rider / situation.

2022		For the new 2022 motorcycle models check www.puig.tv					
MODEL	YEAR	TYPE OF WINDSCREEN	REF.	DIMENSIONS (Height x Width)	HEIGHT (mm) Compared to OEM	THICKNESS (mm)	N W G R T F H A V C
VERSYS 1000 SE	19' - 20'	TOURING SCREEN WITH CLIP-ON VISOR	3640 +6375				(*)
VERSYS 1000 TOURER	19' - 20'	TOURING	3640	555 x 487	+70	4	(*)
VERSYS 1000 TOURER	19' - 20'	TOURING SCREEN WITH VISOR BOLT-ON	3731H				(*)
VERSYS 1000 TOURER	19' - 20'	TOURING SCREEN WITH CLIP-ON VISOR	3640 +6375				(*)
VERSYS 1000 GRAND TOURER	19' - 20'	TOURING	3640	555 x 487	+70	4	(*)
VERSYS 1000 GRAND TOURER	19' - 20'	TOURING SCREEN WITH VISOR BOLT-ON	3731H				(*)
VERSYS 1000 GRAND TOURER	19' - 20'	TOURING SCREEN WITH CLIP-ON VISOR	3640 +6375				(*)
VERSYS 1000 TOURER PLUS	19' - 20'	TOURING	3640	555 x 487	+70	4	(*)
VERSYS 1000 TOURER PLUS	19' - 20'	TOURING SCREEN WITH VISOR BOLT-ON	3731H				(*)
VERSYS 1000 TOURER PLUS	19' - 20'	TOURING SCREEN WITH CLIP-ON VISOR	3640 +6375				(*)
VULCAN S	15' - 21'	NG SPORT / TOURING	SEE PAGE 131				
VULCAN S CAFE	17' - 20'	NG SPORT / TOURING	SEE PAGE 131				
Z125	19' - 21'	NG SPORT / TOURING	SEE PAGE 131				
Z250SL	15' - 16'	NG SPORT / TOURING	SEE PAGE 131				
Z300	15' - 17'	NG SPORT / TOURING	SEE PAGE 131				
Z400	19' - 21'	NG SPORT / TOURING	SEE PAGE 131				
Z650	17' - 21'	NG SPORT / TOURING	SEE PAGE 131				
Z750S	05' - 06'	TOURING	2087	390 x 295		3	(*)
Z750	07' - 12'	NG SPORT / TOURING	SEE PAGE 131				
Z750R	11' - 12'	NG SPORT / TOURING	SEE PAGE 131				
Z800	13' - 16'	NG SPORT / TOURING	SEE PAGE 131				
Z800E	13' - 16'	NG SPORT / TOURING	SEE PAGE 131				
Z900	17' - 21'	NG SPORT / TOURING	SEE PAGE 131				

2022		For the new 2022 motorcycle models check www.puig.tv					
MODEL	YEAR	TYPE OF WINDSCREEN	REF.	DIMENSIONS (Height x Width)	HEIGHT (mm) Compared to OEM	THICKNESS (mm)	N W G R T F H A V C
Z1000	03' - 06'	STANDARD	1336				(*)
Z1000	10' - 13'	NG SPORT / TOURING	SEE PAGE 131				
Z1000	14' - 21'	NG SPORT / TOURING	SEE PAGE 131				
Z1000R	17' - 21'	NG SPORT / TOURING	SEE PAGE 132				
Z1000SX	11' - 16'	Z-RACING	9408	505 x 400	+53	3	(*)
Z1000SX	17' - 19'	Z-RACING	9408	470X380		3	(*)
Z H2	20' - 21'	NG SPORT / TOURING	SEE PAGE 132				
Z H2 SE	20' - 21'	NG SPORT / TOURING	SEE PAGE 132				
ZRX1200R	97' - 06'	TOURING	0426	365 x 325	+117	3	(*) (*)
ZRX1200S	01' - 07'	STANDARD	0059			3	(*)
ZX-6R	01' - 02'	Z-RACING	0514	430 x 385		3	(*)
ZX-6R	03' - 04'	Z-RACING	1335	340 x 430		3	(*)
ZX-6R	05' - 08'	Z-RACING	4053	400 x 360		3	(*) (*)
ZX-6R	09' - 16'	Z-RACING	6482	340 x 350	+25	3	(*)
ZX-6R 636	13' - 16'	Z-RACING	6482	340 x 350	+25	3	(*)
ZX-6R 636	13' - 16'	R-RACER	3629	370 x 350	+40	3	(*)
ZX-6R 636	19' - 21'	Z-RACING	3177	350 x 350	+15	3	(*) (*)
ZX-6R 636	19' - 21'	R-RACER	3629	350 x 350	+40	3	(*)
ZX-9R	94' - 97'	STANDARD	0344			3	(*)
ZX-9R	00' - 04'	RACING	0565	390 x 350		3	(*)
ZX-10R	04' - 05'	RACING	1657	380 x 300		3	(*)
ZX-10R	06' - 07'	STANDARD	4052	360 x 360		3	(*)
ZX-10R	06' - 07'	RACING	4053	400 x 360		3	(*) (*)
ZX-10R	08' - 10'	Z-RACING	6482	340 x 350	+25	3	(*)
ZX-10R	11' - 15'	STANDARD	5602	410 x 390		3	(*)

ANODIZED ALUMINIUM SCREWS AVAILABLE SEE PAGE 102.

■ R Red ■ V Green ■ W Transparent ■ C Carbon look
■ T Orange ■ A Blue ■ H Smoke
■ G Yellow ■ N Black ■ F Dark Smoke

CARBON LOOK: RACING SCREEN AVAILABLE ONLY.
NOTE COLORS: N COLOR DELIVERED WITHOUT SILK PRINT.

(-) Adjustable in width and height.

(*) Check price with your distributor.

IMPORTANT: Indicate code color after part#. Example 0973A.

WINDSCREEN MODELS

HI-TECH PARTS | TYPE OF WINDSCREEN:



STANDARD

Windscreen without supports, form and height are the same as the original windscreen.



SPORT

Windscreen without supports, lower than the original windscreen.



RACING

Doble height Windscreen, it drives the air away from your helmet, for supersport bikes.

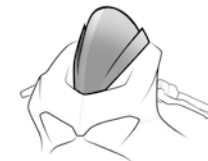

Z-RACING

Windscreen with edges in Z form that drives the air away from the helmet. Slightly taller than the original. Wide range of colors.



R-RACER

Windscreen that comes from competition, without edges. Significantly taller than the original one. Available in smoked colors.



NG SPORT / TOURING

Windscreen with adaptor specifically designed for motorcycles that do not have a screen, especially for Naked models.



TOURING

Windscreen taller than the original to provide more protection to the rider.

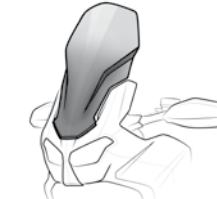

TOURING PLUS

Windscreen larger than the Puig Touring model, for certain models of motorcycle tourer for maximum aerodynamic protection.



TOURING WITH VISOR

Higher windscreen than the original that incorporates a multi-adjustable screwed visor to divert air from the rider and provide comfort.



TOURING WITH VISOR "CLIP ON"

Higher windscreen than the original to which is assigned a multi-adjustable visor that is fixed with a system called "clip-on" to divert the air from the rider and provide maximum comfort when driving.



ADJUSTABLE

Windscreen that can be adjusted in height, with or without tools and adjust it to the most suitable position for each rider / situation.

2022		For the new 2022 motorcycle models check www.puig.tv							
MODEL	YEAR	TYPE OF WINDSCREEN	REF.	DIMENSIONS (Height x Width)	HEIGHT (mm) Compared to OEM	THICKNESS (mm)	N W F H	G R T A V C	
ZX-10R	11' - 15'	Z-RACING	5603	410 x 365		3	(*)	(*)	
ZX-10R	16' - 20'	Z-RACING	8912	350 x 300	+40	3	(*)	(*)	
ZX-10R	16' - 20'	R-RACER	9849	360 x 325	+10	3	(*)		
ZX-10R	21'	Z-RACING	20541	320 x 285	+35	3	(*)		
ZX-10R	21'	R-RACER	20540	320 x 285	+60	3	(*)		
ZX-10RR	17' - 20'	Z-RACING	8912	350 x 300	+40	3	(*)	(*)	
ZX-10RR	17' - 20'	R-RACER	9849	360 x 325	+10	3	(*)		
ZX-10RR	21'	Z-RACING	20541	320 x 285	+35	3	(*)		
ZX-10RR	21'	R-RACER	20540	320 x 285	+60	3	(*)		
ZX-10R SE	18' - 20'	Z-RACING	8912	350 x 300	+40	3	(*)	(*)	
ZX-10R SE	18' - 20'	R-RACER	9849	360 x 325	+10	3	(*)		
ZX-10R KRT REPLICAS	18' - 20'	Z-RACING	8912	350 x 300	+40	3	(*)	(*)	
ZX-10R KRT REPLICAS	18' - 20'	R-RACER	9849	360 x 325	+10	3	(*)		
ZX-12R	00' - 01'	TOURING	0422	480 x 375	+78	3	(*)	(*)	
ZX-12R	02' - 06'	STANDARD	1121	390 x 380		3	(*)	(*)	
ZZR600	93' - 06'	TOURING	0207	420 x 380	+39		(*)		
ZZR1400	06' - 21'	STANDARD	4056	390 x 375		3	(*)		
ZZR1400	06' - 21'	RACING	4057	440 x 360	+25	3	(*)	(*)	
KTM									
125 DUKE	11' - 21'	NG SPORT / TOURING	SEE PAGE 132						
200 DUKE	12 - 15'	NG SPORT / TOURING	SEE PAGE 132						
250 ADVENTURE	21'	TOURING	20414	500 x 330	+200		(*)		
250 ADVENTURE	21'	TOURING SCREEN WITH VISOR BOLT-ON	20415H				(*)		
250 ADVENTURE	21'	TOURING SCREEN WITH CLIP-ON VISOR	20414+6320				(*)		
390 DUKE	13' - 21'	NG SPORT / TOURING	SEE PAGE 132						
390 ADVENTURE	20' - 21'	TOURING	20414	500 x 330	+200		(*)		
390 ADVENTURE	20' - 21'	TOURING SCREEN WITH VISOR BOLT-ON	20415H				(*)		

2022		For the new 2022 motorcycle models check www.puig.tv							
MODEL	YEAR	TYPE OF WINDSCREEN	REF.	DIMENSIONS (Height x Width)	HEIGHT (mm) Compared to OEM	THICKNESS (mm)	N W F H	G R T A V C	
390 ADVENTURE	20' - 21'	TOURING SCREEN WITH CLIP-ON VISOR	20414+6320				(*)		
690 DUKE	08' - 11'	NG SPORT / TOURING	SEE PAGE 132						
690 DUKE	12' - 20'	NG SPORT / TOURING	SEE PAGE 132						
690 DUKE R	10' - 11'	NG SPORT / TOURING	SEE PAGE 132						
690 DUKE R	13' - 17'	NG SPORT / TOURING	SEE PAGE 132						
690 ENDURO R	19' - 21'	NG SPORT / TOURING	SEE PAGE 132						
690 SMC R	19' - 21'	NG SPORT / TOURING	SEE PAGE 132						
790 DUKE	18' - 21'	NG SPORT / TOURING	SEE PAGE 132						
790 ADVENTURE/R	19' - 21'	SPORT	3738	366 x 348	-70	4	(*)		
790 ADVENTURE/R	19' - 21'	TOURING	3587	525 x 385	+110	4	(*)		
790 ADVENTURE/R	19' - 21'	TOURING SCREEN WITH VISOR BOLT-ON	3588H				(*)		
790 ADVENTURE/R	19' - 21'	TOURING SCREEN WITH CLIP-ON VISOR	3587+6375				(*)		
790 ADVENTURE R RALLY	20' - 21'	SPORT	3738	366 x 348	-70	4	(*)		
790 ADVENTURE R RALLY	20' - 21'	TOURING	3587	525 x 385	+110	4	(*)		
790 ADVENTURE R RALLY	20' - 21'	TOURING SCREEN WITH VISOR BOLT-ON	3588H				(*)		
790 ADVENTURE R RALLY	20' - 21'	TOURING SCREEN WITH CLIP-ON VISOR	3587+6375				(*)		
890 ADVENTURE	21'	SPORT	3738	366 x 348	-70	4	(*)		
890 ADVENTURE	21'	TOURING	3587	525 x 385	+110	4	(*)		
890 ADVENTURE	21'	TOURING SCREEN WITH VISOR BOLT-ON	3588H				(*)		

ANODIZED ALUMINIUM SCREWS AVAILABLE SEE PAGE 102.

R Red	V Green	W Transparent	C Carbon look
T Orange	A Blue	H Smoke	
G Yellow	N Black	F Dark Smoke	

CARBON LOOK: RACING SCREEN AVAILABLE ONLY.
NOTE COLORS: N COLOR DELIVERED WITHOUT SILK PRINT.

(-) Adjustable in width and height.
(*) Check price with your distributor.
IMPORTANT: Indicate code color after part#. Example 0973A.

WINDSCREEN MODELS

HI-TECH PARTS | TYPE OF WINDSCREEN:



STANDARD

Windscreen without supports, form and height are the same as the original windscreen.



SPORT

Windscreen without supports, lower than the original windscreen.



RACING

Doble height Windscreen, it drives the air away from your helmet, for supersport bikes.



Z-RACING

Windscreen with edges in Z form that drives the air away from the helmet. Slightly taller than the original. Wide range of colors.



R-RACER

Windscreen that comes from competition, without edges. Significantly taller than the original one. Available in smoked colors.



NG SPORT / TOURING

Windscreen with adaptor specifically designed for motorcycles that do not have a screen, especially for Naked models.



TOURING

Windscreen taller than the original to provide more protection to the rider.



TOURING PLUS

Windscreen larger than the Puig Touring model, for certain models of motorcycle tourer for maximum aerodynamic protection.



TOURING WITH VISOR

Higher windscreen than the original that incorporates a multi-adjustable screwed visor to divert air from the rider and provide comfort.



TOURING WITH VISOR "CLIP ON"

Higher windscreen than the original to which is assigned a multi-adjustable visor that is fixed with a system called "clip-on" to divert the air from the rider and provide maximum comfort when driving.



ADJUSTABLE

Windscreen that can be adjusted in height, with or without tools and adjust it to the most suitable position for each rider / situation.

2022		For the new 2022 motorcycle models check www.puig.tv						
MODEL	YEAR	TYPE OF WINDSCREEN	REF.	DIMENSIONS (Height x Width)	HEIGHT (mm) Compared to OEM	THICKNESS (mm)	N W G R T F H A V C	
890 ADVENTURE	21'	TOURING SCREEN WITH CLIP-ON VISOR	3587+6375				(*)	
890 ADVENTURE R	21'	SPORT	3738	366 x 348	-70	4	(*)	
890 ADVENTURE R	21'	TOURING	3587	525 x 385	+110	4	(*)	
890 ADVENTURE R	21'	TOURING SCREEN WITH VISOR BOLT-ON	3588H				(*)	
890 ADVENTURE R RALLY	21'	SPORT	3738	366 x 348	-70	4	(*)	
890 ADVENTURE R RALLY	21'	TOURING	3587	525 x 385	+110	4	(*)	
890 ADVENTURE R RALLY	21'	TOURING SCREEN WITH VISOR BOLT-ON	3588H				(*)	
950 SUPERMOTO	05' - 07'	NG SPORT / TOURING	SEE PAGE 132					
950 SUPERMOTO R	07' - 08'	NG SPORT / TOURING	SEE PAGE 132					
950 SUPERENDURO	06' - 09'	NG SPORT / TOURING	SEE PAGE 132					
990 SUPERDUKE/R	07' - 13'	NG SPORT / TOURING	SEE PAGE 132					
990 SUPERMOTO	08' - 13'	NG SPORT / TOURING	SEE PAGE 132					
990 SUPERMOTO R	09' - 13'	NG SPORT / TOURING	SEE PAGE 132					
990 SUPERMOTO T	09' - 12'	TOURING	6495	510 x 400	+170	4	(*) (*)	
1050 ADVENTURE	15' - 16'	SPORT	6847	320 x 330	-125	3	(*)	
1050 ADVENTURE	15' - 16'	TOURING	6494	510 x 410	+50	3	(*) (*)	
1090 ADVENTURE/R	17' - 20'	SPORT	6847	320 x 330	-125	3	(*)	
1090 ADVENTURE/R	17' - 20'	TOURING	6494	510 x 410	+50	3	(*) (*)	
1190 ADVENTURE/R	13' - 16'	SPORT	6847	320 x 330	-125	3	(*)	
1190 ADVENTURE/R	13' - 16'	TOURING	6494	510 x 410	+50	3	(*) (*)	
1190 RC8/R	08' - 15'	Z-RACING	4944	370 x 350	+50	3	(*)	
1290 SUPERDUKE R	14' - 21'	NG SPORT / TOURING	SEE PAGE 132					
1290 SUPERDUKE GT	16' - 18'	TOURING	8913	600 x 440	+135	4	(*) (*)	
1290 SUPERDUKE GT	16' - 18'	TOURING SCREEN WITH VISOR BOLT-ON	8914H				(*)	
1290 SUPERDUKE GT	16' - 18'	TOURING SCREEN WITH CLIP-ON VISOR	8913 + 6320				(*)	

2022		For the new 2022 motorcycle models check www.puig.tv						
MODEL	YEAR	TYPE OF WINDSCREEN	REF.	DIMENSIONS (Height x Width)	HEIGHT (mm) Compared to OEM	THICKNESS (mm)	N W G R T F H A V C	
1290 SUPERDUKE GT	19' - 21'	TOURING	3564	540 x 420	+115 - + 165	4	(*)	
1290 SUPERDUKE GT	19' - 21'	TOURING SCREEN WITH VISOR BOLT-ON	3565H				(*)	
1290 SUPERDUKE GT	19' - 21'	TOURING SCREEN WITH CLIP-ON VISOR	3564 + 6375				(*)	
1290 SUPER ADVENTURE	15' - 16'	SPORT	6847	320 x 330	-125	3	(*)	
1290 SUPER ADVENTURE	15' - 16'	TOURING	6494	510 x 410	+50	3	(*) (*)	
1290 SUPER ADVENTURE T	17'	SPORT	6847	320 x 330	-125	3	(*)	
1290 SUPER ADVENTURE T	17'	TOURING	6494	510 x 410	+50	3	(*) (*)	
1290 SUPER ADVENTURE R	17' - 20'	SPORT	9716	290 x 310	-105	4	(*)	
1290 SUPER ADVENTURE R	17' - 20'	TOURING	9717	490 x 420	+75	4	(*)	
1290 SUPER ADVENTURE R	17' - 20'	TOURING SCREEN WITH VISOR BOLT-ON	9714H				(*)	
1290 SUPER ADVENTURE R	17' - 20'	TOURING SCREEN WITH CLIP-ON VISOR	9717 + 6375				(*)	
1290 SUPER ADVENTURE S	17' - 20'	SPORT	9716	290 x 310	-105	4	(*)	
1290 SUPER ADVENTURE S	17' - 20'	TOURING	9717	490 x 420	+75	4	(*)	
1290 SUPER ADVENTURE S	17' - 20'	TOURING SCREEN WITH VISOR BOLT-ON	9714H				(*)	
1290 SUPER ADVENTURE S	17' - 20'	TOURING SCREEN WITH CLIP-ON VISOR	9717 + 6375				(*)	
1290 SUPER ADVENTURE R/S	21'	SPORT	20401	270 x 415	-55	4	(*)	
1290 SUPER ADVENTURE R/S	21'	TOURING	20422	440 x 465	+55	4	(*)	
1290 SUPER ADVENTURE R/S	21'	TOURING SCREEN WITH VISOR BOLT-ON	20586H				(*)	

ANODIZED ALUMINIUM SCREWS AVAILABLE SEE PAGE 102.

R Red	V Green	W Transparent	C Carbon look
T Orange	A Blue	H Smoke	
G Yellow	N Black	F Dark Smoke	

CARBON LOOK: RACING SCREEN AVAILABLE ONLY.
NOTE COLORS: N COLOR DELIVERED WITHOUT SILK PRINT.

(-) Adjustable in width and height.
(*) Check price with your distributor.
IMPORTANT: Indicate code color after part#. Example 0973A.

WINDSCREEN MODELS

HI-TECH PARTS | TYPE OF WINDSCREEN:



STANDARD
Windscreen without supports, form and height are the same as the original windscreen.



SPORT
Windscreen without supports, lower than the original windscreen.



RACING
Doble height Windscreen, it drives the air away from your helmet, for supersport bikes.



Z-RACING
Windscreen with edges in Z form that drives the air away from the helmet. Slightly taller than the original. Wide range of colors.



R-RACER
Windscreen that comes from competition, without edges. Significantly taller than the original one. Available in smoked colors.



NG SPORT / TOURING
Windscreen with adaptor specifically designed for motorcycles that do not have a screen, especially for Naked models.



TOURING
Windscreen taller than the original to provide more protection to the rider.

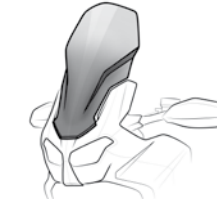

TOURING PLUS
Windscreen larger than the Puig Touring model, for certain models of motorcycle tourer for maximum aerodynamic protection.



TOURING WITH VISOR
Higher windscreen than the original that incorporates a multi-adjustable screwed visor to divert air from the rider and provide comfort.



TOURING WITH VISOR "CLIP ON"
Higher windscreen than the original to which is assigned a multi-adjustable visor that is fixed with a system called "clip-on" to divert the air from the rider and provide maximum comfort when driving.

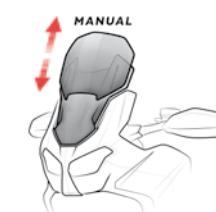

ADJUSTABLE
Windscreen that can be adjusted in height, with or without tools and adjust it to the most suitable position for each rider / situation.

2022		For the new 2022 motorcycle models check www.puig.tv							
MODEL	YEAR	TYPE OF WINDSCREEN	REF.	DIMENSIONS (Height x Width)	HEIGHT (mm) Compared to OEM	THICKNESS (mm)	N W G R T F H A V C		
1290 SUPER ADVENTURE R/S	21'	TOURING SCREEN WITH CLIP-ON VISOR	20422 + 20763				(*)		
1290 SUPER ADVENTURE R/S	21'	TOURING PLUS	20816	515 x 465	+130	4	(*)		
1290 SUPER ADVENTURE R/S	21'	TOURING PLUS SCREEN WITH VISOR BOLT-ON	20817H				(*)		
1290 SUPER ADVENTURE R/S	21'	TOURING PLUS SCREEN WITH CLIP-ON VISOR	20816 + 20763				(*)		
RC125/RC390	14' - 21'	Z-RACING	7004	410 x 320	+100	3	(*)		
MV AGUSTA									
BRUTALE 1000RR	20' - 21'	NG SPORT / TOURING	SEE PAGE 133						
F3 675	12' - 21'	Z-RACING	5651	330 x 325	+40	3	(*)		
F3 800	13' - 21'	Z-RACING	5651	330 x 325	+40	3	(*)	(*)	
F4	10' - 20'	Z-RACING	5256	410 x 370		3	(*)		
F4 1000 RR	13' - 20'	Z-RACING	5256	410 x 370		3	(*)		
RIVALE 800	13' - 18'	NG SPORT / TOURING	SEE PAGE 133						
STRADALE 800	15' - 16'	TOURING	7634	485 x 365	+120	3	(*)		
STRADALE 800	15' - 16'	TOURING SCREEN WITH CLIP-ON VISOR	7634 + 6320				(*)		
TURISMO VELOCE 800/LUSSO	14' - 21'	TOURING	7017	485 x 290	+100	3	(*)		
TURISMO VELOCE 800/LUSSO	14' - 21'	TOURING SCREEN WITH VISOR BOLT-ON	7018H				(*)		
TURISMO VELOCE 800/LUSSO	14' - 21'	TOURING SCREEN WITH CLIP-ON VISOR	7017 + 6319				(*)		
SUZUKI									
B-KING	08' - 11'	NG SPORT / TOURING	SEE PAGE 133						
DL250 V-STROM	17' - 21'	TOURING	9606	440 x 435	+95	4	(*)		
DL250 V-STROM	17' - 21'	TOURING SCREEN WITH VISOR BOLT-ON	9607H				(*)		
DL250 V-STROM	17' - 21'	TOURING SCREEN WITH CLIP-ON VISOR	9606 + 6320				(*)		

2022		For the new 2022 motorcycle models check www.puig.tv							
MODEL	YEAR	TYPE OF WINDSCREEN	REF.	DIMENSIONS (Height x Width)	HEIGHT (mm) Compared to OEM	THICKNESS (mm)	N W G R T F H A V C		
DL650 V-STROM	04' - 11'	TOURING	1880	512 x 420	+120	3	(*)	(*)	
DL650 V-STROM	04' - 11'	TOURING SCREEN WITH VISOR BOLT-ON	5883H				(*)		
DL650 V-STROM	04' - 11'	TOURING SCREEN WITH CLIP-ON VISOR	1880 + 6375				(*)		
DL650 V-STROM	12' - 16'	TOURING	5895	540 x 430	+120	3	(*)	(*)	
DL650 V-STROM	12' - 16'	TOURING SCREEN WITH VISOR BOLT-ON	6253H				(*)		
DL650 V-STROM	12' - 16'	TOURING SCREEN WITH CLIP-ON VISOR	5895 + 6320				(*)		
DL650 V-STROM	17' - 21'	TOURING	9719	440 x 445	+120	4	(*)		
DL650 V-STROM	17' - 21'	TOURING SCREEN WITH VISOR BOLT-ON	9440H				(*)		
DL650 V-STROM	17' - 21'	TOURING SCREEN WITH CLIP-ON VISOR	9719 + 6320				(*)		
DL650XT V-STROM	15' -16'	TOURING	5895	540 x 430	+120	3	(*)	(*)	
DL650XT V-STROM	15' -16'	TOURING SCREEN WITH VISOR BOLT-ON	6253H				(*)		
DL650XT V-STROM	15' -16'	TOURING SCREEN WITH CLIP-ON VISOR	5895 + 6320				(*)		
DL650XT V-STROM	17' - 21'	TOURING	9719	440 x 445	+120	4	(*)		
DL650XT V-STROM	17' - 21'	TOURING SCREEN WITH VISOR BOLT-ON	9440H				(*)		
DL650XT V-STROM	17' - 21'	TOURING SCREEN WITH CLIP-ON VISOR	9719 + 6320				(*)		

ANODIZED ALUMINIUM SCREWS AVAILABLE SEE PAGE 102.

R Red	V Green	W Transparent	C Carbon look
T Orange	A Blue	H Smoke	
G Yellow	N Black	F Dark Smoke	

CARBON LOOK: RACING SCREEN AVAILABLE ONLY.
NOTE COLORS: N COLOR DELIVERED WITHOUT SILK PRINT.

(-) Adjustable in width and height.

(*) Check price with your distributor.

IMPORTANT: Indicate code color after part#. Example 0973A.

WINDSCREEN MODELS

HI-TECH PARTS | TYPE OF WINDSCREEN:



STANDARD

Windscreen without supports, form and height are the same as the original windscreen.



SPORT

Windscreen without supports, lower than the original windscreen.



RACING

Doble height Windscreen, it drives the air away from your helmet, for supersport bikes.



Z-RACING

Windscreen with edges in Z form that drives the air away from the helmet. Slightly taller than the original. Wide range of colors.



R-RACER

Windscreen that comes from competition, without edges. Significantly taller than the original one. Available in smoked colors.



NG SPORT / TOURING

Windscreen with adaptor specifically designed for motorcycles that do not have a screen, especially for Naked models.



TOURING

Windscreen taller than the original to provide more protection to the rider.



TOURING PLUS

Windscreen larger than the Puig Touring model, for certain models of motorcycle tourer for maximum aerodynamic protection.



TOURING WITH VISOR

Higher windscreen than the original that incorporates a multi-adjustable screwed visor to divert air from the rider and provide comfort.



TOURING WITH VISOR "CLIP ON"

Higher windscreen than the original to which is assigned a multi-adjustable visor that is fixed with a system called "clip-on" to divert the air from the rider and provide maximum comfort when driving.



ADJUSTABLE

Windscreen that can be adjusted in height, with or without tools and adjust it to the most suitable position for each rider / situation.

2022		For the new 2022 motorcycle models check www.puig.tv						
MODEL	YEAR	TYPE OF WINDSCREEN	REF.	DIMENSIONS (Height x Width)	HEIGHT (mm) Compared to OEM	THICKNESS (mm)	N W G R T F H A V C	
DL1000 V-STROM	02' - 07'	TOURING	1880	515 x 420	+120	3	(*) (*)	
DL1000 V-STROM	14' - 19'	TOURING	7229	460 x 435	+165	4	(*) (*)	
DL1000 V-STROM	14' - 19'	TOURING SCREEN WITH VISOR BOLT-ON	7230H				(*) (*)	
DL1000 V-STROM	14' - 19'	TOURING SCREEN WITH CLIP-ON VISOR	7229 + 6320				(*) (*)	
DL1000XT V-STROM	17' - 19'	TOURING	7229	460 x 435	+165	4	(*) (*)	
DL1000XT V-STROM	17' - 19'	TOURING SCREEN WITH VISOR BOLT-ON	7230H				(*) (*)	
DL1000XT V-STROM	17' - 19'	TOURING SCREEN WITH CLIP-ON VISOR	7229 + 6320				(*) (*)	
DL1050 V-STROM	20' - 21'	TOURING	20411	630 x 480	+95	4	(*) (*)	
DL1050 V-STROM	20' - 21'	TOURING SCREEN WITH VISOR BOLT-ON	20412H				(*) (*)	
DL1050 V-STROM	20' - 21'	TOURING SCREEN WITH CLIP-ON VISOR	20411 + 6320				(*) (*)	
DL1050XT V-STROM	20' - 21'	TOURING	20411	630 x 480	+95	4	(*) (*)	
DL1050XT V-STROM	20' - 21'	TOURING SCREEN WITH VISOR BOLT-ON	20412H				(*) (*)	
DL1050XT V-STROM	20' - 21'	TOURING SCREEN WITH CLIP-ON VISOR	20411 + 6320				(*) (*)	
GSF600S BANDIT	00' - 04'	STANDARD	0697			3	(*) (*)	
GSF650 BANDIT	09' - 11'	NG SPORT / TOURING	SEE PAGE 133					
GSF650S BANDIT	05' - 08'	RACING	2107	340 x 360		3	(*) (*)	
GSF650S BANDIT	05' - 08'	TOURING	2125	410 x 360	+80	3	(*) (*)	
GSF1200S BANDIT	01' - 05'	STANDARD	0697			3	(*) (*)	
GSF1200S BANDIT	06'	RACING	2107	340 x 360		3	(*) (*)	
GSF1200S BANDIT	06'	TOURING	2125	410 x 355	+80	3	(*) (*)	
GSF1250 BANDIT	10' - 13'	NG SPORT / TOURING	SEE PAGE 133					
GSF1250S BANDIT	07' - 16'	RACING	2107	340 x 360		3	(*) (*)	

2022		For the new 2022 motorcycle models check www.puig.tv						
MODEL	YEAR	TYPE OF WINDSCREEN	REF.	DIMENSIONS (Height x Width)	HEIGHT (mm) Compared to OEM	THICKNESS (mm)	N W G R T F H A V C	
GSF1250S BANDIT	07' - 16'	TOURING	2125	410 x 355	+80	3	(*) (*)	
GSR600	06' - 11'	NG SPORT / TOURING	SEE PAGE 133					
GSR750	11' - 16'	NG SPORT / TOURING	SEE PAGE 133					
G SX650F	08' - 16'	RACING	4665	340 x 400		3	(*) (*)	
G SX650F	08' - 16'	TOURING	4633	450 x 395	+110	3	(*) (*)	
G SX1250F	10' - 17'	RACING	4665	340 x 400		3	(*) (*)	
G SX1250F	10' - 17'	TOURING	4633	450 x 395	+110	3	(*) (*)	
G SX-R125	17' - 21'	Z-RACING	9721	340 x 305	+10	3	(*) (*)	
G SX-R250	17' - 21'	Z-RACING	9722	365 x 300	+45	3	(*) (*)	
G SX-R600	98' - 00'	RACING	0950	430 x 395		3	(*) (*)	
G SX-R600	98' - 00'	TOURING	0798	450 x 415	+50	3	(*) (*)	
G SX-R600	01' - 03'	RACING	0189	400 x 430		3	(*) (*)	
G SX-R750	98' - 99'	RACING	0950	430 x 395		3	(*) (*)	
G SX-R750	98' - 99'	TOURING	0798	450 x 415	+50	3	(*) (*)	
G SX-R750	00' - 03'	RACING	0189	400 x 430		3	(*) (*)	
G SX-R600/750	04' - 05'	STANDARD	1654	350 x 330		3	(*) (*)	
G SX-R600/750	04' - 05'	RACING	1655	350 x 320		3	(*) (*)	
G SX-R600/750	06' - 07'	RACING	4055	355 x 320		3	(*) (*)	
G SX-R600/750	08' - 10'	Z-RACING	4629	350 x 325		3	(*) (*)	
G SX-R600/750	11' - 16'	Z-RACING	5605	280 x 300		3	(*) (*)	
G SX-R1000	01' - 02'	RACING	0189	400 x 430		3	(*) (*)	
G SX-R1000	03' - 04'	STANDARD	1338			3	(*) (*)	
G SX-R1000	03' - 04'	RACING	1340	400 x 470		3	(*) (*)	
G SX-R1000	05' - 06'	STANDARD	2071	320 x 320		3	(*) (*)	
G SX-R1000	05' - 06'	RACING	2072	310 x 300		3	(*) (*)	

ANODIZED ALUMINIUM SCREWS AVAILABLE SEE PAGE 102.

■ R Red ■ V Green ■ W Transparent ■ C Carbon look
■ T Orange ■ A Blue ■ H Smoke
■ G Yellow ■ N Black ■ F Dark Smoke

CARBON LOOK: RACING SCREEN AVAILABLE ONLY.
NOTE COLORS: N COLOR DELIVERED WITHOUT SILK PRINT.

(-) Adjustable in width and height.

(*) Check price with your distributor.

IMPORTANT: Indicate code color after part#. Example 0973A.

WINDSCREEN MODELS

HI-TECH PARTS | TYPE OF WINDSCREEN:

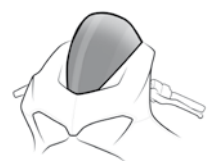

STANDARD

Windscreen without supports, form and height are the same as the original windscreen.



SPORT

Windscreen without supports, lower than the original windscreen.



RACING

Doble height Windscreen, it drives the air away from your helmet, for supersport bikes.



Z-RACING

Windscreen with edges in Z form that drives the air away from the helmet. Slightly taller than the original. Wide range of colors.



R-RACER

Windscreen that comes from competition, without edges. Significantly taller than the original one. Available in smoked colors.



NG SPORT / TOURING

Windscreen with adaptor specifically designed for motorcycles that do not have a screen, especially for Naked models.



TOURING

Windscreen taller than the original to provide more protection to the rider.

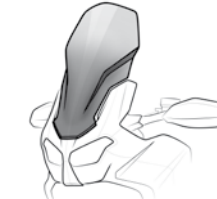

TOURING PLUS

Windscreen larger than the Puig Touring model, for certain models of motorcycle tourer for maximum aerodynamic protection.



TOURING WITH VISOR

Higher windscreen than the original that incorporates a multi-adjustable screwed visor to divert air from the rider and provide comfort.



TOURING WITH VISOR "CLIP ON"

Higher windscreen than the original to which is assigned a multi-adjustable visor that is fixed with a system called "clip-on" to divert the air from the rider and provide maximum comfort when driving.



ADJUSTABLE

Windscreen that can be adjusted in height, with or without tools and adjust it to the most suitable position for each rider / situation.

2022		For the new 2022 motorcycle models check www.puig.tv						
MODEL	YEAR	TYPE OF WINDSCREEN	REF.	DIMENSIONS (Height x Width)	HEIGHT (mm) Compared to OEM	THICKNESS (mm)	N W F H	G R T A V C
GSX-R1000	07' - 08'	STANDARD	4362			3	(*)	(*)
GSX-R1000	07' - 08'	RACING	4363	320 x 330		3	(*)	(*)
GSX-R1000	09' - 15'	STANDARD	4932	370 x 330		3	(*)	
GSX-R1000	09' - 16'	Z-RACING	4933	360 x 340		3	(*)	(*)
GSX-R1000/R	17' - 21'	Z-RACING	9013	310 x 280		3	(*)	(*)
GSX-R1000/R	17' - 21'	R-RACER	3631	288 x 285	+60	3	(*)	
GSX-R1300 HAYABUSA	99' - 07'	RACING	0953	370 x 450		3	(*)	(*)
GSX-R1300 HAYABUSA	08' - 20'	STANDARD	4825	400 x 440		3	(*)	
GSX-R1300 HAYABUSA	08' - 20'	RACING	4826	390 x 440		3	(*)	(*)
GSX-S125	17' - 21'	NG SPORT / TOURING	SEE PAGE 133					
GSX-S750	17' - 21'	NG SPORT / TOURING	SEE PAGE 133					
GSX-S1000	15' - 22'	NG SPORT / TOURING	SEE PAGE 133					
GSX-S1000F	15' - 21'	SPORT	7639	330 x 280	-160	3	(*)	(*)
GSX-S1000F	15' - 21'	TOURING	7640	590 x 325	+135	3	(*)	
GSX-S1000F	15' - 21'	TOURING SCREEN WITH VISOR BOLT-ON	7641H				(*)	
GSX-S1000F	15' - 21'	TOURING SCREEN WITH CLIP-ON VISOR	7640 + 6320				(*)	
INAZUMA	13' - 17'	NG SPORT / TOURING	SEE PAGE 133					
INAZUMA F	15' - 17'	Z-RACING	7642	410 x 390	+75	4	(*)	
KATANA	19' - 21'	TOURING	3637	355 x 335	+110	3	(*)	(*)
KATANA	19' - 21'	TOURING SCREEN WITH VISOR BOLT-ON	3638H				(*)	
KATANA	19' - 21'	TOURING SCREEN WITH CLIP-ON VISOR	3637 + 6319				(*)	
SFV650 GLADIUS	09' - 15'	NG SPORT / TOURING	SEE PAGE 133					
SV650S	03' - 08'	STANDARD	1344	350 x 375		3		(*)
SV650S	03' - 08'	TOURING	1346	350 x 370		3	(*)	(*)
SV1000S	03' - 05'	STANDARD	1344	350 x 375		3		(*)
SV1000S	03' - 05'	TOURING	1346	350 x 370		3	(*)	(*)

2022		For the new 2022 motorcycle models check www.puig.tv						
MODEL	YEAR	TYPE OF WINDSCREEN	REF.	DIMENSIONS (Height x Width)	HEIGHT (mm) Compared to OEM	THICKNESS (mm)	N W F H	G R T A V C
TL1000R	98' - 99'	STANDARD	0459			3	(*)	
TRIUMPH								
BONNEVILLE BOBBER	17' - 21'	NG SPORT / TOURING	SEE PAGE 133					
DAYTONA 600	03' - 04'	RACING	1928	410 x 370		3		(*)
DAYTONA 650	05'	RACING	1928	410 x 370		3		(*)
DAYTONA 675	13' - 17'	Z-RACING	6498	390 x 300	+30	3	(*)	(*)
DAYTONA 675 R	13' - 17'	Z-RACING	6498	390 x 300	+30	3	(*)	(*)
DAYTONA 955i	01' - 03'	RACING	1927	280 x 410		3	(*)	(*)
ROCKET 3	20'	NG SPORT / TOURING	SEE PAGE 133					
SPEED TRIPLE	05' - 18'	NG SPORT / TOURING	SEE PAGE 133					
SPEED TRIPLE R	12' - 18'	NG SPORT / TOURING	SEE PAGE 133					
SPEED TRIPLE S/RS	19' - 21'	NG SPORT / TOURING	SEE PAGE 133					
STREET TRIPLE	07' - 19'	NG SPORT / TOURING	SEE PAGE 133					
STREET TRIPLE R	08' - 21'	NG SPORT / TOURING	SEE PAGE 133					
STREET TRIPLE S	17' - 21'	NG SPORT / TOURING	SEE PAGE 133					
STREET TRIPLE RS	17' - 21'	NG SPORT / TOURING	SEE PAGE 134					
TIGER 800/ XC	11' - 14'	TOURING	5652 (-)	490 x 430	+130	3	(*)	
TIGER 800/XC	11' - 14'	TOURING SCREEN WITH VISOR BOLT-ON	5918H				(*)	
TIGER 800/XC	11' - 14'	TOURING SCREEN WITH CLIP-ON VISOR	5652 + 6320				(*)	
TIGER 800 XC/XCX/XCA	15' - 17'	TOURING	5652 (-)	490 x 430	+130	3	(*)	
TIGER 800 XC/XCX/XCA	15' - 17'	TOURING SCREEN WITH VISOR BOLT-ON	5918H				(*)	

ANODIZED ALUMINIUM SCREWS AVAILABLE SEE PAGE 102.

R Red	V Green	W Transparent	C Carbon look
T Orange	A Blue	H Smoke	
G Yellow	N Black	F Dark Smoke	

CARBON LOOK: RACING SCREEN AVAILABLE ONLY.
NOTE COLORS: N COLOR DELIVERED WITHOUT SILK PRINT.

(-) Adjustable in width and height.

(*) Check price with your distributor.

IMPORTANT: Indicate code color after part#. Example 0973A.

WINDSCREEN MODELS

HI-TECH PARTS | TYPE OF WINDSCREEN:



STANDARD

Windscreen without supports, form and height are the same as the original windscreen.



SPORT

Windscreen without supports, lower than the original windscreen.



RACING

Doble height Windscreen, it drives the air away from your helmet, for supersport bikes.



Z-RACING

Windscreen with edges in Z form that drives the air away from the helmet. Slightly taller than the original. Wide range of colors.



R-RACER

Windscreen that comes from competition, without edges. Significantly taller than the original one. Available in smoked colors.



NG SPORT / TOURING

Windscreen with adaptor specifically designed for motorcycles that do not have a screen, especially for Naked models.



TOURING

Windscreen taller than the original to provide more protection to the rider.



TOURING PLUS

Windscreen larger than the Puig Touring model, for certain models of motorcycle tourer for maximum aerodynamic protection.



TOURING WITH VISOR

Higher windscreen than the original that incorporates a multi-adjustable screwed visor to divert air from the rider and provide comfort.



TOURING WITH VISOR "CLIP ON"

Higher windscreen than the original to which is assigned a multi-adjustable visor that is fixed with a system called "clip-on" to divert the air from the rider and provide maximum comfort when driving.



ADJUSTABLE

Windscreen that can be adjusted in height, with or without tools and adjust it to the most suitable position for each rider / situation.

2022		For the new 2022 motorcycle models check www.puig.tv					
MODEL	YEAR	TYPE OF WINDSCREEN	REF.	DIMENSIONS (Height x Width)	HEIGHT (mm) Compared to OEM	THICKNESS (mm)	Color Legend
TIGER 800 XC/XCX/XCA	15' - 17'	TOURING SCREEN WITH CLIP-ON VISOR	5652 + 6320				(*)
TIGER 800 XR/XRX/XRT	15' - 17'	TOURING	5652 (-)	490 x 430	+130	3	(*)
TIGER 800 XR/XRX/XRT	15' - 17'	TOURING SCREEN WITH VISOR BOLT-ON	5918H				(*)
TIGER 800 XR/XRX/XRT	15' - 17'	TOURING SCREEN WITH CLIP-ON VISOR	5652 + 6320				(*)
TIGER 800 XC/XCX/XCA/XR/XRX/XRT	18' - 20'	TOURING	9656	550 x 440	+115	4	(*)
TIGER 800 XC/XCX/XCA/XR/XRX/XRT	18' - 20'	TOURING SCREEN WITH VISOR BOLT-ON	9658H				(*)
TIGER 800 XC/XCX/XCA/XR/XRX/XRT	18' - 20'	TOURING SCREEN WITH CLIP-ON VISOR	9656 + 6375				(*)
TIGER 900	20' - 21'	TOURING	20375	560 x 390	+60	4	(*)
TIGER 900	20' - 21'	TOURING SCREEN WITH VISOR BOLT-ON	20376H				(*)
TIGER 900	20' - 21'	TOURING SCREEN WITH CLIP-ON VISOR	20375 + 6320				(*)
TIGER 900 GT	20' - 21'	TOURING	20375	560 x 390	+60	4	(*)
TIGER 900 GT	20' - 21'	TOURING SCREEN WITH VISOR BOLT-ON	20376H				(*)
TIGER 900 GT	20' - 21'	TOURING SCREEN WITH CLIP-ON VISOR	20375 + 6320				(*)
TIGER 900 GT LOW	20' - 21'	TOURING	20375	560 x 390	+60	4	(*)
TIGER 900 GT LOW	20' - 21'	TOURING SCREEN WITH VISOR BOLT-ON	20376H				(*)
TIGER 900 GT LOW	20' - 21'	TOURING SCREEN WITH CLIP-ON VISOR	20375 + 6320				(*)
TIGER 900 GT PRO	20' - 21'	TOURING	20375	560 x 390	+60	4	(*)
TIGER 900 GT PRO	20' - 21'	TOURING SCREEN WITH VISOR BOLT-ON	20376H				(*)

2022		For the new 2022 motorcycle models check www.puig.tv					
MODEL	YEAR	TYPE OF WINDSCREEN	REF.	DIMENSIONS (Height x Width)	HEIGHT (mm) Compared to OEM	THICKNESS (mm)	Color Legend
TIGER 900 GT PRO	20' - 21'	TOURING SCREEN WITH CLIP-ON VISOR	20375 + 6320				(*)
TIGER 900 RALLY	20' - 21'	TOURING	20375	560 x 390	+60	4	(*)
TIGER 900 RALLY	20' - 21'	TOURING SCREEN WITH VISOR BOLT-ON	20376H				(*)
TIGER 900 RALLY	20' - 21'	TOURING SCREEN WITH CLIP-ON VISOR	20375 + 6320				(*)
TIGER 900 RALLY PRO	20' - 21'	TOURING	20375	560 x 390	+60	4	(*)
TIGER 900 RALLY PRO	20' - 21'	TOURING SCREEN WITH VISOR BOLT-ON	20376H				(*)
TIGER 900 RALLY PRO	20' - 21'	TOURING SCREEN WITH CLIP-ON VISOR	20375 + 6320				(*)
TIGER 1050	07' - 13'	TOURING	4359	500 x 355	+75	3	(*)
TIGER 1050	07' - 13'	TOURING SCREEN WITH VISOR BOLT-ON	5919H				(*)
TIGER 1050	07' - 13'	TOURING SCREEN WITH CLIP-ON VISOR	4359 + 6320				(*)
TIGER EXPLORER	12' - 15'	TOURING	6000	560 x 510	+100	3	(*)
TIGER EXPLORER	12' - 15'	TOURING SCREEN WITH VISOR BOLT-ON	6006H				(*)
TIGER EXPLORER	12' - 15'	TOURING SCREEN WITH CLIP-ON VISOR	6000 + 6319				(*)
TIGER EXPLORER XC	13' - 15'	TOURING	6000	560 x 510	+100	3	(*)
TIGER EXPLORER XC	13' - 15'	TOURING SCREEN WITH VISOR BOLT-ON	6006H				(*)

ANODIZED ALUMINIUM SCREWS AVAILABLE SEE PAGE 102.

R Red	V Green	W Transparent	C Carbon look
T Orange	A Blue	H Smoke	
G Yellow	N Black	F Dark Smoke	

CARBON LOOK: RACING SCREEN AVAILABLE ONLY. NOTE COLORS: N COLOR DELIVERED WITHOUT SILK PRINT.

(-) Adjustable in width and height. (*) Check price with your distributor. IMPORTANT: Indicate code color after part#. Example 0973A.

WINDSCREEN MODELS

HI-TECH PARTS | TYPE OF WINDSCREEN:

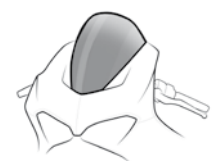

STANDARD

Windscreen without supports, form and height are the same as the original windscreen.



SPORT

Windscreen without supports, lower than the original windscreen.



RACING

Doble height Windscreen, it drives the air away from your helmet, for supersport bikes.

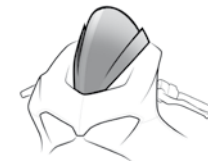

Z-RACING

Windscreen with edges in Z form that drives the air away from the helmet. Slightly taller than the original. Wide range of colors.



R-RACER

Windscreen that comes from competition, without edges. Significantly taller than the original one. Available in smoked colors.



NG SPORT / TOURING

Windscreen with adaptor specifically designed for motorcycles that do not have a screen, especially for Naked models.



TOURING

Windscreen taller than the original to provide more protection to the rider.



TOURING PLUS

Windscreen larger than the Puig Touring model, for certain models of motorcycle tourer for maximum aerodynamic protection.



TOURING WITH VISOR

Higher windscreen than the original that incorporates a multi-adjustable screwed visor to divert air from the rider and provide comfort.



TOURING WITH VISOR "CLIP ON"

Higher windscreen than the original to which is assigned a multi-adjustable visor that is fixed with a system called "clip-on" to divert the air from the rider and provide maximum comfort when driving.



ADJUSTABLE

Windscreen that can be adjusted in height, with or without tools and adjust it to the most suitable position for each rider / situation.

2022		For the new 2022 motorcycle models check www.puig.tv					
MODEL	YEAR	TYPE OF WINDSCREEN	REF.	DIMENSIONS (Height x Width)	HEIGHT (mm) Compared to OEM	THICKNESS (mm)	N W G R T F H A V C
TIGER EXPLORER XC	13' - 15'	TOURING SCREEN WITH CLIP-ON VISOR	6000 + 6319				(*)
TIGER EXPLORER XC/XR/XRX/XRT/XCX/XCA	16' - 17'	TOURING	8915	630 x 410	+90	4	(*)
TIGER EXPLORER XC/XR/XRX/XRT/XCX/XCA	16' - 17'	TOURING SCREEN WITH VISOR BOLT-ON	8916H				(*)
TIGER EXPLORER XC/XR/XRX/XRT/XCX/XCA	16' - 17'	TOURING SCREEN WITH CLIP-ON VISOR	8915 + 6375				(*)
TIGER EXPLORER XC/XR/XRX/XRT/XCX/XCA	18' - 20'	TOURING	9613	620 x 495	+80	4	(*)
TIGER EXPLORER XC/XR/XRX/XRT/XCX/XCA	18' - 20'	TOURING SCREEN WITH VISOR BOLT-ON	9614H				(*)
TIGER EXPLORER XC/XR/XRX/XRT/XCX/XCA	18' - 20'	TOURING SCREEN WITH CLIP-ON VISOR	9613 + 6320				(*)
TIGER 1200 ALPINE	21'	TOURING	9613	620 x 495	+80	4	(*)
TIGER 1200 ALPINE	21'	TOURING SCREEN WITH VISOR BOLT-ON	9614H				(*)
TIGER 1200 ALPINE	21'	TOURING SCREEN WITH CLIP-ON VISOR	9613 + 6320				(*)
TIGER 1200 DESERT	21'	TOURING	9613	620 x 495	+80	4	(*)
TIGER 1200 DESERT	21'	TOURING SCREEN WITH VISOR BOLT-ON	9614H				(*)
TIGER 1200 DESERT	21'	TOURING SCREEN WITH CLIP-ON VISOR	9613 + 6320				(*)
TIGER SPORT	13' - 15'	TOURING	4359	500 x 355	+75	3	(*)
TIGER SPORT	13' - 15'	TOURING SCREEN WITH VISOR BOLT-ON	5919H				(*)
TIGER SPORT	13' - 15'	TOURING SCREEN WITH CLIP-ON VISOR	4359 + 6320				(*)
TIGER SPORT	16' - 20'	TOURING	9200	615 x 440	+120	4	(*)
TIGER SPORT	16' - 20'	TOURING SCREEN WITH VISOR BOLT-ON	9201H				(*)

2022		For the new 2022 motorcycle models check www.puig.tv					
MODEL	YEAR	TYPE OF WINDSCREEN	REF.	DIMENSIONS (Height x Width)	HEIGHT (mm) Compared to OEM	THICKNESS (mm)	N W G R T F H A V C
TIGER SPORT	16' - 20'	TOURING SCREEN WITH CLIP-ON VISOR	9200 + 6320				(*)
TRIDENT 660	21'	NG SPORT / TOURING	SEE PAGE 134				
YAMAHA							
FJR1300	01' - 05'	TOURING	1281	540 x 520	+130	4	(*) (*)
FJR1300A/AS	06' - 12'	TOURING	4103	500 x 505	+35	4	(*) (*)
FJR1300A/AS	13' - 21'	TOURING	6483	560 x 570	+90	4	(*)
FJR1300A/AS	13' - 21'	TOURING SCREEN WITH VISOR BOLT-ON	6501H				(*)
FJR1300A/AS	13' - 21'	TOURING SCREEN WITH CLIP-ON VISOR	6483 + 6375				(*)
FZ1	06' - 15'	NG SPORT / TOURING	SEE PAGE 134				
FZ1 FAZER	06' - 15'	RACING	4061	410 x 300		3	(*) (*)
FZ1 FAZER	06' - 15'	TOURING	4101	480 x 420	+100	3	(*) (*)
FZ1 FAZER	06' - 15'	TOURING SCREEN WITH VISOR BOLT-ON	5907H				(*)
FZ1 FAZER	06' - 15'	TOURING SCREEN WITH CLIP-ON VISOR	4101 + 6320				(*)
FZ6 FAZER	04' - 08'	RACING	1646	550 x 570		3	(*) (*)
FZ6 FAZER	04' - 08'	TOURING	1647	590 x 540	+90	3	(*)
FZ6 FAZER S2	07' - 10'	RACING	4366	420 x 330		3	(*) (*)
FZ6 FAZER S2	07' - 10'	TOURING	4367	475 x 335	+100	3	(*) (*)
FZ6 FAZER S2	07' - 10'	TOURING SCREEN WITH VISOR BOLT-ON	5908H				(*)

ANODIZED ALUMINIUM SCREWS AVAILABLE SEE PAGE 102.

R Red	V Green	W Transparent	C Carbon look
T Orange	A Blue	H Smoke	
G Yellow	N Black	F Dark Smoke	

CARBON LOOK: RACING SCREEN AVAILABLE ONLY.
NOTE COLORS: N COLOR DELIVERED WITHOUT SILK PRINT.

(-) Adjustable in width and height.
 (*) Check price with your distributor.
IMPORTANT: Indicate code color after part#. Example 0973A.

WINDSCREEN MODELS

HI-TECH PARTS | TYPE OF WINDSCREEN:



STANDARD

Windscreen without supports, form and height are the same as the original windscreen.



SPORT

Windscreen without supports, lower than the original windscreen.



RACING

Doble height Windscreen, it drives the air away from your helmet, for supersport bikes.



Z-RACING

Windscreen with edges in Z form that drives the air away from the helmet. Slightly taller than the original. Wide range of colors.



R-RACER

Windscreen that comes from competition, without edges. Significantly taller than the original one. Available in smoked colors.



NG SPORT / TOURING

Windscreen with adaptor specifically designed for motorcycles that do not have a screen, especially for Naked models.



TOURING

Windscreen taller than the original to provide more protection to the rider.



TOURING PLUS

Windscreen larger than the Puig Touring model, for certain models of motorcycle tourer for maximum aerodynamic protection.



TOURING WITH VISOR

Higher windscreen than the original that incorporates a multi-adjustable screwed visor to divert air from the rider and provide comfort.



TOURING WITH VISOR "CLIP ON"

Higher windscreen than the original to which is assigned a multi-adjustable visor that is fixed with a system called "clip-on" to divert the air from the rider and provide maximum comfort when driving.



ADJUSTABLE

Windscreen that can be adjusted in height, with or without tools and adjust it to the most suitable position for each rider / situation.

2022		For the new 2022 motorcycle models check www.puig.tv					
MODEL	YEAR	TYPE OF WINDSCREEN	REF.	DIMENSIONS (Height x Width)	HEIGHT (mm) Compared to OEM	THICKNESS (mm)	Color Legend
FZ6 FAZER S2	07' - 10'	TOURING SCREEN WITH CLIP-ON VISOR	4367 + 6320				(*)
FZ8	10' - 16'	NG SPORT / TOURING	SEE PAGE 134				
MT-125	14' - 21'	NG SPORT / TOURING	SEE PAGE 134				
MT-03	16' - 21'	NG SPORT / TOURING	SEE PAGE 134				
MT-07	14' - 21'	NG SPORT / TOURING	SEE PAGE 134				
MT-07 TRACER	16' - 19*	Z-RACING	9211	406 x 290	-50	4	(*)
MT-07 TRACER	16' - 19'	TOURING	9212	600 x 360	+150	4	(*)
MT-07 TRACER	16' - 19'	TOURING SCREEN WITH VISOR BOLT-ON	9213H				(*)
MT-07 TRACER	16' - 19'	TOURING SCREEN WITH CLIP-ON VISOR	9212 + 6375				(*)
MT-07 TRACER	20' - 21'	SPORT	20433	382 x 250	+0	4	(*)
MT-07 TRACER	20' - 21'	TOURING	20434	583 x 375	+150	4	(*)
MT-07 TRACER	20' - 21'	TOURING SCREEN WITH VISOR BOLT-ON	20435				(*)
MT-07 TRACER	20' - 21'	TOURING SCREEN WITH CLIP-ON VISOR	20434 + 6375				(*)
MT-07 TRACER GT	19'	Z-RACING	9211	406 x 290	-50	4	(*)
MT-07 TRACER GT	19'	TOURING	9212	600 x 360	+150	4	(*)
MT-07 TRACER GT	19'	TOURING SCREEN WITH VISOR BOLT-ON	9213H				(*)
MT-07 TRACER GT	19'	TOURING SCREEN WITH CLIP-ON VISOR	9212+6375				(*)
MT-07 TRACER GT	20' - 21'	SPORT	20433	382 x 250	+0	4	(*)
MT-07 TRACER GT	20' - 21'	TOURING	20434	583 x 375	+150	4	(*)
MT-07 TRACER GT	20' - 21'	TOURING SCREEN WITH VISOR BOLT-ON	20435				(*)
MT-07 TRACER GT	20' - 21'	TOURING SCREEN WITH CLIP-ON VISOR	20434 + 6375				(*)

2022		For the new 2022 motorcycle models check www.puig.tv					
MODEL	YEAR	TYPE OF WINDSCREEN	REF.	DIMENSIONS (Height x Width)	HEIGHT (mm) Compared to OEM	THICKNESS (mm)	Color Legend
MT-09	13' - 21'	NG SPORT / TOURING	SEE PAGE 134				
MT-09 SP	18' - 21'	NG SPORT / TOURING	SEE PAGE 134				
MT-09 TRACER	15' - 17'	SPORT	7645	390 x 290	-60	3	(*) (*)
MT-09 TRACER	15' - 17'	TOURING	7646	640 x 405	+160	3	(*)
MT-09 TRACER	18' - 21'	SPORT	9724	376 x 287	-140	4	(*)
MT-09 TRACER	18' - 20'	TOURING	9725	645 x 445	+105	4	(*)
MT-09 TRACER	18' - 20'	TOURING SCREEN WITH VISOR BOLT-ON	9726H				(*)
MT-09 TRACER	18' - 20'	TOURING SCREEN WITH CLIP-ON VISOR	9725 + 6375				(*)
MT-09 TRACER	21'	TOURING	3762	645 x 445		4	(*)
MT-09 TRACER	21'	TOURING SCREEN WITH VISOR BOLT-ON	3755H				(*)
MT-09 TRACER	21'	TOURING SCREEN WITH CLIP-ON VISOR	3762 + 6375				(*)
MT-09 TRACER GT	18' - 21'	SPORT	9724	376 x 287	-140	4	(*)
MT-09 TRACER GT	18' - 20'	TOURING	9725	645 x 445	+105	4	(*)
MT-09 TRACER GT	18' - 20'	TOURING SCREEN WITH VISOR BOLT-ON	9726H				(*)
MT-09 TRACER GT	18' - 20'	TOURING SCREEN WITH CLIP-ON VISOR	9725 + 6375				(*)
MT-09 TRACER GT	21'	TOURING	3762	645 x 445		4	(*)
MT-09 TRACER GT	21'	TOURING SCREEN WITH VISOR BOLT-ON	3755H				(*)

■ R Red ■ V Green ■ W Transparent ■ C Carbon look
■ T Orange ■ A Blue ■ H Smoke
■ G Yellow ■ N Black ■ F Dark Smoke

ANODIZED ALUMINIUM SCREWS AVAILABLE SEE PAGE 102.

CARBON LOOK: RACING SCREEN AVAILABLE ONLY.
NOTE COLORS: N COLOR DELIVERED WITHOUT SILK PRINT.

(-) Adjustable in width and height.

(*) Check price with your distributor.

IMPORTANT: Indicate code color after part#. Example 0973A.

WINDSCREEN MODELS

HI-TECH PARTS | TYPE OF WINDSCREEN:



STANDARD

Windscreen without supports, form and height are the same as the original windscreen.



SPORT

Windscreen without supports, lower than the original windscreen.



RACING

Doble height Windscreen, it drives the air away from your helmet, for supersport bikes.

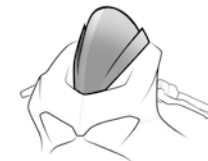

Z-RACING

Windscreen with edges in Z form that drives the air away from the helmet. Slightly taller than the original. Wide range of colors.



R-RACER

Windscreen that comes from competition, without edges. Significantly taller than the original one. Available in smoked colors.



NG SPORT / TOURING

Windscreen with adaptor specifically designed for motorcycles that do not have a screen, especially for Naked models.



TOURING

Windscreen taller than the original to provide more protection to the rider.



TOURING PLUS

Windscreen larger than the Puig Touring model, for certain models of motorcycle tourer for maximum aerodynamic protection.



TOURING WITH VISOR

Higher windscreen than the original that incorporates a multi-adjustable screwed visor to divert air from the rider and provide comfort.



TOURING WITH VISOR "CLIP ON"

Higher windscreen than the original to which is assigned a multi-adjustable visor that is fixed with a system called "clip-on" to divert the air from the rider and provide maximum comfort when driving.



ADJUSTABLE

Windscreen that can be adjusted in height, with or without tools and adjust it to the most suitable position for each rider / situation.

2022		For the new 2022 motorcycle models check www.puig.tv						
MODEL	YEAR	TYPE OF WINDSCREEN	REF.	DIMENSIONS (Height x Width)	HEIGHT (mm) Compared to OEM	THICKNESS (mm)	N W G R T F H A V C	
MT-09 TRACER GT	21'	TOURING SCREEN WITH CLIP-ON VISOR	3762 + 6375				(*)	
MT-10	16' - 21'	TOURING	8917	365 x 325	+70	3	(*) (*)	
MT-10	16' - 21'	TOURING PLUS	8918	540 x 360	+225	4	(*) (*)	
MT-10	16' - 21'	TOURING PLUS SCREEN WITH VISOR BOLT-ON	8919H				(*)	
MT-10	16' - 21'	TOURING PLUS SCREEN WITH CLIP-ON VISOR	8918 + 6320				(*)	
MT-10 SP	17' - 21'	TOURING	8917	365 x 325	+70	3	(*) (*)	
MT-10 SP	17' - 21'	TOURING PLUS	8918	540 x 360	+225	4	(*) (*)	
MT-10 SP	17' - 21'	TOURING PLUS SCREEN WITH VISOR BOLT-ON	8919H				(*)	
MT-10 SP	17' - 21'	TOURING PLUS SCREEN WITH CLIP-ON VISOR	8918 + 6320				(*)	
NIKEN	18' - 21'	TOURING	2385	608 x 490	+300	4	(*)	
NIKEN	18' - 21'	TOURING SCREEN WITH VISOR BOLT-ON	3535H				(*)	
NIKEN	18' - 21'	TOURING SCREEN WITH CLIP-ON VISOR	2385+6320				(*)	
TENERE 700	19' - 21'	TOURING	3727	415 x 310	+80	3	(*)	
TENERE 700	19' - 21'	TOURING SCREEN WITH VISOR BOLT-ON	3728H				(*)	
TENERE 700	19' - 21'	TOURING SCREEN WITH CLIP-ON VISOR	3727 + 6319				(*)	
TENERE 700	19' - 21'	SPORT	20834	240 x 250	-50	3	(*)	
TENERE 700 RALLE EDITION	21'	TOURING	3727	415 x 310	+80	3	(*)	
TENERE 700 RALLE EDITION	21'	TOURING SCREEN WITH VISOR BOLT-ON	3728H				(*)	
TENERE 700 RALLE EDITION	21'	TOURING SCREEN WITH CLIP-ON VISOR	3727 + 6319				(*)	

2022		For the new 2022 motorcycle models check www.puig.tv						
MODEL	YEAR	TYPE OF WINDSCREEN	REF.	DIMENSIONS (Height x Width)	HEIGHT (mm) Compared to OEM	THICKNESS (mm)	N W G R T F H A V C	
TENERE 700 RALLE EDITION	21'	SPORT	20834	240 x 250	-50	3	(*)	
TDM 900	02' - 13'	STANDARD	1106				(*)	
TZR50	03' - 16'	STANDARD	1596	365 x 300		3	(*)	
VMAX	09' - 16'	NG SPORT / TOURING	SEE PAGE 135					
XJ6	09' - 16'	NG SPORT / TOURING	SEE PAGE 135					
XJ6 DIVERSION F	10' - 16'	TOURING	5547	390 x 260		3	(*) (*)	
XJ6 DIVERSION F	10' - 16'	TOURING PLUS	5548	500 x 360	+130	3	(*)	
XJ6 DIVERSION F	10' - 16'	TOURING PLUS SCREEN WITH VISOR BOLT-ON	5910H				(*)	
XJ6 DIVERSION F	10' - 16'	TOURING PLUS SCREEN WITH CLIP-ON VISOR	5548 + 6320				(*)	
XT660Z TÉNÉRÉ	08' - 16'	TOURING	4636	385 x 470	+80	3	(*) (*)	
XT660Z TÉNÉRÉ	08' - 16'	TOURING SCREEN WITH VISOR BOLT-ON	5912H				(*)	
XT660Z TÉNÉRÉ	08' - 16'	TOURING SCREEN WITH CLIP-ON VISOR	4636 + 6319				(*)	
XT1200Z SUPER TÉNÉRÉ	10' - 13'	TOURING	5568	505 x 450	+80	3	(*)	
XT1200Z SUPER TÉNÉRÉ	10' - 13'	TOURING SCREEN WITH VISOR BOLT-ON	5911H				(*)	
XT1200Z SUPER TÉNÉRÉ	10' - 13'	TOURING SCREEN WITH CLIP-ON VISOR	5568 + 6375				(*)	
XT1200Z SUPER TÉNÉRÉ	14' - 21'	TOURING	7541	600 x 465	+140	4	(*)	
XT1200Z SUPER TÉNÉRÉ	14' - 21'	TOURING SCREEN WITH VISOR BOLT-ON	7600H				(*)	

ANODIZED ALUMINIUM SCREWS AVAILABLE SEE PAGE 102.

R Red
 V Green
 W Transparent
 C Carbon look

T Orange
 A Blue
 H Smoke
 F Dark Smoke

G Yellow
 N Black

CARBON LOOK: RACING SCREEN AVAILABLE ONLY.
NOTE COLORS: N COLOR DELIVERED WITHOUT SILK PRINT.

(-) Adjustable in width and height.

(*) Check price with your distributor.

IMPORTANT: Indicate code color after part#. Example 0973A.

WINDSCREEN MODELS

HI-TECH PARTS | TYPE OF WINDSCREEN:

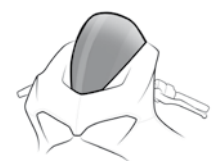

STANDARD

Windscreen without supports, form and height are the same as the original windscreen.



SPORT

Windscreen without supports, lower than the original windscreen.



RACING

Doble height Windscreen, it drives the air away from your helmet, for supersport bikes.

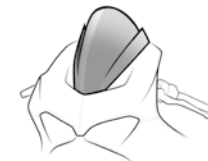

Z-RACING

Windscreen with edges in Z form that drives the air away from the helmet. Slightly taller than the original. Wide range of colors.



R-RACER

Windscreen that comes from competition, without edges. Significantly taller than the original one. Available in smoked colors.



NG SPORT / TOURING

Windscreen with adaptor specifically designed for motorcycles that do not have a screen, especially for Naked models.



TOURING

Windscreen taller than the original to provide more protection to the rider.

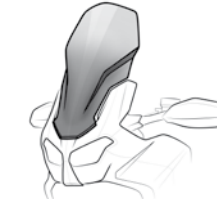

TOURING PLUS

Windscreen larger than the Puig Touring model, for certain models of motorcycle tourer for maximum aerodynamic protection.



TOURING WITH VISOR

Higher windscreen than the original that incorporates a multi-adjustable screwed visor to divert air from the rider and provide comfort.



TOURING WITH VISOR "CLIP ON"

Higher windscreen than the original to which is assigned a multi-adjustable visor that is fixed with a system called "clip-on" to divert the air from the rider and provide maximum comfort when driving.



ADJUSTABLE

Windscreen that can be adjusted in height, with or without tools and adjust it to the most suitable position for each rider / situation.

2022		For the new 2022 motorcycle models check www.puig.tv					
MODEL	YEAR	TYPE OF WINDSCREEN	REF.	DIMENSIONS (Height x Width)	HEIGHT (mm) Compared to OEM	THICKNESS (mm)	N W G R T F H A V C
XT1200Z SUPER TENERÉ	14' - 21'	TOURING SCREEN WITH CLIP-ON VISOR	7541 + 6320				(*)
XT1200ZE SUPER TENERE	19' - 21'	TOURING	7541	600 x 465	+140	4	(*)
XT1200ZE SUPER TENERE	19' - 21'	TOURING SCREEN WITH VISOR BOLT-ON	7600H				(*)
XT1200ZE SUPER TENERE	19' - 21'	TOURING SCREEN WITH CLIP-ON VISOR	7541 + 6320				(*)
XV950/R	14' - 21'	NG SPORT / TOURING	SEE PAGE 135				
XV950 RACER	14' - 21'	NG SPORT / TOURING	SEE PAGE 135				
YZF 600 R THUNDERCAT	96' - 02'	STANDARD	0594			3	(*)
YZF 600 R THUNDERCAT	96' - 02'	RACING	1124	330 x 390		3	(*)
YZF-R125	08' - 18'	RACING	4637	370 x 255	+45	3	(*) (*)
YZF-R125	19' - 21'	Z-RACING	3619	330 x 310	+35	3	(*) (*)
YZF-R1	02' - 03'	RACING	1145	415 x 300		3	(*)
YZF-R1	04' - 06'	RACING	1650	480 x 330		3	(*) (*)
YZF-R1	07' - 08'	STANDARD	4364	450 x 380		3	(*)
YZF-R1	07' - 08'	RACING	4365	420 x 350		3	(*) (*)
YZF-R1	09' - 14'	Z-RACING	4935	450 x 360		3	(*) (*)
YZF-R1	15' - 19'	Z-RACING	7648	360 x 300	+30	3	(*) (*)
YZF-R1	15' - 19'	R-RACER	3632	365 x 305	+245 a reloj	3	(*)
YZF-R1	20' - 21'	Z-RACING	3826	335 x 295	+30	3	(*) (*)
YZF-R1	20' - 21'	R-RACER	3827	335 x 298	+70	3	(*)
YZF-R1M	17' - 19'	Z-RACING	7648	360 x 300		3	(*) (*)
YZF-R1M	17' - 19'	R-RACER	3632	365 x 305	+245 a reloj	3	(*)
YZF-R1M	20' - 21'	Z-RACING	3826	335 x 295	+30	3	(*) (*)
YZF-R1M	20' - 21'	R-RACER	3827	335 x 298	+70	3	(*)
YZF-R3	15' - 18'	Z-RACING	7649	300 x 295	+30	3	(*) (*)
YZF-R3	19' - 21'	R-RACER	3737	330 x 280	+185	3	(*)
YZF-R6	99' - 02'	RACING	0021	310 x 360		3	
YZF-R6	99' - 02'	TOURING	0626	360 x 350	+3	3	(*) (*)

2022		For the new 2022 motorcycle models check www.puig.tv					
MODEL	YEAR	TYPE OF WINDSCREEN	REF.	DIMENSIONS (Height x Width)	HEIGHT (mm) Compared to OEM	THICKNESS (mm)	N W G R T F H A V C
YZF-R6	03' - 05'	RACING	1328	450 x 380		3	(*) (*)
YZF-R6	06' - 07'	STANDARD	4058	345 x 345		3	(*) (*)
YZF-R6	06' - 07'	RACING	4059	320 x 370		3	(*) (*)
YZF-R6	08' - 16'	STANDARD	4634			3	(*)
YZF-R6	08' - 16'	Z-RACING	4635	350 x 370		3	(*) (*)
YZF-R6	17' - 20'	Z-RACING	9723	360 x 285	+30	3	(*) (*)
YZF-R6	17' - 20'	R-RACER	3633	370 x 280	+40	3	(*)
YZF-R6 RACE	21'	Z-RACING	9723	360 x 285	+30	3	(*) (*)
YZF-R6 RACE	21'	R-RACER	3633	370 x 280	+40	3	(*)

R Red	V Green	W Transparent	C Carbon look
T Orange	A Blue	H Smoke	
G Yellow	N Black	F Dark Smoke	

ANODIZED ALUMINIUM SCREWS AVAILABLE SEE PAGE 102.

CARBON LOOK: RACING SCREEN AVAILABLE ONLY.
NOTE COLORS: N COLOR DELIVERED WITHOUT SILK PRINT.

(-) Adjustable in width and height.

(*) Check price with your distributor.

IMPORTANT: Indicate code color after part#. Example 0973A.

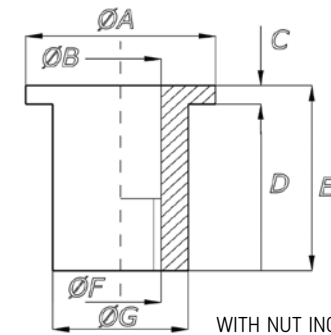

WITH NUT INCORPORATED (25 UNITS IN SAC)

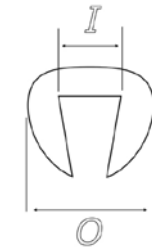

SCREEN SCREWS

MODEL	REF.	Color Code
BLISTER 8 SCREWS M5 WITH NUTS	0956	(*)
BLISTER 8 SCREWS M5 WITH WELLNUTS	0957	(*)

- R Red
- N Black
- O Gold
- A Blue
- L Violet
- P Silver
- V Green

(*) Check price with your distributor.
 IMPORTANT: Indicate code color after part#. Example 0973A.

ANODIZED SCREWS KIT

MODEL	REF.	Color Code
BLISTER 6 ALLEN HEAD SCREWS M5 x 15 mm.	0543	(*)
BLISTER 6 ALLEN HEAD SCREWS M5 x 20 mm.	0550	(*)
BLISTER 6 ALLEN HEAD SCREWS M5 x 25 mm.	0610	(*)
BLISTER 6 ALLEN HEAD SCREWS M6 x 15 mm.	0611	(*)
BLISTER 6 ALLEN HEAD SCREWS M6 x 20 mm.	0657	(*)
BLISTER 6 ALLEN HEAD SCREWS M6 x 25 mm.	0689	(*)

WELLNUTS

AxBxCxDxExG	REF.	Color Code
14 x 6 x 1,5 x 13,5 x 15 x 10 M5	0714N	(*)
15 x 7 x 1,5 x 13,5 x 15 x 12,5 M6	0715N	(*)
14 x 5 x 1,5 x 11,5 x 13 x 10 M4	1887N	(*)

- R Red
- N Black
- G Yellow
- A Blue
- L Violet
- H Smoke
- V Green
- P Silver

(*) Check price with your distributor.
 IMPORTANT: Indicate code color after part#. Example 0973A.

TRIM-ENDING

O x I	COLOR	REF.	ROLL	Color Code
6,2 x 2,6	TRANSPARENT	0900W	250 mts.	(*)
6,2 x 2,6	SMOKE	0900H	250 mts.	(*)
6,2 x 2,6	TRANSPARENT	5843W	2 mts.	(*)
6,2 x 2,6	SMOKE	5843H	2 mts.	(*)



SEMIFAIRING RALLY

HI-TECH PARTS | TECHNICAL SECTION

Puig
Off-Road

NEW!

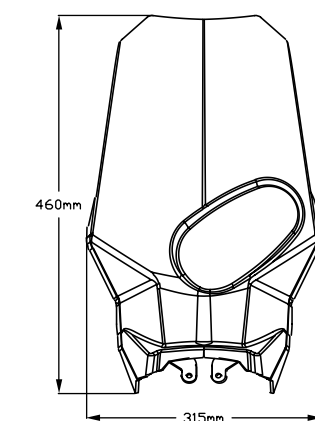

REF. 20507

The Rally semifairing is a complement for your off-road motorcycle that will allow you to:

- Improve aerodynamics thanks to the polycarbonate screen that redirects the air, improving the rider's protection.
- Improve lighting thanks to two LED headlights if we compare them to the originals of the motorcycle.
- Install the navigation system that best suits your needs, such as a Roadbook, Mobile Phone or a GPS and adjust it to the position you want, resisting the bumps and jumps that may occur when on the road. It should also be noted that your navigation system will be 100% protected by the screen from possible impacts, stones, dust...

MODEL	YEAR	REF.	Ⓜ
KTM			
125EXC	09'-13'	20507	(*)
125EXC	14'-16'	20507	(*)
200EXC	09'-13'	20507	(*)
200EXC	14'-16'	20507	(*)
250EXC	08'-13'	20507	(*)
250EXC	14'-21'	20507	(*)
300EXC	08'-13'	20507	(*)
300EXC	14'-21'	20507	(*)
400EXC	09'-11'	20507	(*)
450EXC	08'-13'	20507	(*)
450EXC	14'-16'	20507	(*)
500EXC	12'-13'	20507	(*)
500EXC	14'-16'	20507	(*)

MODEL	YEAR	REF.	Ⓜ
530EXC	09'-11'	20507	(*)
HUSQVARNA			
ENDURO 701	16' - 20'	20548	(*)
FE250	14'-16'	20548	(*)
FE250	17'-21'	20548	(*)
FE501	14'-16'	20548	(*)
FE501	17'-21'	20548	(*)
FE501S	14'-16'	20548	(*)
FE 501S	17'-21'	20548	(*)
TE125	14'-16'	20548	(*)
TE250	14'-16'	20548	(*)
TE250	17'	20548	(*)
TE300	14'-16'	20548	(*)
TE300	17'	20548	(*)

 W Transparent

NOTE: THE SEMIFAIRINGS ARE SERVED WITH AN ADHESIVE KIT THAT USES THE SAME AESTHETIC AND COLORS AS THE MOTORCYCLE.

(*) Check price with your distributor.

IMPORTANT: Indicate code color after part#. Example 0973A.



M.E.M.

HI-TECH PARTS | TECHNICAL SECTION

M.E.M. (Manual Elevation System)

Compact mechanism that allows you to modify the position of the screen of your motorcycle without tools so you can adapt to the different situations that the route demands, raising it and increasing the aerodynamic protection on fast roads or adverse weather conditions, or reducing it in city or offroad driving for a wide field of view without interference, or for a more sport look.

You will be able to activate the mechanism and place the screen in the position you want with a quick and easy twist on the fixings, and fix it again with just your hands, without the need for tools. The mechanism is used for your OEM screen or for Puig screens for your motorcycle.



LOWEST POSITION

HIGHEST POSITION



Aerodynamic tests supplied along with most of our windscreens.



MECHANISM REF. 9955N



MECHANISM REF. 9955N



MECHANISM REF. 20504N



MODEL	YEAR	TYPE	REF.	N
HONDA				
CRF1000L AFRICA TWIN	16' - 19'	M.E.M. + TOURING PLUS SCREEN WITH SCREW FIXED VISOR	9157	(*)
CRF1000L AFRICA TWIN ADVENTURE SPORTS	18' - 19'	M.E.M. + TOURING PLUS SCREEN WITH SCREW FIXED VISOR	9157	(*)
CRF1000L AFRICA TWIN	16' - 19'	M.E.M.	(#) 3493N	(*)
CRF1000L AFRICA TWIN	16' - 19'	M.E.M.	(#) 9154N	(*)
CRF1000L AFRICA TWIN	16' - 19'	M.E.M. + TOURING SCREEN	3714	(*)
CRF1000L AFRICA TWIN	16' - 19'	M.E.M. + TOURING SCREEN	9156	(*)
CRF1000L AFRICA TWIN	16' - 19'	M.E.M. + TOURING PLUS SCREEN WITH "CLIP-ON" VISOR	9156 + 6319	(*)
CRF1000L AFRICA TWIN ADVENTURE SPORTS	18' - 19'	M.E.M.	(#) 3493N	(*)
CRF1000L AFRICA TWIN ADVENTURE SPORTS	18' - 19'	M.E.M.	(#) 9154N	(*)
CRF1000L AFRICA TWIN ADVENTURE SPORTS	16' - 19'	M.E.M. + TOURING SCREEN	3714	(*)
CRF1000L AFRICA TWIN ADVENTURE SPORTS	18' - 19'	M.E.M. + TOURING SCREEN	9156	(*)
CRF1000L AFRICA TWIN ADVENTURE SPORTS	18' - 19'	M.E.M. + TOURING PLUS SCREEN WITH "CLIP-ON" VISOR	9156 + 6319	(*)
NC750X	21'	M.E.M.	20757	(*)
NC750X	21'	M.E.M. + TOURING SCREEN	20758	(*)
KTM				
790 ADVENTURE/R	19' - 21'	M.E.M.	20504	(*)
890 ADVENTURE	21'	M.E.M.	20504	(*)
890 ADVENTURE R	21'	M.E.M.	20504	(*)
890 ADVENTURE R RALLY	21'	M.E.M.	20504	(*)
YAMAHA				
MT-09	17' - 20'	M.E.M.	(-) 9955N	(*)
MT-09 SP	18' - 20'	M.E.M.	(-) 9955N	(*)
TENERE 700	19' - 21'	M.E.M.	(#) 3732N	(*)
TENERE 700 RALLY EDITION	19' - 21'	M.E.M.	(#) 3732N	(*)

(#) Compatible with Puig and OEM screen.

(-) Compatible only with Puig screen Ref.9955.

(*) Check price with your distributor.

IMPORTANT: Indicate code color after part#. Example 0973A.



E.R.S.

HI-TECH PARTS | TECHNICAL SECTION

E.R.S.

(Electronic Regulation System)

Electronic mechanism, easy assembly, which allows the movement of the screen easily by operating a commutator even piloting the motorcycle.

It has a height of 150 mm. To regulate at will of pilot, according to his height and the meteorological conditions.

Improves pilot comfort.

It can be mounted with both the Puig dome and the original one.



LOWEST POSITION



HIGHEST POSITION



AUTOMATIC



PLUG & PLAY



MECHANISM

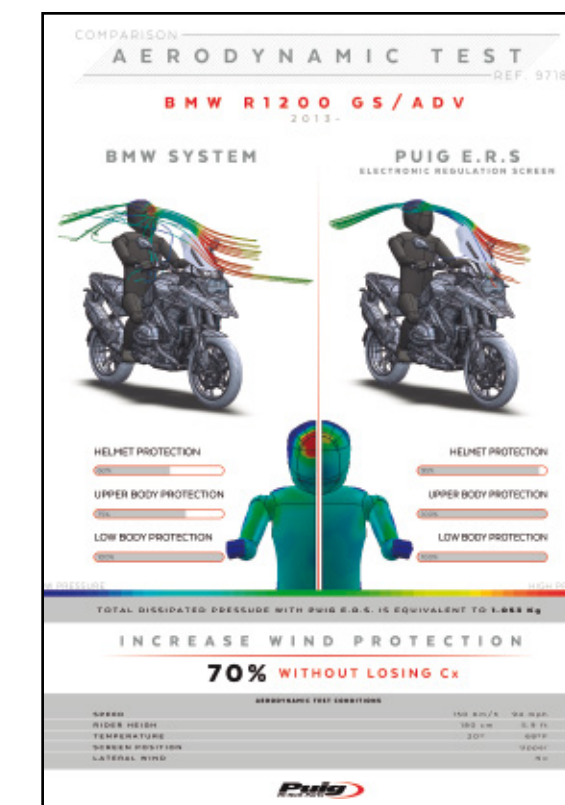

Aerodynamic tests supplied along with most of our windscreens.

■ N Black

MODEL	YEAR	REF.	N
BMW			
F750GS	18' - 21'	3157N	(*)
F850GS	18' - 21'	3157N	(*)
F850GS ADVENTURE	19' - 21'	3689N	(*)
R1200GS	13' - 18'	9718N	(*)
R1200GS ADVENTURE	14' - 18'	9718N	(*)
R1200GS EXCLUSIVE	17' - 18'	9718N	(*)
R1200GS RALLYE	17' - 18'	9718N	(*)
R1250GS	18' - 21'	9718N	(*)
R1250GS HP	18' - 21'	9718N	(*)
R1250GS ADVENTURE	18' - 21'	9718N	(*)
R1250GS RALLYE	18' - 21'	9718N	(*)
TRIUMPH			
TIGER 800 XC/XCX/XCA/XR/XRX/XRT	18' - 20'	3654N	(*)
YAMAHA			
MT-09 TRACER	18' - 20'	3622N	(*)
MT-09 TRACER GT	18' - 20'	3622N	(*)

(*) Check price with your distributor.
IMPORTANT: Indicate code color after part#. Example 0973A.



WINDSHIELDS FOR MAXISCOOTERS

HI-TECH PARTS | TECHNICAL SECTION



SCREEN TESTED IN THE VIRTUAL WIND TUNNEL

The V-Tech design has been developed through our Virtual Wind Tunnel to improve and OEM aerodynamic penetration. Its angulated shapes on its central and side sections eases the wind canalization redirecting it to both sides of the rider, minimizing turbulences and keeping the radical look of the pieces.



PUIG



OEM

Improved aerodynamics and wind protection on average +24%.

REF.1666



PUIG



OEM

Wind pressure comparison between V-Tech Line Puig and OEM.



www.puig.tv info@puig.tv
www.puigusa.com info@puigusa.com

YAMAHA T-MAX 560

V-TECH LINE SPORT / TOURING

REF 9423-9424



CHECK COMPARATIVE STUDIES FOR ALL OUR V-TECH LINE SCREENS IN OUR WEBSITE.

WINDSHIELDS FOR MAXISCOOTERS

HI-TECH PARTS | TYPE OF WINDSCREEN:



Only V-TECH LINE SPORT

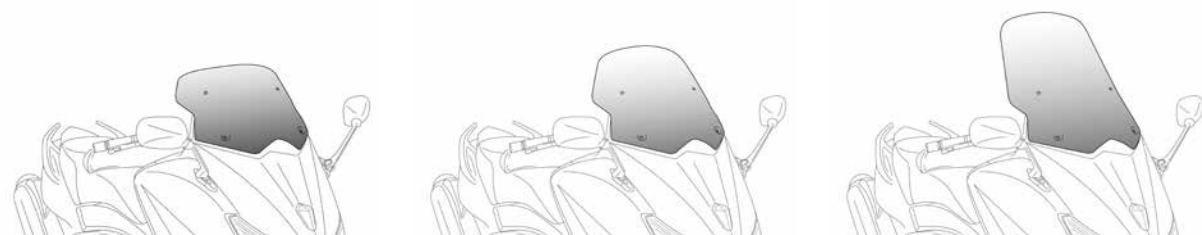

V-TECH LINE SUPERSPORT

V-TECH LINE SPORT

V-TECH LINE TOURING

2022		For the new 2022 motorcycle models check www.puig.tv						
MODEL	YEAR	TYPE OF V-TECH LINE	REF.	DIMENSIONS (Height x Width)	HEIGHT (mm) Compared to OEM	THICKNESS (mm)		
BMW								
C400X	19' - 21'	V-TECH LINE TOURING	20732	690 x 555	+210	4	(*)	
C400GT	19' - 21'	V-TECH LINE TOURING	20732	690 x 555	+210	4	(*)	
C600 SPORT	12' - 15'	V-TECH LINE SPORT	6031	600 x 410	-50	4	(*)	
C600 SPORT	12' - 15'	V-TECH LINE TOURING	9015	715 x 465	+70	4	(*)	
C650 SPORT	16' - 20'	V-TECH LINE SPORT	9014	580 x 415	-70	4	(*)	
C650 SPORT	16' - 20'	V-TECH LINE TOURING	9015	700 x 470	+110	4	(*)	
C EVOLUTION	15' - 20'	V-TECH LINE TOURING	1769	915 x 810	+415	4	(*)	
HONDA								
FORZA 125	15' - 17'	V-TECH LINE TOURING	7662	590 x 410	+115	4	(*)	
FORZA 125	18' - 20'	V-TECH LINE TOURING	1295	590 x 410	+115	4	(*)	
FORZA 125	21'	V-TECH LINE TOURING	20679	600 x 405	+140	4	(*)	
FORZA 300	18' - 20'	V-TECH LINE TOURING	1295	590 x 410	+115	4	(*)	
FORZA 350	21'	V-TECH LINE TOURING	20679	600 x 405	+140	4	(*)	
FORZA 750	21'	V-TECH LINE TOURING	20574	745 x 710	+100	4	(*)	
FORZA 750	21'	V-TECH LINE SPORT	20578	430 x 330	-210	4	(*)	
INTEGRA 700	12' - 13'	V-TECH LINE SPORT	6283	510 x 370	-90	4	(*)	
INTEGRA 700	12' - 13'	V-TECH LINE TOURING	6035	645 x 445	+60	4	(*)	
INTEGRA 750	14' - 21'	V-TECH LINE SPORT	6283	510 x 370	-90	4	(*)	
INTEGRA 750	14' - 21'	V-TECH LINE TOURING	6035	645 x 445	+60	4	(*)	
INTEGRA 750S	14' - 16'	V-TECH LINE TOURING	6035	645 x 445	+60	4	(*)	
PCX 125	10' - 13'	V-TECH LINE TOURING	5569	530 x 360	+140	4	(*)	
PCX 125	18' - 20'	V-TECH LINE TOURING	9789	850 x 640	+400	4	(*)	
PCX 125	21'	V-TECH LINE TOURING	20637	670 x 495	+200	4	(*)	
PCX 150	18' - 20'	V-TECH LINE TOURING	9789	850 x 640	+400	4	(*)	
PCX 150	21'	V-TECH LINE TOURING	20637	670 x 495	+200	4	(*)	
KAWASAKI								
J125	16' - 21'	V-TECH LINE TOURING	7020	740 x 575	+185	4	(*)	
J300	14' - 21'	V-TECH LINE TOURING	7020	740 x 575	+185	4	(*)	

2022		For the new 2022 motorcycle models check www.puig.tv						
MODEL	YEAR	TYPE OF V-TECH LINE	REF.	DIMENSIONS (Height x Width)	HEIGHT (mm) Compared to OEM	THICKNESS (mm)		
KEEWAY								
CITYBLADE 125	13' - 20'	V-TECH LINE TOURING	8167	615 X 350	275	4	(*)	
VIESTE	21'	V-TECH LINE TOURING	20713	615 X 350	+260	4	(*)	
KYMCO								
AK550	17' - 21'	V-TECH LINE SPORT	9478	555 x 395	+60	4	(*)	
AK550	17' - 21'	V-TECH LINE TOURING	9477	800 x 645	-185	4	(*)	
DOWNTOWN 125i	09' - 14'	V-TECH LINE SPORT	5522	540 x 460	-120	4	(*)	
DOWNTOWN 125i	09' - 14'	V-TECH LINE TOURING	6790	750 x 615	+130	4	(*)	
DOWNTOWN 300i	09' - 14'	V-TECH LINE SPORT	5522	540 x 460	-120	4	(*)	
DOWNTOWN 300i	09' - 14'	V-TECH LINE TOURING	6790	750 x 615	+130	4	(*)	
GRAND DINK 125	16' - 20'	V-TECH LINE SPORT	5522	540 x 460	-120	4	(*)	
GRAND DINK 125	16' - 20'	V-TECH LINE TOURING	6790	750 x 615	+130	4	(*)	
GRAND DINK 300	16' - 21'	V-TECH LINE SPORT	5522	540 x 460	-120	4	(*)	
GRAND DINK 300	16' - 21'	V-TECH LINE TOURING	6790	750 x 615	+130	4	(*)	
G-DINK 50	12' - 18'	V-TECH LINE TOURING	6728	700 x 520	+200	4	(*)	
G-DINK 125i	12' - 18'	V-TECH LINE TOURING	6728	700 x 520	+200	4	(*)	
G-DINK 300i	12' - 18'	V-TECH LINE TOURING	6728	700 x 520	+200	4	(*)	
G-DINK 300i	19' - 20'	V-TECH LINE TOURING	9864	750 x 620	+100	4	(*)	
K-XCT 125i	13' - 16'	V-TECH LINE TOURING	6810	790 x 520	+180	4	(*)	
K-XCT 300i	13' - 16'	V-TECH LINE TOURING	6810	790 x 520	+180	4	(*)	
SUPERDINK 125i	09' - 14'	V-TECH LINE SPORT	5522	540 x 460	-120	4	(*)	
SUPERDINK 125i	09' - 14'	V-TECH LINE TOURING	6790	750 x 615	+130	4	(*)	
SUPERDINK 300i	09' - 14'	V-TECH LINE SPORT	5522	540 x 460	-120	4	(*)	
SUPERDINK 300i	09' - 14'	V-TECH LINE TOURING	6790	750 x 615	+130	4	(*)	
SUPERDINK 350i	09' - 14'	V-TECH LINE SPORT	5522	540 x 460	-120	4	(*)	
SUPERDINK 350i	09' - 14'	V-TECH LINE TOURING	6790	750 x 615	+130	4	(*)	
XCITING 400i	17' - 20'	V-TECH LINE TOURING	9864	750 x 620	+100	4	(*)	
XCITING S 400	19' - 21'	V-TECH LINE TOURING	3757	795 x 759	+155	4	(*)	
XCITING 500i	07' - 13'	V-TECH LINE SPORT	5271	605 x 360	+0	4	(*)	
X-TOWN 125	16' - 20'	V-TECH LINE SPORT	5522	540 x 460	-120	4	(*)	
X-TOWN 125	16' - 20'	V-TECH LINE TOURING	6790	750 x 615	+130	4	(*)	
X-TOWN 300	16' - 20'	V-TECH LINE SPORT	5522	540 x 460	-120	4	(*)	
X-TOWN 300	16' - 20'	V-TECH LINE TOURING	6790	750 x 615	+130	4	(*)	
YAGER GT 125i	13' - 18'	V-TECH LINE TOURING	6728	700 x 520	+200	4	(*)	
YAGER GT 300i	13' - 18'	V-TECH LINE TOURING	6728	700 x 520	+200	4	(*)	
MBK								
EVOLIS 125	10' - 20'	V-TECH LINE TOURING	6259	560 x 430	+125	4	(*)	

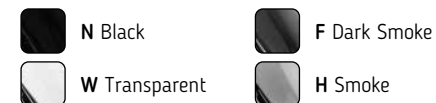

(*) Check price with your distributor.
IMPORTANT: Indicate code color after part#. Example 0973A.

WINDSHIELDS FOR MAXISCOOTERS

HI-TECH PARTS | TYPE OF WINDSCREEN:



Only V-TECH LINE SPORT

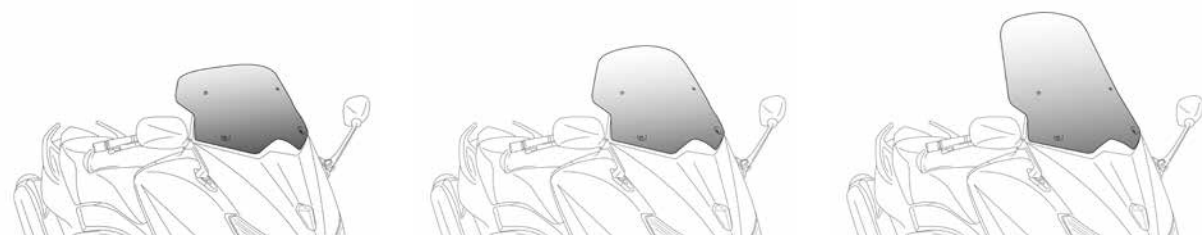

V-TECH LINE SUPERSPORT

V-TECH LINE SPORT

V-TECH LINE TOURING

2022		For the new 2022 motorcycle models check www.puig.tv						
MODEL	YEAR	TYPE OF V-TECH LINE	REF.	DIMENSIONS (Height x Width)	HEIGHT (mm) Compared to OEM	THICKNESS (mm)		
EVOLIS 250	10' - 20'	V-TECH LINE TOURING	6259	560 x 430	+125	4	(*)	
EVOLIS 400	13' - 20'	V-TECH LINE TOURING	6874	660 x 540	+140	4	(*)	
PIAGGIO								
MP3 350	18' - 21'	V-TECH LINE TOURING	1666	825 x 655	+150	4	(*)	
MP3 500 HPE ABS ASR	18' - 21'	V-TECH LINE TOURING	1666	825 x 655	+150	4	(*)	
MP3 500 HPE BUSINESS ABS ASR	18' - 21'	V-TECH LINE TOURING	1666	825 x 655	+150	4	(*)	
SUZUKI								
BURGMAN 400	17' - 21'	V-TECH LINE TOURING	9973	760 x 595	+220	4	(*)	
YAMAHA								
NMAX 125	15' - 20'	V-TECH LINE TOURING	8121	740 x 385	+350	4	(*)	
NMAX 125	21'	V-TECH LINE TOURING	20737	840 x 615	+115	4	(*)	
NMAX 155	21'	V-TECH LINE TOURING	20737	840 x 615	+115	4	(*)	
MAJESTY 125 S	15' - 16'	V-TECH LINE TOURING	7665	605 x 510	+130	4	(*)	
S-MAX	15' - 16'	V-TECH LINE TOURING	7665	605 x 510	+130	4	(*)	
T-MAX 530	12' - 16'	V-TECH LINE SPORT	6036	400 x 350	-90	4	(*)	
T-MAX 530	12' - 16'	V-TECH LINE TOURING	6260	590 x 425	+70	4	(*)	
T-MAX 530	12' - 16'	V-TECH LINE SUPERSPORT	7499	330 x 470	-210	4	(*)	
T-MAX 530/DX/SX	17' - 19'	V-TECH LINE SPORT	9423	335 x 430		4	(*)	
T-MAX 530/DX/SX	17' - 19'	V-TECH LINE TOURING	9424	675 x 555	+115	4	(*)	
T-MAX 530/DX/SX	17' - 19'	V-TECH LINE SUPERSPORT	9841	250 x 220	-200	4	(*)	
T-MAX 560 /SX/DX/MAX TECH	20' - 21'	V-TECH LINE SPORT	9423	335 x 430		4	(*)	
T-MAX 560 /SX/DX/MAX TECH	20' - 21'	V-TECH LINE TOURING	9424	675 x 555	+115	4	(*)	
T-MAX 560 /SX/DX/MAX TECH	20' - 21'	V-TECH LINE SUPERSPORT	9841	250 x 220	-200	4	(*)	
TRICITY 125	15' - 19'	V-TECH LINE TOURING	7666	710 x 520	+415	4	(*)	
X-MAX 125	05' - 09'	V-TECH LINE TOURING	5015	370 x 410	+200	4	(*)	
X-MAX 125	10' - 13'	V-TECH LINE TOURING	6259	560 x 430	+125	4	(*)	
X-MAX 125	14' - 17'	V-TECH LINE TOURING	6874	660 x 540	+140	4	(*)	
X-MAX 125	18' - 21'	V-TECH LINE SPORT	9474	430 x 350	-170	4	(*)	
X-MAX 125	18' - 21'	V-TECH LINE TOURING	9476	715 x 570	+130	4	(*)	

2022		For the new 2022 motorcycle models check www.puig.tv						
MODEL	YEAR	TYPE OF V-TECH LINE	REF.	DIMENSIONS (Height x Width)	HEIGHT (mm) Compared to OEM	THICKNESS (mm)		
X-MAX 250	05' - 09'	V-TECH LINE TOURING	5015	370 x 410	+200	4	(*)	
X-MAX 250	10' - 13'	V-TECH LINE TOURING	6259	560 x 430	+125	4	(*)	
X-MAX 250	14' - 16'	V-TECH LINE TOURING	6874	660 x 540	+140	4	(*)	
X-MAX 300	17' - 21'	V-TECH LINE SPORT	9474	430 x 350	-170	4	(*)	
X-MAX 300	17' - 21'	V-TECH LINE TOURING	9476	715 x 570	+130	4	(*)	
X-MAX 400	13' - 17'	V-TECH LINE TOURING	6874	660 x 540	+140	4	(*)	
X-MAX 400	18' - 21'	V-TECH LINE SPORT	9474	430 x 350	-170	4	(*)	
X-MAX 400	18' - 21'	V-TECH LINE TOURING	9476	715 x 570	+130	4	(*)	

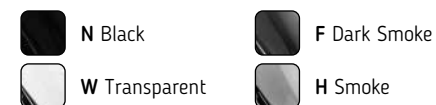

(*) Check price with your distributor.
IMPORTANT: Indicate code color after part#. Example 0973A.

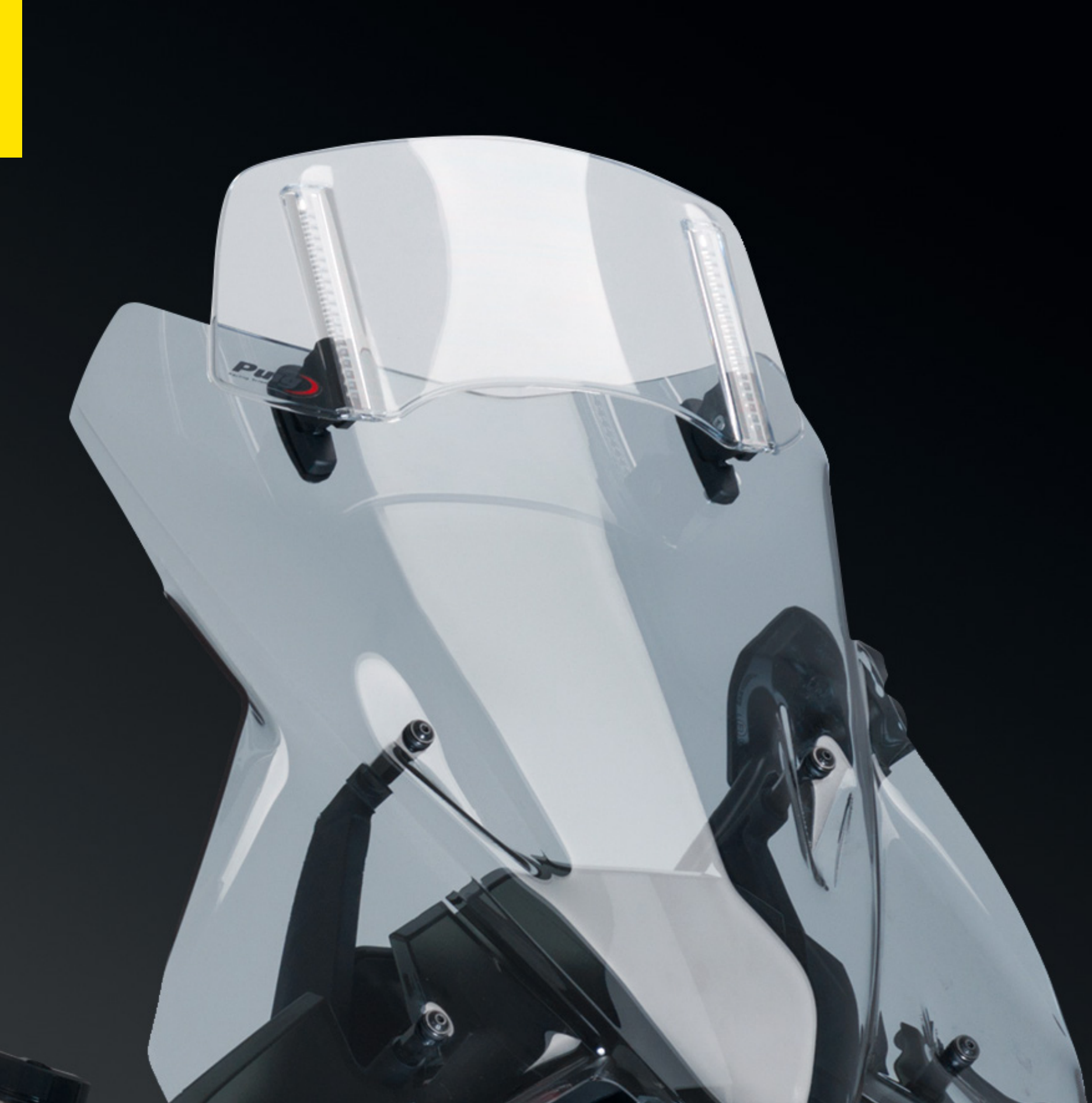

MULTIADJUSTABLE VISORS 2.0. FIXED BY SCREWS

HI-TECH PARTS | TECHNICAL SECTION

Puig
Street Screens

NEW!

VISOR

* Check availability for motorcycle models at www.puig.tv typing in the searching window.

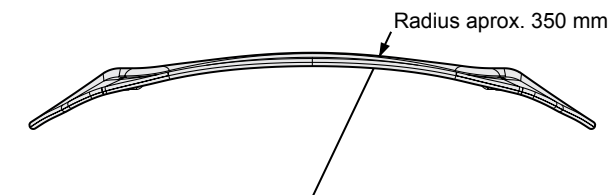
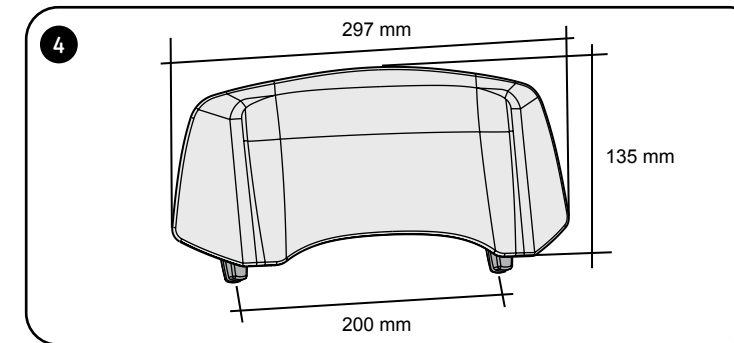

REFERENCE	W	H
20763		(*)

SPARES	REFERENCE	H	W	N
MULTI-ADJUSTABLE MECHANISM BY PAIR	20766N			(*)
VISOR SPARE (325 x 140 mm.)	20765	(*)		

The multi-adjustable bolt-on visors can be mounted on the Puig windscreen as well as on the stock one. The multi-adjustable visors are adjustable on inclination and height.

Check compatibility and references in [our website](#).

H Smoke

W Transparent

(*) Check price with your distributor.

IMPORTANT: Indicate code color after part#. Example 0973A.

ASSEMBLY PROCEDURE

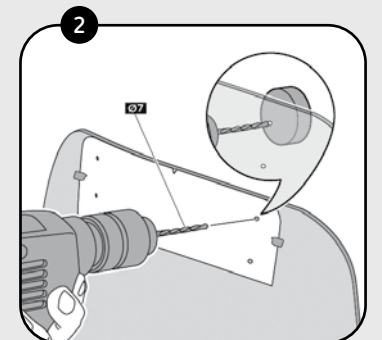
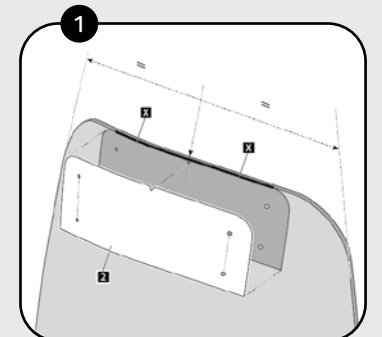

* Template supplied.

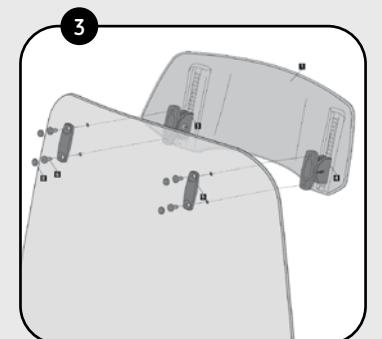

NOTE:
If order "touring with visor" kit, the windscreen will come factory-drilled so no drilling is necessary.



MULTIADJUSTABLE VISORS 2.0. CLIP-ON

HI-TECH PARTS | TECHNICAL SECTION

Puig
Street Screens

NEW!

VISOR

* Check availability for motorcycle models at www.puig.tv typing in the searching window.

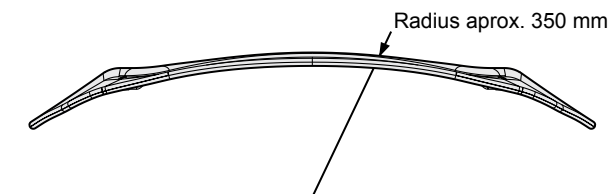
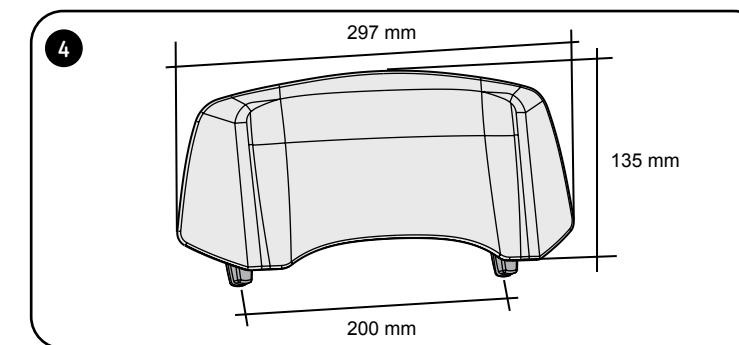

REFERENCE	W	H
20764		(*)

SPARES	REFERENCE	H	W	N
MULTI-ADJUSTABLE MECHANISM BY PAIR	20766N			(*)
VISOR SPARE (325 x 140 mm.)	20765		(*)	

- H Smoke
- W Transparent

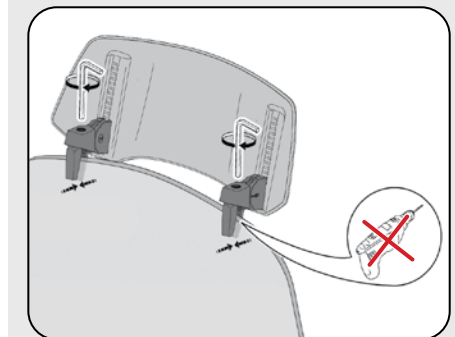

The multi-adjustable clip-on visors can be mounted on the Puig windshield as well as the stock one. The multi-adjustable visors are adjustable on inclination and height.

Check compatibility and references in our **website**.

Suitable screen thicknesses between 3 and 5 mm.

It's not necessary to drill the screen to hold the visor.

(*) Check price with your distributor.
IMPORTANT: Indicate code color after part#. Example 0973A.

MULTIADJUSTABLE VISORS FIXED BY SCREWS

HI-TECH PARTS | TECHNICAL SECTION



* Check availability for motorcycle models at www.puig.tv typing in the searching window.

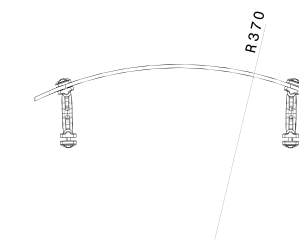
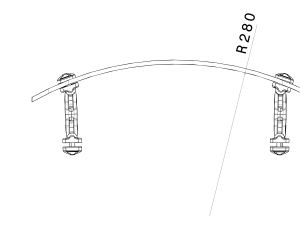
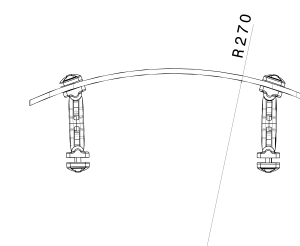
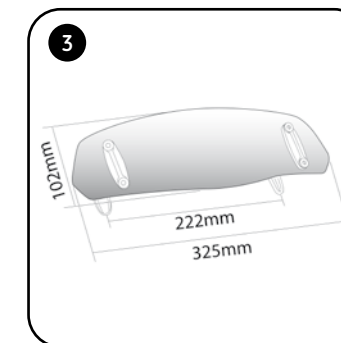
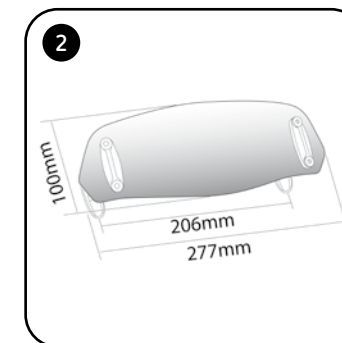
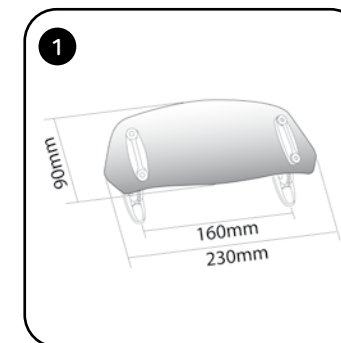
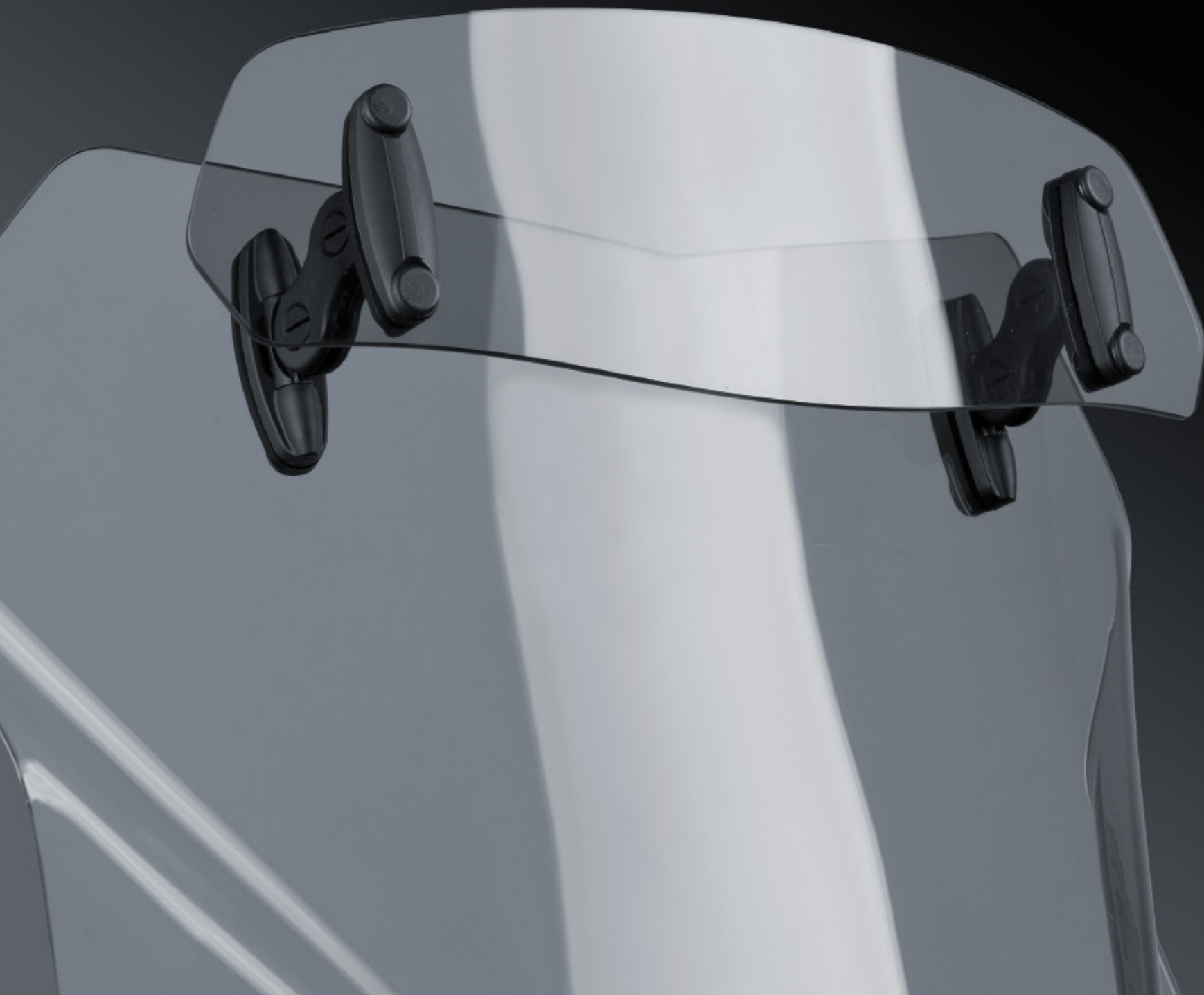

REFERENCE	W	H
6007	(*)	(*)

REFERENCE	W	H
5852	(*)	(*)

REFERENCE	W	H
5853	(*)	(*)

SPARES	REFERENCE	H	W	N
MULTI-ADJUSTABLE MECHANISM BY PAIR	6271			(*)
VISOR SPARE N.1 (230 x 90 mm.)	6268	(*)		
VISOR SPARE N.2 (277 x 100 mm.)	6269	(*)		
VISOR SPARE N.3 (325 x 102 mm.)	6270	(*)		

The multi-adjustable bolt-on visors can be mounted on the Puig windscreen as well as on the stock one. Check compatibility and references in [our website](#).

- H Smoke
- W Transparent

(*) Check price with your distributor.
IMPORTANT: Indicate code color after part#. Example 0973A.

ASSEMBLY PROCEDURE

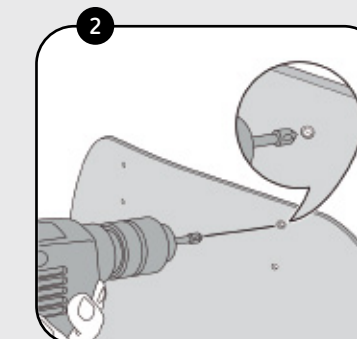
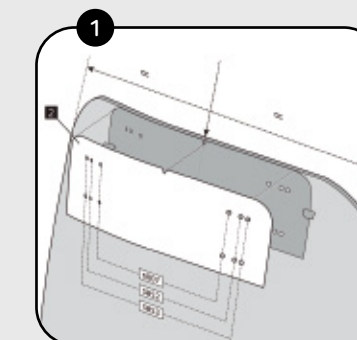

* Template supplied.

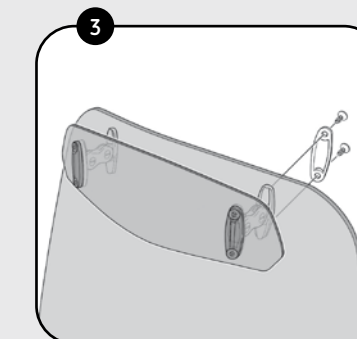

NOTE:
 If order "touring with visor" kit, the windscreen will come factory-drilled so no drilling is necessary.



MULTIADJUSTABLE VISORS CLIP-ON

HI-TECH PARTS | TECHNICAL SECTION



* Check availability for motorcycle models at www.puig.tv typing in the searching window.

1	2	3																		
<table border="1"> <tr> <th>REFERENCE</th> <th>H</th> <th>W</th> </tr> <tr> <td>6319</td> <td></td> <td>(*)</td> </tr> </table>	REFERENCE	H	W	6319		(*)	<table border="1"> <tr> <th>REFERENCE</th> <th>H</th> <th>W</th> </tr> <tr> <td>6320</td> <td></td> <td>(*)</td> </tr> </table>	REFERENCE	H	W	6320		(*)	<table border="1"> <tr> <th>REFERENCE</th> <th>H</th> <th>W</th> </tr> <tr> <td>6375</td> <td></td> <td>(*)</td> </tr> </table>	REFERENCE	H	W	6375		(*)
REFERENCE	H	W																		
6319		(*)																		
REFERENCE	H	W																		
6320		(*)																		
REFERENCE	H	W																		
6375		(*)																		

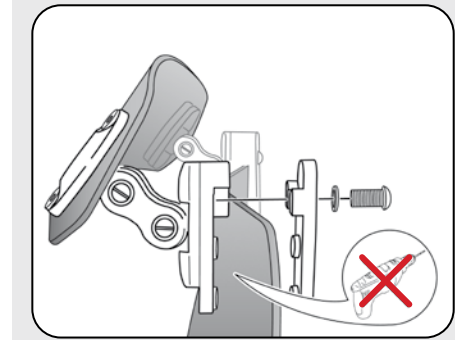

The multi-adjustable clip-on visors can be mounted on the Puig windshield as well as the stock one.

Check compatibility and references in **our website**.

Suitable screen thicknesses between 3 and 5 mm.

It's not necessary to drill the screen to hold the visor.

RECOMMENDATIONS
 REF. 6319 for OEM windshields of 180 mm. minimum width; REF. 6320 for OEM windshields of 226 mm. minimum width; REF. 6375 for OEM windshields of 242 mm. minimum width.

SPARES	REFERENCE	H	W	N
MULTI-ADJUSTABLE MECHANISM BY PAIR	6799			(*)
VISOR SPARE N.1 (230 x 90 mm.)	6871		(*)	
VISOR SPARE N.2 (277 x 100 mm.)	6872		(*)	
VISOR SPARE N.3 (325 x 102 mm.)	6873		(*)	

- H Smoke
- W Transparent

(*) Check price with your distributor.
 IMPORTANT: Indicate code color after part#. Example 0973A.

DEFLECTORS FOR WINDSHIELDS

HI-TECH PARTS | TECHNICAL SECTION



* Check availability for motorcycle models at www.puig.tv typing in the searching window.

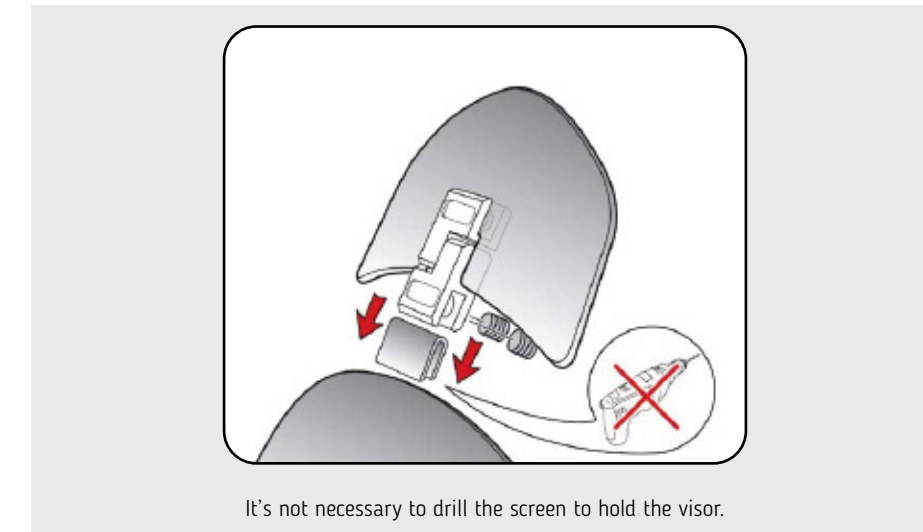

It's not necessary to drill the screen to hold the visor.

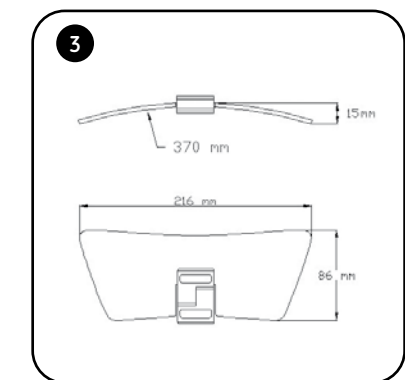
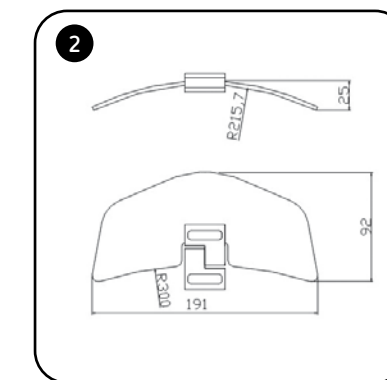
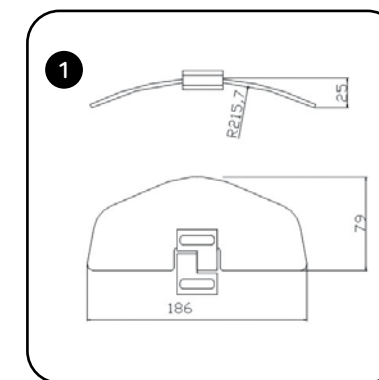

MODEL	REFERENCE	W	H	D
DEFLECTOR 1	4639	(*)	(*)	
DEFLECTOR 2	4717	(*)	(*)	
DEFLECTOR 3	4835	(*)		
METALLIC MECHANISM	6878D			(*)

- W Transparent
- H Smoke
- D Anodized

(*) Check price with your distributor.
IMPORTANT: Indicate code color after part#. Example 0973A.



WINDSHIELD SPECIFIC FOR NON-ROUND HEADLIGHTS

HI-TECH PARTS | TECHNICAL SECTION



VIRTUAL WIND TUNNEL TESTED

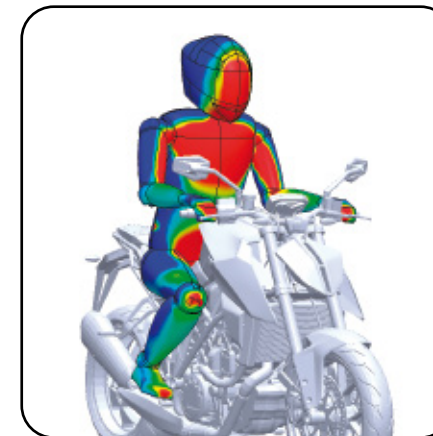

● Lower pressure
● Max. pressure
Wind pressure without
Windshield Naked New
Generation Puig.

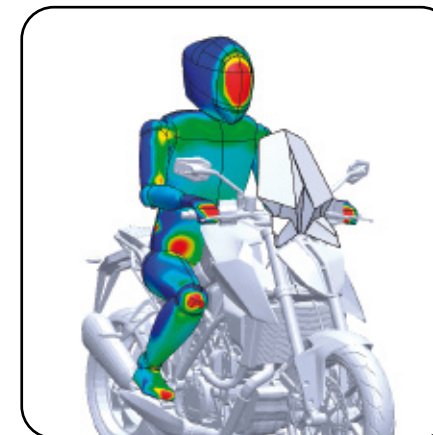

● Lower pressure
● Max. pressure
Wind pressure with
Windshield Naked New
Generation Puig.

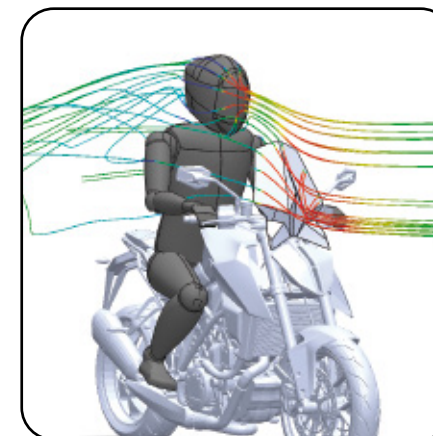

Improve aerodynamics
and windprotection.

At PUIG, depending on the model, we apply a silkscreen or not on our windscreens to hide unattractive parts of the motorcycle.

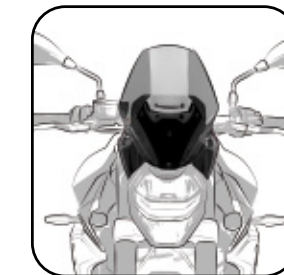

F900R
Serigraphed windshield brilliant
in the interior

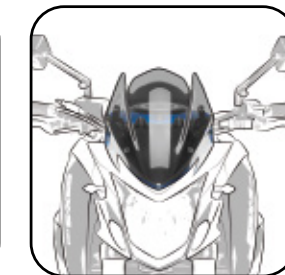

GSX-S750
Windscreen without silkscreened



Z900
Silkscreened windshield in black
matt on the outside



The shape of the windshield may vary according to the motorcycle model. Please visit our website.

WINDSHIELD SPECIFIC FOR NON-ROUND HEADLIGHTS

HI-TECH PARTS | TYPE OF WINDSCREEN:

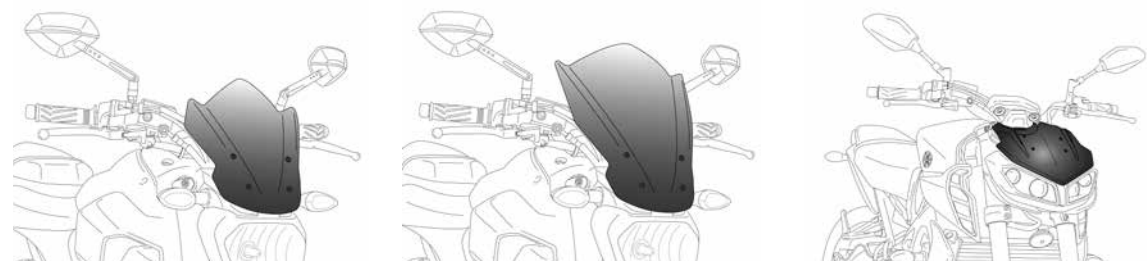

SPORT

TOURING

SPORT PLUS

2022		For the new 2022 motorcycle models check www.puig.tv						
MODEL	YEAR	TYPE	REF.	DIMENSIONS (Height x Width)	HEIGHT (mm) Compared to OEM	THICKNESS (mm)	R T G V A N W H F C	
APRILIA								
DORSODURO 750	08' - 16'	TOURING	4947	330 x 395		3	(*) (*)	
DORSODURO 900	17' - 21'	TOURING	4947	330 x 395		3	(*) (*)	
DORSODURO 1200	11' - 16'	TOURING	4947	330 x 395		3	(*) (*)	
SHIVER 750	07' - 09'	SPORT	3767	305 x 273	+120 to speedometer	3	(*) (*)	
SHIVER 900	17' - 21'	SPORT	3767	305 x 273	+120 to speedometer	3	(*) (*)	
BENELLI								
502C	19' - 21'	SPORT	3690	260 x 240	+125	3	(*) (*)	
BN 752S	18' - 21'	SPORT	20505	267 x 293	+105 to speedometer	3	(*) (*)	
LEONCINO 500	16' - 21'	SPORT	9747	295 x 258	+110	4	(*) (*)	
LEONCINO TRAIL	17' - 21'	SPORT	9747	295 x 258	+110	4	(*) (*)	
BMW								
F800 R	09' - 14'	SPORT	5051 (-)	330 x 310		3	(*) (*)	
F800 R	15' - 20'	SPORT	7650	310 x 240	+140	3	(*) (*)	
F800 R	15' - 20'	TOURING	8187	430 x 350	+265	3	(*) (*)	
F900 R	20' - 21'	SPORT (1)	20359	350 x 225	+140	4	(*) (*)	
F900 R	20' - 21'	SPORT (2)	20360	350 x 225	+140	4	(*) (*)	
F900 R	20' - 21'	TOURING (2)	20361	475 x 320	+260	4	(*) (*)	
F900 R	20' - 21'	TOURING (1)	20362	475 x 320	+260	4	(*) (*)	

2022		For the new 2022 motorcycle models check www.puig.tv						
MODEL	YEAR	TYPE	REF.	DIMENSIONS (Height x Width)	HEIGHT (mm) Compared to OEM	THICKNESS (mm)	R T G V A N W H F C	
G310 R	16' - 21'	SPORT	8920	305 x 275	+160	3	(*) (*)	
K1300 R	09' - 16'	SPORT	4940	390 x 425	+60	3	(*) (*)	
R1200 R	06' - 14'	SPORT	6488	350 x 320	+130	4	(*) (*)	
R1200 R	15' - 18'	SPORT (1)	7651	365 x 300	+95	4	(*) (*)	
R1200 R	15' - 18'	SPORT (2)	8168	370 x 295	+95		(*) (*)	
R1200 R	15' - 18'	TOURING (2)	8110	530 x 360	+250		(*) (*)	
R1200 R	15' - 18'	TOURING (1)	8165	525 x 360	+250	4	(*) (*)	
R1250 R	19' - 21'	SPORT (1)	3623	335 x 300	+195	4	(*) (*)	
R1250 R	19' - 21'	SPORT (2)	3624	335 x 300	+195	4	(*) (*)	
R1250 R	19' - 21'	TOURING (2)	3625	350 x 455	+290	4	(*) (*)	
R1250 R	19' - 21'	TOURING (1)	3626	350 x 455	+290	4	(*) (*)	
R18	20' - 21'	TOURING	20527	630 x 520	+340 to speedometer	4	(*) (*)	
S1000 R	14' - 18'	SPORT	7040	335 x 270	+170	3	(*) (*)	
DUCATI								
DIAVEL	11' - 13'	TOURING	5655 (-)	450 x 355	+65	3	(*) (*)	
DIAVEL	14' - 18'	REGULABLE	7592 (-)	290 x 235	+65	3	(*) (*)	
DIAVEL	14' - 18'	REGULABLE	7570 (-)	445 x 350	+65	3	(*) (*)	
DIAVEL 1260/S	19' - 21'	REGULABLE	3773 (-)				(*) (*)	
DIAVEL 1260/S	19' - 21'	REGULABLE	3775 (-)				(*) (*)	
HYPERMOTARD 950/SP	19' - 21'	SPORT	3634	360 x 288	+230	3	(*) (*)	
HYPERMOTARD 950 RVE	21'	SPORT	3634	360 x 288	+230	3	(*) (*)	
MONSTER 696	08' - 14'	SPORT	4672	245 x 240		3	(*) (*)	
MONSTER 796	10' - 14'	SPORT	4672	245 x 240		3	(*) (*)	
MONSTER 797	17' - 20'	SPORT (3)	7013	260 x 290		3	(*) (*)	
MONSTER 821	14' - 20'	SPORT (3)	7013	260 x 290	+100	3	(*) (*)	
MONSTER 937	21'	SPORT	20712	370 x 255	+200 to handlebar	3	(*) (*)	
MONSTER 1100/S	09' - 10'	SPORT	4672	245 x 240		3	(*) (*)	
MONSTER 1100 EVO	11' - 13'	SPORT	4672	245 x 240		3	(*) (*)	
MONSTER 1200/S	14' - 16'	SPORT (3)	7013	260 x 290	+100	3	(*) (*)	
MONSTER 1200/S	17' - 21'	SPORT (3)	7013	260 x 290	+100	3	(*) (*)	
MONSTER 1200 R	16' - 20'	SPORT (3)	7013	260 x 290	+100	3	(*) (*)	
STREETFIGHTER V4/S	20' - 21'	SPORT	20467	281 x 235	+40 to speedometer	3	(*) (*)	
X DIAVEL/S	16' - 18'	REGULABLE	8921 (-)	295 x 250		3	(*) (*)	
X DIAVEL/S	16' - 18'	REGULABLE	8922 (-)	450 x 355		3	(*) (*)	
HARLEY DAVIDSON								
SPORTSTER 883 IRON	09' - 20'	TOURING	9283	275 x 220		4	(*) (*)	
SPORTSTER 883 LOW	04' - 10'	TOURING	9283	275 x 220		4	(*) (*)	

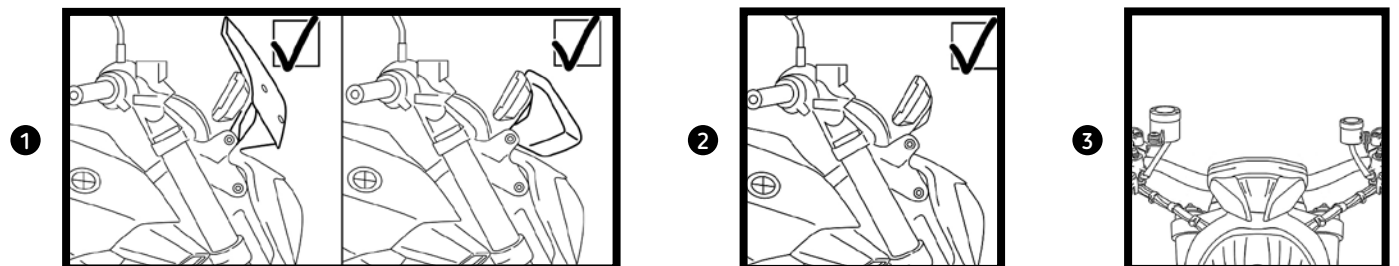

BMW R1200R 15' - 18' / R1250R 19'

REF. 7013

■ R Red ■ V Green ■ W Transparent ■ C Carbon look
■ T Orange ■ A Blue ■ H Smoke
■ G Yellow ■ N Black ■ F Dark Smoke

NOTE COLORS: F AND N COLORS DELIVERED WITHOUT SILK PRINT.
 (-) Adjustable in width and height.
 (*) Check price with your distributor.
 (#) Only compatible with Triumph Boneville Bobber with 41 mm. fork.
 (#) This windshield is not compatible with this model Boneville Bobber Black with 47mm fork.
 IMPORTANT: Indicate code color after part#. Example 0973A.

WINDSHIELD SPECIFIC FOR NON-ROUND HEADLIGHTS

HI-TECH PARTS | TYPE OF WINDSCREEN:

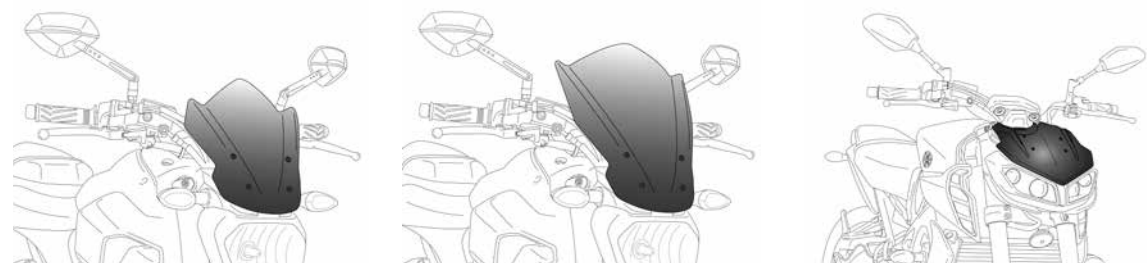

SPORT

TOURING

SPORT PLUS

2022		For the new 2022 motorcycle models check www.puig.tv						
MODEL	YEAR	TYPE	REF.	DIMENSIONS (Height x Width)	HEIGHT (mm) Compared to OEM	THICKNESS (mm)	R T G V A N W H F C	
SPORTSTER 883 SUPERLOW	11' - 20'	TOURING	9283	275 x 220		4	(*)	
SPORTSTER 1200 CUSTOM	04' - 10'	TOURING	9283	275 x 220		4	(*)	
SPORTSTER 1200 CB CUSTOM	13' - 17'	TOURING	9283	275 x 220		4	(*)	
SPORTSTER 1200 IRON	18' - 20'	TOURING	9283	275 x 220		4	(*)	
SPORTSTER 1200 NIGHTSTER	08' - 12'	TOURING	9283	275 x 220		4	(*)	
SPORTSTER 1200 LOW	07' - 09'	TOURING	9283	275 x 220		4	(*)	
SPORTSTER FORTY-EIGHT	10' - 20'	TOURING	9283	275 x 220		4	(*)	
SPORTSTER SEVENTY-TWO	13' - 16'	TOURING	9283	275 x 220		4	(*)	
HONDA								
CB125F	15' - 21'	SPORT	7726	400 x 340	+270	3	(*)	
CB125R NEO SPORTS CAFE	18' - 21'	SPORT	9734	348 x 290	+190	3	(*)	
CB300F	15' - 20'	SPORT	7655	295 x 370		3	(*) (*)	
CB300R NEO SPORTS CAFE	18' - 21'	SPORT	9734	348 x 290	+190	3	(*)	
CB500F	13' - 15'	SPORT	6437	365 x 280	+150	3	(*)	
CB500F	16' - 18'	SPORT	3657	370 x 295		3	(*)	
CB500F	19' - 21'	SPORT	3657	370 x 295		3	(*)	
CB650F	14' - 16'	SPORT	9687	360 x 270	+220	3	(*)	
CB650F	17' - 20'	SPORT	9687	360 x 270		3	(*)	
CB650R NEO SPORTS CAFE	19' - 21'	SPORT	9748	348 x 290	+190	3	(*)	
CB1000R	08' - 10'	SPORT	4673	350 x 340		3	(*) (*)	
CB1000R	11' - 16'	SPORT	5645	350 x 340		3	(*)	
CB1000R NEO SPORTS CAFE	18' - 20'	SPORT	9748	348 x 290	+190	3	(*)	
CB1000R NEO SPORTS CAFE	21'	SPORT	20862				(*)	
CB1000R BLACK EDITION	21'	SPORT	20862				(*)	
CMX 300 REBEL	17' -20'	SPORT	3829	325 x 320	+150 to speedometer	3	(*)	
CMX 300 REBEL	17' -20'	TOURING	9462	420 x 360	+200	4	(*)	
CMX 500 REBEL	17' - 21'	SPORT	3829	325 x 320	+150	3	(*)	
CMX 500 REBEL	17' - 21'	TOURING	9462	420 x 360	+200	4	(*)	
CMX 500 REBEL S	20' - 21'	SPORT	3829	325 x 320	+150	3	(*)	
CMX 500 REBEL S	20' - 21'	TOURING	9462	420 x 360			(*)	

2022		For the new 2022 motorcycle models check www.puig.tv						
MODEL	YEAR	TYPE	REF.	DIMENSIONS (Height x Width)	HEIGHT (mm) Compared to OEM	THICKNESS (mm)	R T G V A N W H F C	
CMX 1100 REBEL	21'	SPORT	20819				(*)	
CMX 1100 REBEL	21'	TOURING	20820				(*)	
CTX700N	14' - 16'	SPORT	7009	400 x 320		4	(*)	
HUSQVARNA								
701 ENDURO	16' - 20'	SPORT	9867	350 x 280	+205	3	(*)	
701 SUPERMOTO	15' - 20'	SPORT	9867	350 x 280	+205	3	(*)	
SVARTPILEN 401	17' - 21'	SPORT	9702	320 x 290	+200	3	(*)	
SVARTPILEN 701	19' - 21'	SPORT	3858	320 x 290	+150	3	(*)	
VITPILEN 401	17' - 21'	SPORT	9702	320 x 290	+200	3	(*)	
VITPILEN 701	17' - 21'	SPORT	9750	320 x 290	+175	3	(*)	
INDIAN								
FTR 1200	19' - 21'	SPORT	3834	335 x 313	+130 to speedometer	4	(*)	
FTR 1200S	19' - 21'	SPORT	3834	335 x 313	+130 to speedometer	4	(*)	
KAWASAKI								
ER-6N	09' - 11'	SPORT	4950	300 x 255		3	(*) (*)	
ER-6N	12' - 16'	SPORT	5997	360 x 330	+95	3	(*) (*)	
VULCAN S	15' - 21'	SPORT	3175	310 x 330	+80	4	(*)	
VULCAN S	15' - 21'	TOURING	8164	470 x 415	+210	4	(*)	
VULCAN S CAFE	17' - 20'	SPORT	3175	310 x 330	+80	4	(*)	
VULCAN S CAFE	17' - 20'	TOURING	8164	470 x 415	+210	4	(*)	
Z125	19' - 21'	SPORT	3494	270 x 240	+90	3	(*)	
Z250SL	15' - 16'	SPORT	7656	360 x 300		3	(*)	
Z300	15' - 17'	SPORT	7657	310 x 305		3	(*) (*)	
Z400	19' - 21'	SPORT	3548	398 x 230	+125	3	(*)	
Z650	17' - 19'	SPORT	9588	340X210		3	(*) (*)	
Z650	17' - 19'	TOURING	9369	460X260		3	(*)	
Z650	20' - 21'	SPORT	3864	330 x 230	+80 to speedometer	3	(*) (*)	
Z650	20' - 21'	TOURING	3865	425 x 300	+180 to speedometer	3	(*)	
Z750	07' - 12'	SPORT	4523	370 x 295			(*)	
Z750R	11' - 12'	SPORT	4523	370 x 295			(*)	
Z800	13' - 16'	SPORT	6401	390 x 270	+200	3	(*) (*)	
Z800E	13' - 16'	SPORT	6401	390 x 270	+200	3	(*) (*)	
Z900	17' - 19'	SPORT	9689	385 x 235		3	(*) (*)	
Z900	17' - 19'	TOURING	9392	395 x 250		3	(*) (*)	
Z900	20' - 21'	SPORT	3840	330 x 230	+70 to speedometer	3	(*) (*)	
Z900	20' - 21'	TOURING	3841	425 x 300	+170 to speedometer	3	(*)	
Z1000	10' - 13'	SPORT	5254	425 x 300		3	(*) (*)	

R Red	V Green	W Transparent	C Carbon look
T Orange	A Blue	H Smoke	
G Yellow	N Black	F Dark Smoke	

NOTE COLORS: F AND N COLORS DELIVERED WITHOUT SILK PRINT.

(-) Adjustable in width and height.
 (*) Check price with your distributor.
 (#) Only compatible with Triumph Boneville Bobber with 41 mm. fork.
 (#) This windshield is not compatible with this model Boneville Bobber Black with 47mm fork.
 IMPORTANT: Indicate code color after part#. Example 0973A.

WINDSHIELD SPECIFIC FOR NON-ROUND HEADLIGHTS

HI-TECH PARTS | TYPE OF WINDSCREEN:

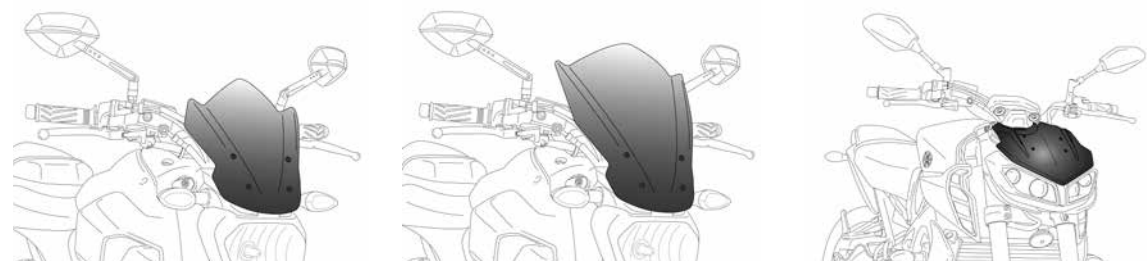

SPORT

TOURING

SPORT PLUS

2022		For the new 2022 motorcycle models check www.puig.tv						
MODEL	YEAR	TYPE	REF.	DIMENSIONS (Height x Width)	HEIGHT (mm) Compared to OEM	THICKNESS (mm)	R T G V A N W H F C	
Z1000	14' - 21'	SPORT	7011	355 x 215	+65	3	(*) (*)	
Z1000	14' - 21'	TOURING	7514	430 x 250	+115	3	(*) (*)	
Z1000R	17' - 21'	SPORT	7011	355 x 215	+65	3	(*) (*)	
Z1000R	17' - 21'	TOURING	7514	430 x 250	+115	3	(*) (*)	
Z H2	20' - 21'	SPORT	20506	330 x 230	+95 to speedometer	3	(*) (*)	
Z H2 SE	20' - 21'	SPORT	20506	330 x 230	+95	3	(*) (*)	
KTM								
125 DUKE	11' - 16'	SPORT	6275	250 x 245		3	(*)	
125 DUKE	17' - 21'	SPORT	9514	415 x 330	+180	3	(*)	
200 DUKE	12' - 15'	SPORT	6275	250 x 245		3	(*)	
390 DUKE	13' - 16'	SPORT	6275	250 x 245		3	(*)	
390 DUKE	17' - 21'	SPORT	9514	415 x 330	+180	3	(*)	
690 DUKE	08' - 11'	SPORT	4941	260 x 275		3	(*)	
690 DUKE	12' - 20'	SPORT	6009	265 x 265	+210	3	(*)	
690 DUKE R	10' - 11'	SPORT	4941	260 x 275		3	(*)	
690 DUKE R	12' - 17'	SPORT	6009	265 x 265		3	(*)	
690 ENDURO R	19' - 21'	SPORT	3586	315 x 295	+190	3	(*)	
690 SMC R	19' - 21'	SPORT	3586	315 x 295	+190	3	(*)	
790 DUKE	18' - 21'	SPORT	9668	415 x 330	+250	3	(*) (*)	
890 DUKE R	20' - 21'	SPORT	9668	415 x 330	+250	3	(*) (*)	
950 SUPERENDURO	06' - 09'	SPORT	5053	310 x 315		3	(*)	
950 SUPERMOTO	05' - 07'	SPORT	5053	310 x 315		3	(*)	
950 SUPERMOTO R	07' - 08'	SPORT	5053	310 x 315		3	(*)	
990 SUPERDUKE	07' - 13'	SPORT	4942	290 x 285		3	(*)	
990 SUPERDUKE R	07' - 13'	SPORT	4942	290 x 285		3	(*)	
990 SUPERMOTO	08' - 13'	SPORT	5173	285 x 295		3	(*)	
990 SUPERMOTO R	09' - 13'	SPORT	5173	285 x 295		3	(*)	
1290 SUPERDUKE R	14' - 16'	SPORT	7014	420 x 315	+115	3	(*) (*)	
1290 SUPERDUKE R	17' - 19'	TOURING	9692	415 x 330	+200	3	(*) (*)	
1290 SUPERDUKE R	20' - 21'	SPORT	20425	265 x 330	+100	3	(*)	

2022		For the new 2022 motorcycle models check www.puig.tv						
MODEL	YEAR	TYPE	REF.	DIMENSIONS (Height x Width)	HEIGHT (mm) Compared to OEM	THICKNESS (mm)	R T G V A N W H F C	
1290 SUPERDUKE R	20' - 21'	TOURING	20461	415X330	+250 to speedometer	3	(*)	
MV AGUSTA								
BRUTALE 1000RR	20' - 21'	SPORT	20680	330 x 230	+150 to speedometer	3	(*)	
RIVALE 800	13' - 18'	SPORT	6499	310 x 315	+170	3	(*)	
SUZUKI								
B-KING	08' - 11'	SPORT	4630	380 x 330		3	(*) (*)	
GSF1250 BANDIT	09' - 11'	SPORT	5027	330 x 390		3	(*)	
GSF1250 BANDIT	10' - 13'	SPORT	5027	330 x 390		3	(*)	
GSR600	06' - 11'	SPORT	4117	340 x 280		3	(*)	
GSR750	11' - 16'	SPORT	5646	320 x 300		3	(*)	
GSX-S125	17' - 21'	SPORT	9873	295 x 250	+100	3	(*)	
GSX-S750	17' - 21'	SPORT	9435	310 x 250		3	(*) (*)	
GSX-S750	17' - 21'	TOURING	9436	440 x 320		3	(*)	
GSX-S1000	15' - 21'	SPORT	7653	320 x 260	+175	3	(*) (*)	
GSX-S1000	22'	TOURING	20835				(*)	
GSX-S1000	22'	SPORT	20833				(*)	
INAZUMA	13' - 17'	SPORT	6251	320 x 260		3	(*)	
SFV650 GLADIUS	09' - 15'	SPORT	4951	300 x 255		3	(*) (*)	
TRIUMPH								
BONNEVILLE BOBBER	17' - 21'	TOURING	9437 (#)	275 x 215	+170	4	(*)	
BONNEVILLE BOBBER BLACK	20' - 21'	TOURING	9437 (#)	275 x 215	+170	4	(*)	
ROCKET 3	20' - 21'	TOURING	20283	375 x 360	+110 to speedometer	4	(*)	
SPEED TRIPLE	05' - 10'	SPORT	3930	280 x 380		3	(*)	
SPEED TRIPLE	11' - 15'	SPORT	5658	355 x 270	+110	3	(*) (*)	
SPEED TRIPLE	16' - 20'	SPORT	8929	320 x 340		3	(*) (*)	
SPEED TRIPLE R	12' - 15'	SPORT	5658	355 x 270		3	(*) (*)	
SPEED TRIPLE R	16' - 18'	SPORT	8929	320 x 340		3	(*) (*)	
SPEED TRIPLE S	19' - 21'	SPORT	8929	320 x 340		3	(*) (*)	
SPEED TRIPLE RS	19' - 20'	SPORT	8929	320 x 340		3	(*) (*)	
SPEED TRIPLE RS	21'	SPORT	20795				(*)	
STREET TRIPLE	07' - 10'	SPORT	3930	280 x 380		3	(*)	
STREET TRIPLE	13' - 16'	SPORT	5658	355 x 270		3	(*) (*)	
STREET TRIPLE	17' - 20'	SPORT	8929	320 x 340		3	(*) (*)	
STREET TRIPLE R	08' - 10'	SPORT	3930	280 x 380		3	(*)	
STREET TRIPLE R	13' - 15'	SPORT	5658	355 x 270		3	(*) (*)	
STREET TRIPLE R	17' - 19'	SPORT	8929	320 x 340		3	(*) (*)	
STREET TRIPLE R	20' - 21'	SPORT	20432	310 x 330	+150	3	(*)	

■ R Red ■ V Green ■ W Transparent ■ C Carbon look
■ T Orange ■ A Blue ■ H Smoke
■ G Yellow ■ N Black ■ F Dark Smoke

NOTE COLORS: F AND N COLORS DELIVERED WITHOUT SILK PRINT.
 (-) Adjustable in width and height.
 (*) Check price with your distributor.
 (#) Only compatible with Triumph Bonneville Bobber with 41 mm. fork.
 (fork) This windshield is not compatible with this model Bonneville Bobber Black with 47mm fork.
 IMPORTANT: Indicate code color after part#. Example 0973A.

WINDSHIELD SPECIFIC FOR NON-ROUND HEADLIGHTS

HI-TECH PARTS | TYPE OF WINDSCREEN:

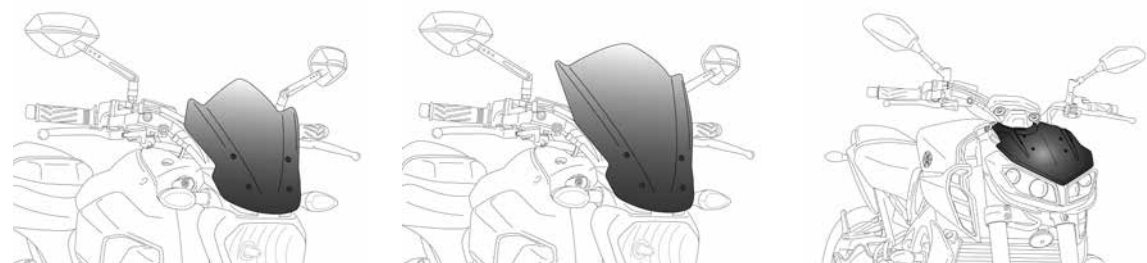

SPORT

TOURING

SPORT PLUS

2022		For the new 2022 motorcycle models check www.puig.tv						
MODEL	YEAR	TYPE	REF.	DIMENSIONS (Height x Width)	HEIGHT (mm) Compared to OEM	THICKNESS (mm)	R T G V A N W H F C	
STREET TRIPLE RS	17' - 19'	SPORT	8929	320 x 340		3	(*) (*)	
STREET TRIPLE RS	20' - 21'	SPORT	20432	310 x 330	+150	3	(*) (*)	
STREET TRIPLE S	17' - 19'	SPORT	9999	310 x 330	+120	3	(*) (*)	
STREET TRIPLE S	20' - 21'	SPORT	20432	310 x 330	+150	3	(*) (*)	
TRIDENT 660	21'	SPORT	20638	320 x 285	+145 to speedometer	3	(*) (*)	
YAMAHA								
FZ1	06' - 15'	SPORT	4119	320 x 330		3	(*) (*)	
FZ8	10' - 16'	SPORT	5872	300 x 290		3	(*) (*)	
MT-125	14' - 19'	SPORT	7654	320 x 260		3	(*) (*)	
MT-125	20' - 21'	SPORT	3879	303 x 270	+70	4	(*) (*)	
MT-03	16' - 19'	TOURING	8932	330 x 280	+170	3	(*) (*)	
MT-03	20' - 21'	SPORT	20285	303 x 270	+70	4	(*) (*)	
MT-07	14' - 17'	SPORT	7015	295 x 250	+180	3	(*) (*)	
MT-07	14' - 17'	TOURING	7016	380 x 300	+260	3	(*) (*)	
MT-07	18' - 20'	SPORT	9666	230 x 235	+100	3	(*) (*)	
MT-07	18' - 20'	TOURING	9667	360 x 288	+230	3	(*) (*)	
MT-07	18' - 20'	SPORTPLUS	1439	220 x 235			(*) (*)	
MT-07	21'	SPORT	20618	320 x 235	+60 to speedometer	3	(*) (*)	
MT-07	21'	TOURING	20619	445 x 310	+155 to speedometer	3	(*) (*)	
MT-07	21'	SPORTPLUS	20620	260 x 235	-20 to speedometer	3	(*) (*)	
MT-09	13' - 16'	SPORT	6859	290 x 300		3	(*) (*)	
MT-09	13' - 16'	TOURING	6861	350 x 290	+60	3	(*) (*)	
MT-09	17' - 20'	SPORT	9376	290 x 270		3	(*) (*)	
MT-09	17' - 20'	TOURING	9377	426 x 300		3	(*) (*)	
MT-09	17' - 20'	SPORTPLUS	9507			3	(*) (*)	
MT-09	21'	SPORT	20644	325 x 260	+115 to handlebar	3	(*) (*)	
MT-09	21'	TOURING	20645	455 x 315	+220 to handlebar	3	(*) (*)	
MT-09	21'	SPORTPLUS	20643				(*) (*)	
MT-09 SP	18' - 20'	SPORT	9376	290 x 270		3	(*) (*)	
MT-09 SP	18' - 20'	TOURING	9377	426 x 300		3	(*) (*)	

2022		For the new 2022 motorcycle models check www.puig.tv						
MODEL	YEAR	TYPE	REF.	DIMENSIONS (Height x Width)	HEIGHT (mm) Compared to OEM	THICKNESS (mm)	R T G V A N W H F C	
MT-09 SP	18' - 20'	SPORTPLUS	9507			3	(*) (*)	
MT-09 SP	21'	SPORT	20644	325 x 260	+115	3	(*) (*)	
MT-09 SP	21'	TOURING	20645	455 x 315	+220	3	(*) (*)	
MT-09 SP	21'	SPORTPLUS	20643				(*) (*)	
VMAX	09' - 20'	SPORT	4952	420 x 480		3	(*) (*)	
XJ6	09' - 16'	SPORT	5026	325 x 270		3	(*) (*)	
XV950	14' - 21'	TOURING	9438	480 x 350	+240	4	(*) (*)	
XV950R	14' - 21'	TOURING	9438	480 x 350	+240	4	(*) (*)	
XV950 RACER	14' - 21'	TOURING	9438	480 x 350	+240	4	(*) (*)	

■ R Red ■ V Green ■ W Transparent
■ T Orange ■ A Blue ■ H Smoke
■ G Yellow ■ N Black ■ F Dark Smoke



NOTE COLORS: F AND N COLORS DELIVERED WITHOUT SILK PRINT.

(-) Adjustable in width and height.
 (*) Check price with your distributor.
 (#) Only compatible with Triumph Bonneville Bobber with 41 mm. fork.
 This windshield is not compatible with this model Bonneville Bobber Black with 47mm fork.
 IMPORTANT: Indicate code color after part#. Example 0973A.

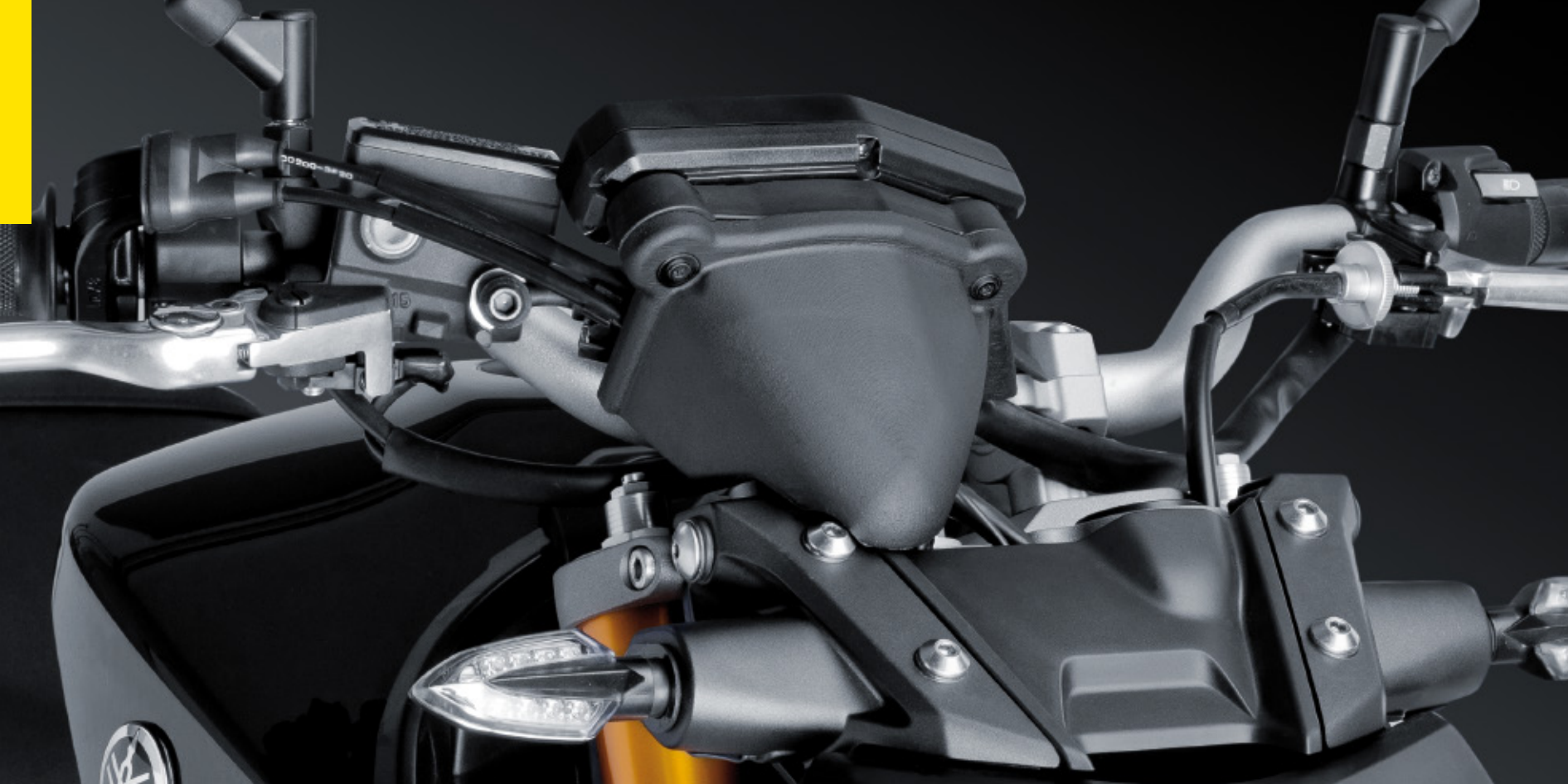

CLOCK TOPS

HI-TECH PARTS | TECHNICAL SECTION

MODEL	YEAR	REF.	J	C
YAMAHA				
MT-09	13' - 16'	7515	(*)	(*)

- J Matt black
- C Carbon look

REF. 7515



(*) Check price with your distributor.
IMPORTANT: Indicate code color after part#. Example 0973A.

FRONTAL DEFLECTORS SCREENS

HI-TECH PARTS | TECHNICAL SECTION

MODEL	YEAR	REF.	F	H	N	W
HONDA						
CRF1100L AFRICA TWIN ADVENTURE SPORTS	20' - 21'	3823			(*)	
YAMAHA						
MT-07 TRACER	16' - 18'	9226			(*)	
MT-07 TRACER GT	19'	9226			(*)	
MT-09 TRACER	15' - 17'	9225			(*)	

- N Black
- W Transparent
- H Smoke
- F Dark Smoke

REF. 9225



(*) Check price with your distributor.
IMPORTANT: Indicate code color after part#. Example 0973A.

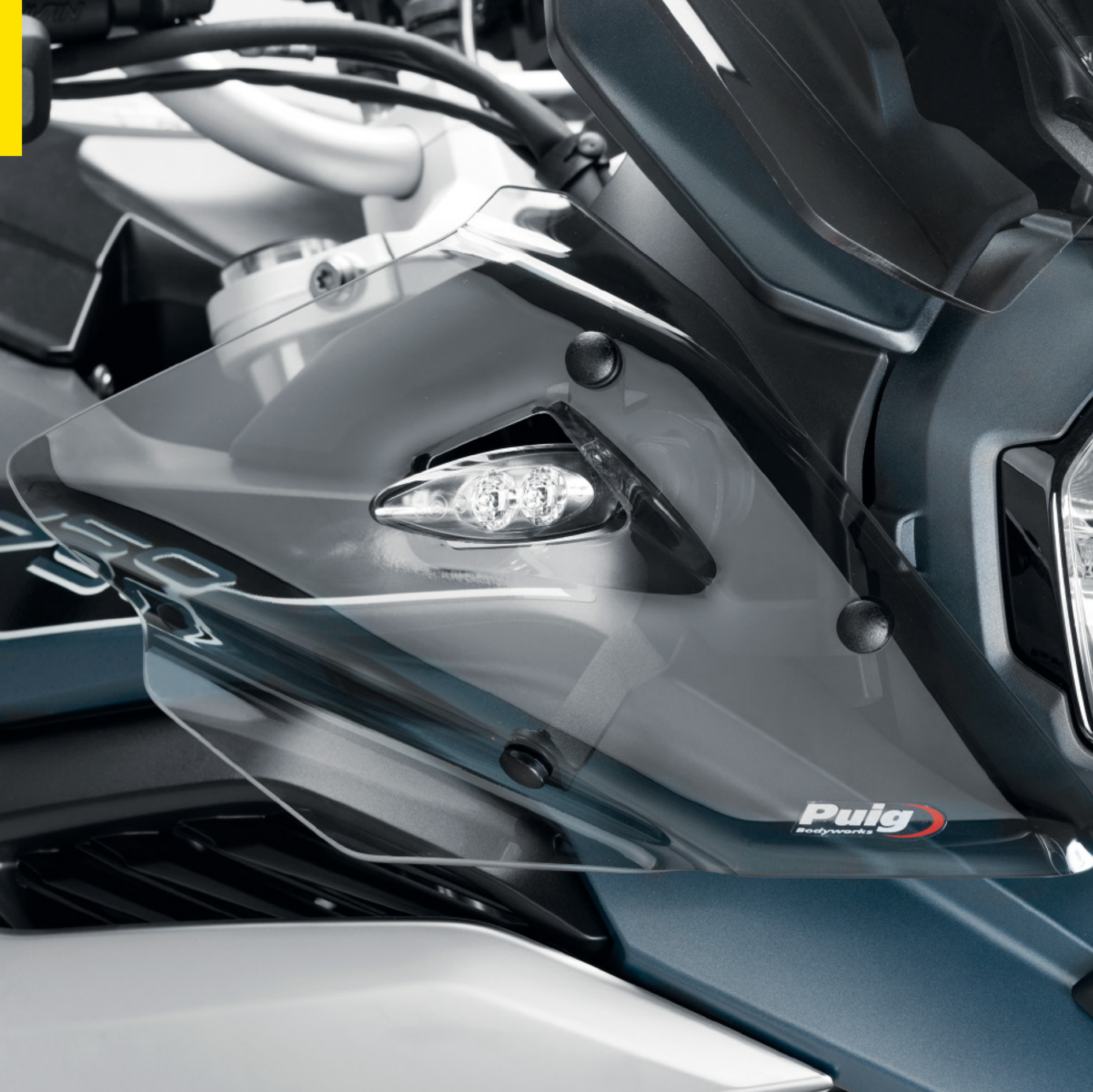

UPPER DEFLECTORS

HI-TECH PARTS | TECHNICAL SECTION



REF. 9847



Puig
DEFLECTORS

OEM
WITHOUT DEFLECTOR



- W Transparent
- H Smoke
- F Dark Smoke

MODEL	YEAR	REF.	F H W
BMW			
F750GS	18' - 21'	9847	(*)
F850GS	18' - 21'	9847	(*)
F850GS ADVENTURE	19'	9847	(*)
F900XR	20' - 21'	20430	(*)
R1200GS	13' - 18'	9847	(*)
R1200GS EXCLUSIVE	17' - 18'	9847	(*)
R1200GS RALLYE	17' - 18'	9847	(*)
R1250GS	18' - 21'	9847	(*)
KTM			
1090 ADVENTURE/R	17' - 20'	9623	(*)
1290 SUPER ADVENTURE R/S	17' - 20'	9623	(*)
1290 SUPER ADVENTURE T	17'	9623	(*)
TRIUMPH			
TIGER 900	20' - 21'	20420	(*)
TIGER 900 GT	20' - 21'	20420	(*)
TIGER 900 GT LOW	20' - 21'	20420	(*)
TIGER 900 GT PRO	20' - 21'	20420	(*)

(*) Check price with your distributor.
IMPORTANT: Indicate code color after part#. Example 0973A.



NEW!

MITO

MODEL	REF.	N	H	F	W
MITO UNIVERSAL HANDLEBARS 22/29	20702				(*)

-  N Black
-  H Smoke
-  W Transparent
-  F Dark Smoke

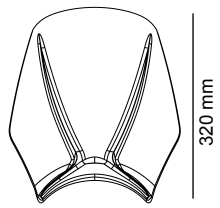

285 mm
320 mm
2 FIXATION POINTS



* Check availability for motorcycle models at www.puig.tv typing in the searching window.



FLANKER



MODEL	REF.	N	H	F	W
FLANKER UNIVERSAL HANDLEBARS 22/29	20334				(*)

-  N Black
-  H Smoke
-  W Transparent
-  F Dark Smoke

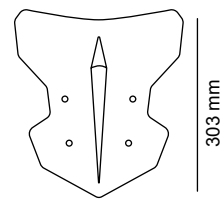

270 mm
303 mm
2 FIXATION POINTS



* Check availability for motorcycle models at www.puig.tv typing in the searching window.



BAT



MODEL	REF.	H F W
BAT UNIVERSAL HANDLEBARS 22/29	8088	(*)

- H Smoke
- F Dark Smoke
- W Transparent

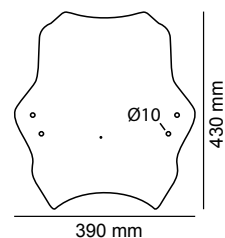

2 FIXATION POINTS



* Check availability for motorcycle models at www.puig.tv typing in the searching window.



RAFALE



MODEL	REF.	R T G V A N H F W
RAFALE UNIVERSAL HANDLEBARS 22/29	5881	(*)

- R Red
- T Orange
- G Yellow
- V Green
- A Blue
- N Black
- W Transparent
- H Smoke
- F Dark Smoke

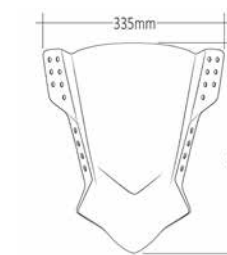

2 FIXATION POINTS



* Check availability for motorcycle models at www.puig.tv typing in the searching window.

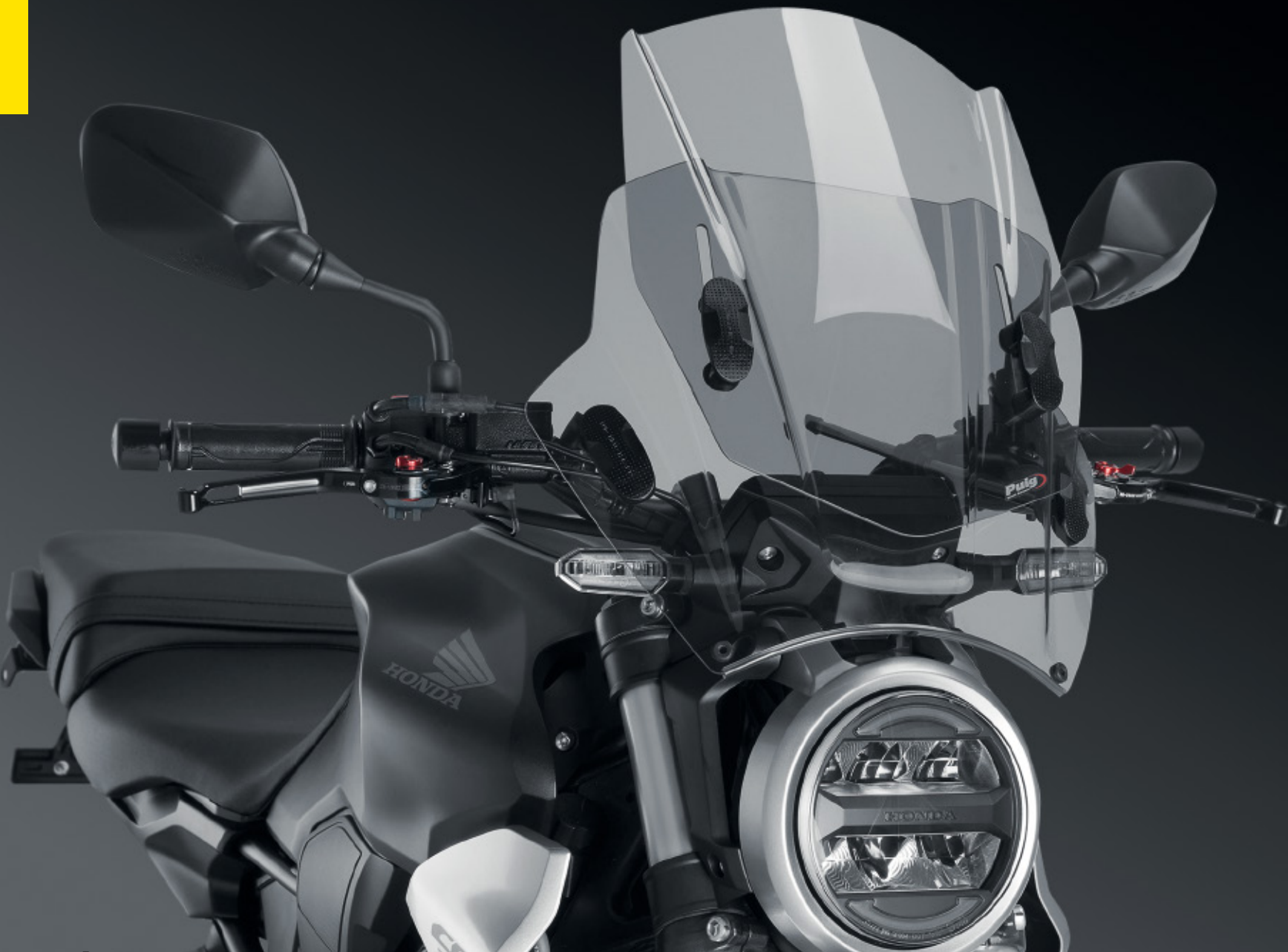

UP&DOWN



MODEL	REF.	F W
UP&DOWN UNIVERSAL HANDLEBARS 22/29	2193	(*)

- F Dark Smoke
- W Transparent

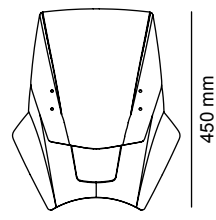

410 mm
450 mm
2 FIXATION POINTS



* Check availability for motorcycle models at www.puig.tv typing in the searching window.



TREND



MODEL	REF.	A N H F
TREND UNIVERSAL HANDLEBARS 22/29	5022	(*)

- A Blue
- N Black
- H Smoke
- F Dark Smoke

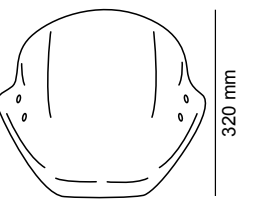

410 mm
320 mm
2 FIXATION POINTS



* Check availability for motorcycle models at www.puig.tv typing in the searching window.



TREND WITH VISOR



MODEL	REF.	H
TREND WITH VISOR UNIVERSAL HANDLEBARS 22/29	5920	(*)



H Smoke

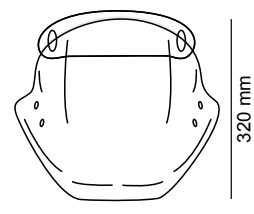

410 mm

320 mm

2 FIXATION POINTS



* Check availability for motorcycle models at www.puig.tv typing in the searching window.



TOURING II



MODEL	REF.	W	H
TOURING II UNIVERSAL HANDLEBARS 22/29	5267	(*)	(*)



H Smoke



W Transparent

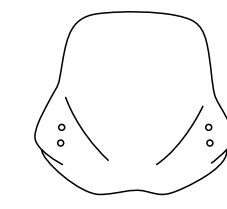

535 mm

480 mm

2 FIXATION POINTS



* Check availability for motorcycle models at www.puig.tv typing in the searching window.



SEMI-FAIRINGS

HI-TECH PARTS | TECHNICAL SECTION



AERODYNAMIC TEST

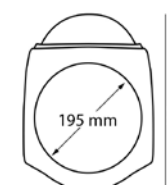

300 mm
2 FIXATION POINTS

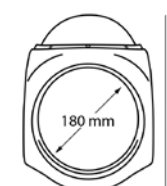

280 mm
2 FIXATION POINTS

 C Carbon look

 J Matt black



BMW R NINE T
(REF. 9160F)

MODEL	REF.	F	H	N	W
UNIVERSAL BLACK SEMI-FAIRING Ø 195 mm.	9553				(*)
UNIVERSAL CARBON LOOK SEMI-FAIRING Ø 195 mm.	9515				(*)
UNIVERSAL BLACK SEMI-FAIRING Ø 180 mm.	9554				(*)
UNIVERSAL CARBON LOOK SEMI-FAIRING Ø 180 mm.	9516				(*)

SPARES	REF.	F	H	N	W	J	C
SEMI-FAIRING Ø 195 mm.	9230					(*)	(*)
SEMI-FAIRING Ø 180 mm.	9231					(*)	(*)
SCREEN Ø 195 mm.	9196			(*)			
SCREEN Ø 180 mm.	9872			(*)			
UNIVERSAL SUPPORTS SEMI-FAIRING Ø 195 mm.	9978N			(*)			
UNIVERSAL SUPPORTS SEMI-FAIRING Ø 180 mm.	9979N			(*)			

FOR SPECIFIC MODELS SEE PAGE 156.

(*) Check price with your distributor.

IMPORTANT: Indicate code color after part#. Example 0973A.



RETROVISIONS

HI-TECH PARTS | TECHNICAL SECTION



AERODYNAMIC TEST

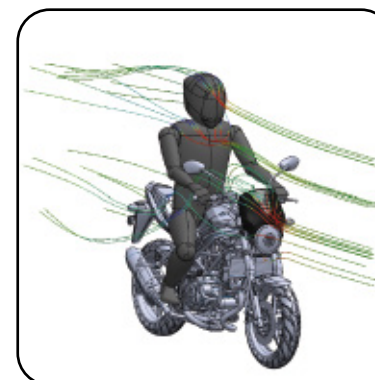

The retrovison is formed by a opaque base (black or carbon look) an a screen light, smoke,dark smoke, black or clear.

-  C Carbon look
-  J Matt black



DUCATI SCRAMBLER
(REF. 7652)

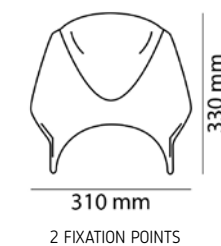

MODEL	REF.
UNIVERSAL RETROVISION (#)	SEE PAGE 170

SPARES	REF.	F H N W
SCREEN	1517	(*)

FOR SPECIFIC MODELS SEE PAGE 156.
(#) ADHESIVE KIT INCLUDED.

(*) Check price with your distributor.
IMPORTANT: Indicate code color after part#. Example 0973A.



FRONTAL PLATE (IN ALUMINIUM)

HI-TECH PARTS | TECHNICAL SECTION



AERODYNAMIC TEST



May be used as small screen for wind protection or as a number plate.

Look at adhesive numbers on page 163.

It carries a set of universal supports or specific supports for selected models.



REF. 9807N

-  P Aluminium
-  N Black



REF. 9807P

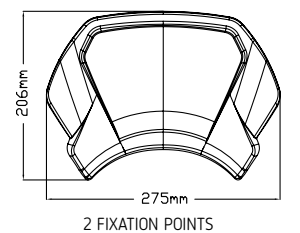

MODEL	REF.	P	N
UNIVERSAL FRONT PLATE - FIXING TO FORKS	3592	(*)	(*)
UNIVERSAL FRONT PLATE - FIXING TO SUPPORTS OF THE FARE	3593	(*)	(*)

SPARES	REF.	P	N
ALUMINIUM FRONTAL PLATE	9807	(*)	(*)
UNIVERSAL SUPPORTS	9977	(*)	(*)

FOR SPECIFIC MODELS SEE PAGE 156.
ADHESIVE NUMBER SEE PAGE 163.

(*) Check price with your distributor.

IMPORTANT: Indicate code color after part#. Example 0973A.



FRONTAL PLATE (IN ABS)

HI-TECH PARTS | TECHNICAL SECTION



AERODYNAMIC TEST



Double function: Deflects wind and number plate.

Available with universal supports or specific for selected motorcycles.

FRONTAL PLATE

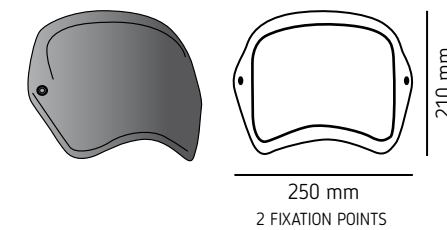

ASYMETRIC FRONTAL PLATE

(Only REF. 9177, 9522)

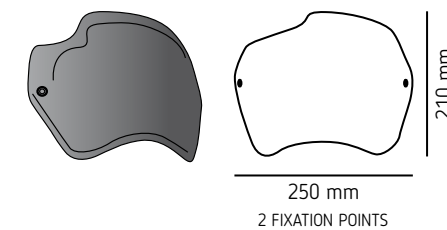

C Carbon look

J Matt black



REF. 9229C

MODEL	REF.	J	C
UNIVERSAL FRONT PLATE - FIXING TO FORKS	3590	(*)	(*)
UNIVERSAL FRONTAL PLATE - FIXING TO THE LIGHT SUPPORT	3591	(*)	(*)

SPARES	REF.	J	C	N
FRONTAL PLATE	9229	(*)	(*)	
FRONTAL PLATE ASYMMETRIC	20299	(*)	(*)	
UNIVERSAL SUPPORTS	9977			(*)

FOR SPECIFIC MODELS SEE PAGE 156.
ADHESIVE NUMBER SEE PAGE 163.

(*) Check price with your distributor.

IMPORTANT: Indicate code color after part#. Example 0973A.

RETROVISIONS | FRONTAL PLATES | SEMI-FAIRING

HI-TECH PARTS



SEMI-FAIRING

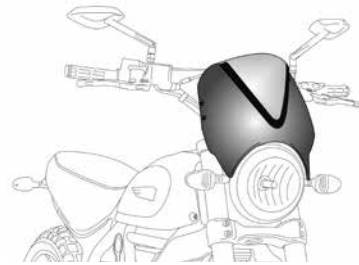

RETROVISIONS

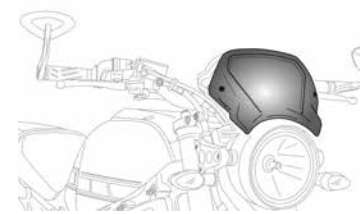

ALUMINIUM FRONTAL PLATE



ABS FRONTAL PLATE

2022		For the new 2022 motorcycle models check www.puig.tv						
MODEL	YEAR	TYPE	COLOR	REF.	F H N W	J	C	P
BMW								
R NINE T	14' - 21'	RETROVISION	MATT BLACK	7012	(*)			
R NINE T	14' - 21'	RETROVISION	CARBON LOOK	7559	(*)			
R NINE T	14' - 21'	ABS FRONTAL PLATE		9167		(*)	(*)	
R NINE T	14' - 21'	ALUMINIUM FRONTAL PLATE		9798	(*)			(*)
R NINE T	14' - 21'	SEMI-FAIRING	MATT BLACK	9160	(*)			
R NINE T	14' - 21'	SEMI-FAIRING	CARBON LOOK	9178	(*)			
R NINE T SCRAMBLER	16' - 20'	RETROVISION	MATT BLACK	9338	(*)			
R NINE T SCRAMBLER	16' - 20'	RETROVISION	CARBON LOOK	9339	(*)			
R NINE T SCRAMBLER	16' - 20'	ABS FRONTAL PLATE		9252		(*)	(*)	
R NINE T SCRAMBLER	16' - 20'	ALUMINIUM FRONTAL PLATE		9797	(*)			(*)
R NINE T SCRAMBLER	16' - 20'	SEMI-FAIRING	MATT BLACK	9253	(*)			
R NINE T SCRAMBLER	16' - 20'	SEMI-FAIRING	CARBON LOOK	9254	(*)			
R NINE T SCRAMBLER	21'	RETROVISION	MATT BLACK	7012	(*)			
R NINE T SCRAMBLER	21'	RETROVISION	CARBON LOOK	7559	(*)			
R NINE T SCRAMBLER	21'	ABS FRONTAL PLATE		9167		(*)	(*)	
R NINE T SCRAMBLER	21'	ALUMINIUM FRONTAL PLATE		9798	(*)			(*)
R NINE T SCRAMBLER	21'	SEMI-FAIRING	MATT BLACK	9160	(*)			
R NINE T URBAN G/S	21'	RETROVISION	MATT BLACK	7012	(*)			
R NINE T URBAN G/S	21'	RETROVISION	CARBON LOOK	7559	(*)			
R NINE T URBAN G/S	21'	ABS FRONTAL PLATE		9167		(*)	(*)	
R NINE T URBAN G/S	21'	ALUMINIUM FRONTAL PLATE		9798	(*)			(*)
R NINE T URBAN G/S	21'	SEMI-FAIRING	MATT BLACK	9160	(*)			
R NINE T PURE	17' - 21'	RETROVISION	MATT BLACK	7012	(*)			
R NINE T PURE	17' - 21'	RETROVISION	CARBON LOOK	7559	(*)			
R NINE T PURE	17' - 21'	ABS FRONTAL PLATE		9167		(*)	(*)	
R NINE T PURE	17' - 21'	ALUMINIUM FRONTAL PLATE		9798	(*)			(*)
R NINE T PURE	21'	SEMI-FAIRING	MATT BLACK	9160	(*)			
BRIXTON								
CROSSFIRE 500		ABS FRONTAL PLATE		3591		(*)	(*)	

2022		For the new 2022 motorcycle models check www.puig.tv						
MODEL	YEAR	TYPE	COLOR	REF.	F H N W	J	C	P
CROSSFIRE 500		ALUMINIUM FRONTAL PLATE		3593	(*)			(*)
CROSSFIRE 500X		ABS FRONTAL PLATE		3591		(*)	(*)	
CROSSFIRE 500X		ALUMINIUM FRONTAL PLATE		3593	(*)			(*)
DUCATI								
SCRAMBLER 800 ICON DARK	20' - 21'	ABS FRONTAL PLATE ASYMETRIC		9177		(*)	(*)	
SCRAMBLER 800 ICON DARK	20' - 21'	ALUMINIUM FRONTAL PLATE		9799	(*)			(*)
SCRAMBLER 800 ICON DARK	20' - 21'	RETROVISION	MATT BLACK	7652	(*)			
SCRAMBLER 800 ICON DARK	20' - 21'	RETROVISION	CARBON LOOK	8192	(*)			
SCRAMBLER 1100	18' - 21'	ASYMETRIC ABS FRONTAL PLATE		9522		(*)	(*)	
SCRAMBLER 1100	18' - 21'	ALUMINIUM FRONTAL PLATE		9800	(*)			(*)
SCRAMBLER 1100	18' - 21'	RETROVISION	CARBON LOOK	8192	(*)			
SCRAMBLER 1100 DARK PRO	21'	ASYMETRIC ABS FRONTAL PLATE		9522		(*)	(*)	
SCRAMBLER 1100 DARK PRO	21'	ALUMINIUM FRONTAL PLATE		9800	(*)			(*)
SCRAMBLER 1100 DARK PRO	21'	RETROVISION	CARBON LOOK	8192	(*)			
SCRAMBLER 1100 SPORT	18' - 21'	ASYMETRIC ABS FRONTAL PLATE		9522		(*)	(*)	
SCRAMBLER 1100 SPORT	18' - 21'	ALUMINIUM FRONTAL PLATE		9800	(*)			(*)
SCRAMBLER 1100 SPORT	18' - 21'	RETROVISION	CARBON LOOK	8192	(*)			
SCRAMBLER 1100 SPECIAL	18' - 21'	ASYMETRIC ABS FRONTAL PLATE		9522		(*)	(*)	
SCRAMBLER 1100 SPECIAL	18' - 21'	ALUMINIUM FRONTAL PLATE		9800	(*)			(*)
SCRAMBLER 1100 SPECIAL	19' - 21'	RETROVISION	CARBON LOOK	8192	(*)			
SCRAMBLER CAFE RACER	17' - 21'	ASYMETRIC ABS FRONTAL PLATE		9177		(*)	(*)	
SCRAMBLER CAFE RACER	17' - 21'	ALUMINIUM FRONTAL PLATE		9799	(*)			(*)
SCRAMBLER DESERT SLED	17' - 21'	RETROVISION	MATT BLACK	7652	(*)			
SCRAMBLER DESERT SLED	17' - 21'	RETROVISION	CARBON LOOK	8192	(*)			
SCRAMBLER DESERT SLED	17' - 21'	ASYMETRIC ABS FRONTAL PLATE		9522		(*)	(*)	
SCRAMBLER DESERT SLED	17' - 21'	ALUMINIUM FRONTAL PLATE		9800	(*)			(*)
SCRAMBLER FLAT TRACK PRO	16'	RETROVISION	MATT BLACK	7652	(*)			
SCRAMBLER FLAT TRACK PRO	16'	RETROVISION	CARBON LOOK	8192	(*)			
SCRAMBLER FLAT TRACK PRO	16'	ABS FRONTAL PLATE ASYMETRIC		9177		(*)	(*)	
SCRAMBLER FLAT TRACK PRO	16'	ALUMINIUM FRONTAL PLATE		9799	(*)			(*)
SCRAMBLER ICON/CLASSIC/FULL THROTTLE	15' - 21'	RETROVISION	MATT BLACK	7652	(*)			
SCRAMBLER ICON/CLASSIC/FULL THROTTLE	15' - 21'	RETROVISION	CARBON LOOK	8192	(*)			
SCRAMBLER ICON/CLASSIC/FULL THROTTLE	15' - 21'	ABS FRONTAL PLATE ASYMETRIC		9177		(*)	(*)	
SCRAMBLER ICON/CLASSIC/FULL THROTTLE	15' - 21'	ALUMINIUM FRONTAL PLATE		9799	(*)			(*)
SCRAMBLER SIXTY2	16' - 21'	RETROVISION	MATT BLACK	7652	(*)			
SCRAMBLER SIXTY2	16' - 21'	RETROVISION	CARBON LOOK	8192	(*)			
SCRAMBLER URBAN ENDURO	15' - 16'	RETROVISION	MATT BLACK	7652	(*)			
SCRAMBLER URBAN ENDURO	15' - 16'	RETROVISION	CARBON LOOK	8192	(*)			
SCRAMBLER URBAN ENDURO	15' - 16'	ABS FRONTAL PLATE ASYMETRIC		9177		(*)	(*)	

J Matt black
 P Aluminium
 W Transparent
 F Dark Smoke

 H Smoke
 N Black
 C Carbon look

(*) Check price with your distributor.
IMPORTANT: Indicate code color after part#. Example 0973A.

RETROVISIONS | FRONTAL PLATES | SEMI-FAIRING

HI-TECH PARTS



SEMI-FAIRING

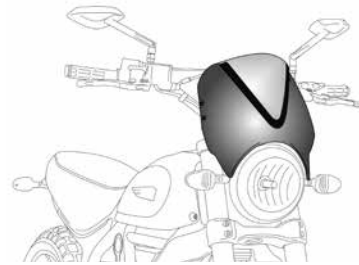

RETROVISIONS

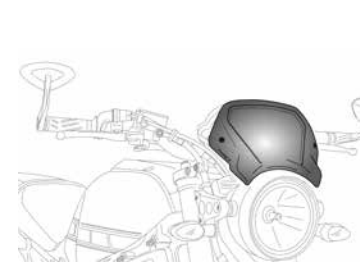

ALUMINIUM FRONTAL PLATE

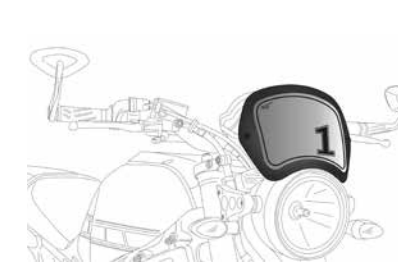

ABS FRONTAL PLATE

2022		For the new 2022 motorcycle models check www.puig.tv						
MODEL	YEAR	TYPE	COLOR	REF.	F H N W	J	C	P
SCRAMBLER URBAN ENDURO	15' - 16'	ALUMINIUM FRONTAL PLATE		9799	(*)			(*)
HARLEY DAVIDSON								
SPORTSTER 883 IRON	09' - 20'	ABS FRONTAL PLATE		1351		(*)	(*)	
SPORTSTER 883 IRON	09' - 20'	ALUMINIUM FRONTAL PLATE		1352	(*)			(*)
SPORTSTER FORTY-EIGHT 48	17' - 20'	ABS FRONTAL PLATE		20399		(*)	(*)	
SPORTSTER FORTY-EIGHT 48	17' - 20'	ALUMINIUM FRONTAL PLATE		20400	(*)			(*)
HONDA								
CB125R NEO SPORTS CAFE	18' - 21'	ABS FRONTAL PLATE		9663		(*)	(*)	
CB125R NEO SPORTS CAFE	18' - 21'	ALUMINIUM FRONTAL PLATE		9802	(*)			(*)
CB300R NEO SPORTS CAFE	18' - 21'	ABS FRONTAL PLATE		9663		(*)	(*)	
CB300R NEO SPORTS CAFE	18' - 21'	ALUMINIUM FRONTAL PLATE		9802	(*)			(*)
CB650R NEO SPORTS CAFÉ	19' - 21'	ABS FRONTAL PLATE		9768		(*)	(*)	
CB650R NEO SPORTS CAFÉ	19' - 21'	ALUMINIUM FRONTAL PLATE		9803	(*)			(*)
CB650R NEO SPORTS CAFÉ	19' - 21'	SEMI-FAIRING	MATT BLACK	3133	(*)			
CB650R NEO SPORTS CAFÉ	19' - 21'	SEMI-FAIRING	CARBON LOOK	3143	(*)			
CB1000R NEO SPORTS CAFE	18' - 20'	ABS FRONTAL PLATE		9768		(*)	(*)	
CB1000R NEO SPORTS CAFE	18' - 20'	ALUMINIUM FRONTAL PLATE		9803	(*)			(*)
CB1000R NEO SPORTS CAFE	18' - 20'	SEMI-FAIRING	MATT BLACK	3133	(*)			
CB1000R NEO SPORTS CAFE	18' - 20'	SEMI-FAIRING	CARBON LOOK	3143	(*)			
CB1000R NEO SPORTS CAFE	21'	ABS FRONTAL PLATE		20863		(*)	(*)	
CB1000R NEO SPORTS CAFE	21'	ALUMINIUM FRONTAL PLATE		20864	(*)			(*)
CB1000R BLACK EDITION	21'	ABS FRONTAL PLATE		20863		(*)	(*)	
CB1000R BLACK EDITION	21'	ALUMINIUM FRONTAL PLATE		20864	(*)			(*)
CB1100	13' - 14'	RETROVISION	CARBON LOOK	7594				
CB1100	13' - 14'	SEMI-FAIRING	MATT BLACK	9553	(*)			
CB1100	13' - 14'	SEMI-FAIRING	CARBON LOOK	9515	(*)			
CB1100 EX	14' - 21'	SEMI-FAIRING	MATT BLACK	9553	(*)			
CB1100 EX	14' - 21'	SEMI-FAIRING	CARBON LOOK	9515	(*)			
CB1100 EX	14' - 21'	ABS FRONTAL PLATE		3591		(*)	(*)	
CB1100 EX	14' - 21'	ALUMINIUM FRONTAL PLATE		3593	(*)			(*)

2022		For the new 2022 motorcycle models check www.puig.tv						
MODEL	YEAR	TYPE	COLOR	REF.	F H N W	J	C	P
CB1100 RS	17' - 21'	ABS FRONTAL PLATE		3591		(*)	(*)	
CB1100 RS	17' - 21'	ALUMINIUM FRONTAL PLATE		3593	(*)			(*)
CB1100 RS	17' - 21'	SEMI-FAIRING	MATT BLACK	9553	(*)			
CB1100 RS	17' - 21'	SEMI-FAIRING	CARBON LOOK	9515	(*)			
CMX 300 REBEL	17' - 20'	ABS FRONTAL PLATE		3702		(*)	(*)	
CMX 300 REBEL	17' - 20'	ALUMINIUM FRONTAL PLATE		3701	(*)			(*)
CMX 500 REBEL	17' - 21'	ABS FRONTAL PLATE		3702		(*)	(*)	
CMX 500 REBEL	17' - 21'	ALUMINIUM FRONTAL PLATE		3701	(*)			(*)
CMX 500 REBEL S	20' - 21'	ABS FRONTAL PLATE		3702		(*)	(*)	
CMX 500 REBEL S	20' - 21'	ALUMINIUM FRONTAL PLATE		3701	(*)			(*)
CMX 1100 REBEL	21'	ABS FRONTAL PLATE		20821		(*)	(*)	
CMX 1100 REBEL	21'	ALUMINIUM FRONTAL PLATE		20822	(*)			(*)
MONKEY 125	19' - 21'	ABS FRONTAL PLATE		3504		(*)	(*)	
MONKEY 125	19' - 21'	ALUMINIUM FRONTAL PLATE		3505	(*)			(*)
HUSQVARNA								
VITPILEN 701	17' - 21'	ABS FRONTAL PLATE		3590		(*)	(*)	
VITPILEN 701	17' - 21'	ALUMINIUM FRONTAL PLATE		3592	(*)			(*)
HYOSUNG								
AQUILA GV 125S	19' - 20'	ABS FRONTAL PLATE		3590		(*)	(*)	
AQUILA GV 125S	19' - 20'	ALUMINIUM FRONTAL PLATE		3592	(*)			(*)
INDIAN								
FTR 1200/S	19' - 21'	ABS FRONTAL PLATE		3591		(*)	(*)	
FTR 1200/S	19' - 21'	ALUMINIUM FRONTAL PLATE		3593	(*)			(*)
SCOUT BOBBER	18' - 21'	ABS FRONTAL PLATE		3590		(*)	(*)	
SCOUT BOBBER	18' - 21'	ALUMINIUM FRONTAL PLATE		3592	(*)			(*)
KAWASAKI								
VULCAN S	15' - 21'	ABS FRONTAL PLATE		3590		(*)	(*)	
VULCAN S	15' - 21'	ALUMINIUM FRONTAL PLATE		3592	(*)			(*)
VULCAN S CAFE	17' - 20'	ABS FRONTAL PLATE		3590		(*)	(*)	
VULCAN S CAFE	17' - 20'	ALUMINIUM FRONTAL PLATE		3592	(*)			(*)
Z900RS	18' - 21'	SEMI-FAIRING	MATT BLACK	9595	(*)			
Z900RS	18' - 21'	SEMI-FAIRING	CARBON LOOK	9596	(*)			
MASH								
BLACK SEVEN		ABS FRONTAL PLATE		3591		(*)	(*)	
BLACK SEVEN		ALUMINIUM FRONTAL PLATE		3593	(*)			(*)
BLACK SEVEN		SEMI-FAIRING	MATT BLACK	9553	(*)			
BLACK SEVEN		SEMI-FAIRING	CARBON LOOK	9515	(*)			
MOTO GUZZI								
V7 III STONE	17' - 21'	ABS FRONTAL PLATE		3591		(*)	(*)	

J Matt black
 P Aluminium
 W Transparent
 F Dark Smoke
 H Smoke
 N Black
 C Carbon look

(*) Check price with your distributor.
IMPORTANT: Indicate code color after part#. Example 0973A.

RETROVISIONS | FRONTAL PLATES | SEMI-FAIRING

HI-TECH PARTS



SEMI-FAIRING

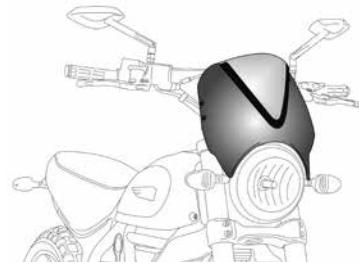

RETROVISIONS

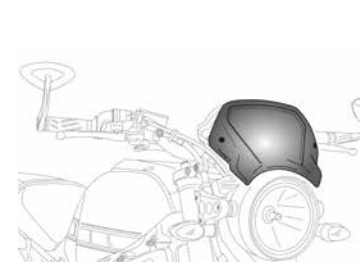

ALUMINIUM FRONTAL PLATE

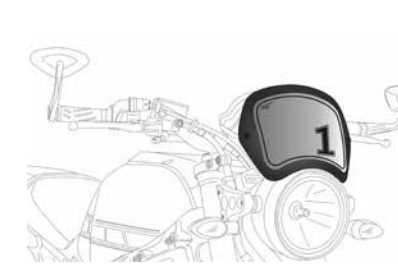

ABS FRONTAL PLATE

2022		For the new 2022 motorcycle models check www.puig.tv						
MODEL	YEAR	TYPE	COLOR	REF.	F H N W	J	C	P
V7 III STONE	17' - 21'	ALUMINIUM FRONTAL PLATE		3593	(*)			(*)
V7 III STONE	17' - 21'	SEMI-FAIRING	MATT BLACK	9554	(*)			
V7 III STONE	17' - 21'	SEMI-FAIRING	CARBON LOOK	9516	(*)			
ROYAL ENFIELD								
INTERCEPTOR 650		ABS FRONTAL PLATE		3591		(*)	(*)	
INTERCEPTOR 650		ALUMINIUM FRONTAL PLATE		3593	(*)			(*)
INTERCEPTOR 650		SEMI-FAIRING	MATT BLACK	9554	(*)			
INTERCEPTOR 650		SEMI-FAIRING	CARBON LOOK	9516	(*)			
SUZUKI								
SV650	16' - 21'	RETROVISION	MATT BLACK	8926	(*)			
SV650	16' - 21'	RETROVISION	CARBON LOOK	8927	(*)			
SV650	16' - 21'	SEMI-FAIRING	MATT BLACK	3169	(*)			
SV650	16' - 21'	SEMI-FAIRING	CARBON LOOK	3170	(*)			
SV650	16' - 21'	ABS FRONTAL PLATE		3590		(*)	(*)	
SV650	16' - 21'	ALUMINIUM FRONTAL PLATE		3592	(*)			(*)
TRIUMPH								
BONNEVILLE SPEEDMASTER	18' - 21'	ABS FRONTAL PLATE		3590		(*)	(*)	
BONNEVILLE SPEEDMASTER	18' - 21'	ALUMINIUM FRONTAL PLATE		3592	(*)			(*)
BONNEVILLE SPEEDMASTER	18' - 21'	SEMI-FAIRING	MATT BLACK	9554	(*)			
BONNEVILLE SPEEDMASTER	18' - 21'	SEMI-FAIRING	CARBON LOOK	9516	(*)			
BONNEVILLE T100	16' - 18'	ABS FRONTAL PLATE		9191		(*)	(*)	
BONNEVILLE T100	16' - 18'	ALUMINIUM FRONTAL PLATE		9808	(*)			(*)
BONNEVILLE T100	16' - 18'	SEMI-FAIRING	MATT BLACK	9176				
BONNEVILLE T100	16' - 18'	SEMI-FAIRING	CARBON LOOK	9195				
BONNEVILLE T120	16' - 19'	ABS FRONTAL PLATE		9191		(*)	(*)	
BONNEVILLE T120	16' - 19'	ALUMINIUM FRONTAL PLATE		9808	(*)			(*)
BONNEVILLE T120	16' - 19'	SEMI-FAIRING	MATT BLACK	9176				
BONNEVILLE T120	16' - 19'	SEMI-FAIRING	CARBON LOOK	9195				
SCRAMBLER 1200XC	19' - 21'	ABS FRONTAL PLATE		3590		(*)	(*)	
SCRAMBLER 1200XC	19' - 21'	ALUMINIUM FRONTAL PLATE		3592	(*)			(*)

2022		For the new 2022 motorcycle models check www.puig.tv						
MODEL	YEAR	TYPE	COLOR	REF.	F H N W	J	C	P
SCRAMBLER 1200XE	19' - 21'	ABS FRONTAL PLATE		3590		(*)	(*)	
SCRAMBLER 1200XE	19' - 21'	ALUMINIUM FRONTAL PLATE		3592	(*)			(*)
SPEED TWIN	19' - 21'	ABS FRONTAL PLATE		3591		(*)	(*)	
SPEED TWIN	19' - 21'	ALUMINIUM FRONTAL PLATE		3593	(*)			(*)
SPEED TWIN	19' - 21'	SEMI-FAIRING	MATT BLACK	9553	(*)			
SPEED TWIN	19' - 21'	SEMI-FAIRING	CARBON LOOK	9515	(*)			
STREET TWIN	16' - 21'	SEMI-FAIRING	MATT BLACK	9553	(*)			
STREET TWIN	16' - 21'	SEMI-FAIRING	CARBON LOOK	9515	(*)			
THRUXTON 1200/R	16' - 20'	SEMI-FAIRING	MATT BLACK	9553	(*)			
THRUXTON 1200/R	16' - 20'	SEMI-FAIRING	CARBON LOOK	9515	(*)			
VOGE								
300AC	21'	ABS FRONTAL PLATE		3590		(*)	(*)	
300AC	21'	ALUMINIUM FRONTAL PLATE		3592	(*)			(*)
YAMAHA								
SCR950	17' - 21'	ABS FRONTAL PLATE		3590		(*)	(*)	
SCR950	17' - 21'	ALUMINIUM FRONTAL PLATE		3592	(*)			(*)
XSR 125	21'	ABS FRONTAL PLATE		3591		(*)	(*)	
XSR 125	21'	ALUMINIUM FRONTAL PLATE		3593	(*)			(*)
XSR 125	21'	SEMI-FAIRING	MATT BLACK	9554	(*)			
XSR 125	21'	SEMI-FAIRING	CARBON LOOK	9516	(*)			
XSR700	16' - 21'	RETROVISION	MATT BLACK	9560	(*)			
XSR700	16' - 21'	RETROVISION	CARBON LOOK	9561	(*)			
XSR700	16' - 21'	SEMI-FAIRING	MATT BLACK	8933	(*)			
XSR700	16' - 21'	SEMI-FAIRING	CARBON LOOK	9187	(*)			
XSR700	16' - 21'	ABS FRONTAL PLATE		3591		(*)	(*)	
XSR700	16' - 21'	ALUMINIUM FRONTAL PLATE		3593	(*)			(*)
XSR700 XTRIBUTE	19' - 20'	RETROVISION	MATT BLACK	9560	(*)			
XSR700 XTRIBUTE	19' - 20'	RETROVISION	CARBON LOOK	9561	(*)			
XSR700 XTRIBUTE	19' - 20'	SEMI-FAIRING	MATT BLACK	8933	(*)			
XSR700 XTRIBUTE	19' - 20'	SEMI-FAIRING	CARBON LOOK	9187	(*)			
XSR700 XTRIBUTE	19' - 21'	ABS FRONTAL PLATE		3591		(*)	(*)	
XSR700 XTRIBUTE	19' - 21'	ALUMINIUM FRONTAL PLATE		3593	(*)			(*)
XSR900	16' - 21'	RETROVISION	MATT BLACK	9560	(*)			
XSR900	16' - 21'	RETROVISION	CARBON LOOK	9561	(*)			
XSR900	16' - 21'	SEMI-FAIRING	MATT BLACK	8934	(*)			
XSR900	16' - 21'	SEMI-FAIRING	CARBON LOOK	9188	(*)			
XSR900	16' - 21'	ABS FRONTAL PLATE		9168		(*)	(*)	
XSR900	16' - 21'	ALUMINIUM FRONTAL PLATE		9806	(*)			(*)
XV950	14' - 21'	ABS FRONTAL PLATE		3812		(*)	(*)	

J Matt black
 P Aluminium
 W Transparent
 F Dark Smoke

H Smoke
 N Black
 C Carbon look

(*) Check price with your distributor.
 IMPORTANT: Indicate code color after part#. Example 0973A.

RETROVISIONS | FRONTAL PLATES | SEMI-FAIRING

HI-TECH PARTS



SEMI-FAIRING

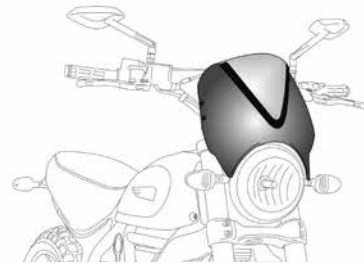

RETROVISIONS

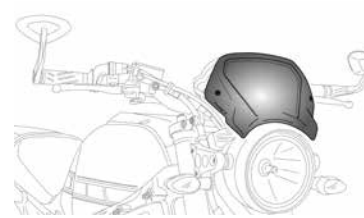

ALUMINIUM FRONTAL PLATE



ABS FRONTAL PLATE

2022		For the new 2022 motorcycle models check www.puig.tv						
MODEL	YEAR	TYPE	COLOR	REF.	F H N W	J	C	P
XV950	14' - 21'	ALUMINIUM FRONTAL PLATE		3813	(*)			(*)
XV950R	14' - 21'	ABS FRONTAL PLATE		3812		(*)	(*)	
XV950R	14' - 21'	ALUMINIUM FRONTAL PLATE		3813	(*)			(*)
XV950 RACER	14' - 21'	ABS FRONTAL PLATE		3812		(*)	(*)	
XV950 RACER	14' - 21'	ALUMINIUM FRONTAL PLATE		3813	(*)			(*)



(*) Check price with your distributor.
IMPORTANT: Indicate code color after part#. Example 0973A.

NUMBERS

HI-TECH PARTS | TECHNICAL SECTION



MODEL	PACK	REF.	R V A N B G P
0	5 UNITS	4263	(*)
1	5 UNITS	4254	(*)
2	5 UNITS	4255	(*)
3	5 UNITS	4256	(*)
4	5 UNITS	4257	(*)
5	5 UNITS	4258	(*)
6	5 UNITS	4259	(*)
7	5 UNITS	4260	(*)
8	5 UNITS	4261	(*)
9	5 UNITS	4262	(*)
DISPLAY		2562N	(*)

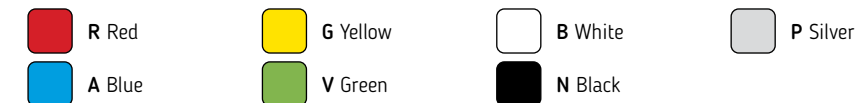

(*) Check price with your distributor.
IMPORTANT: Indicate code color after part#. Example 0973A.



NAKED

TÜV ABE 38188

MODEL	REF.	A	N	H	F
UNIVERSAL	0869				(*)

OPTIMUM MOUNTING FOR HEADLIGHTS Ø 200 mm.



* Check availability for motorcycle models at www.puig.tv typing in the searching window.

- A Blue
- N Black
- H Smoke
- F Dark Smoke

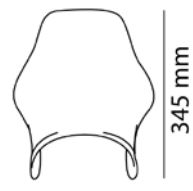

320 mm

345 mm

2 FIXATION POINTS

RAPTOR

TÜV ABE 38188

MODEL	REF.	R	A	N	H	W	F
UNIVERSAL	0013						(*)

OPTIMUM MOUNTING FOR HEADLIGHTS Ø 200 mm.



* Check availability for motorcycle models at www.puig.tv typing in the searching window.

- R Red
- A Blue
- N Black
- H Smoke
- W Transparent
- F Dark Smoke

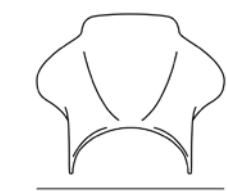

355 mm

295 mm

2 FIXATION POINTS



COCKPIT

TÜV ABE 38188

- R Red
- G Yellow
- A Blue
- N Black
- H Smoke
- W Transparent
- F Dark Smoke

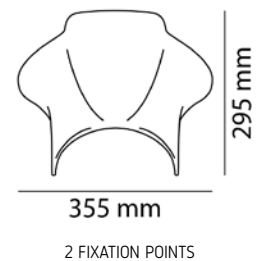

MODEL	REF.	R	G	A	N	H	W	F
UNIVERSAL	1480	*	*	*	*	*	*	*

OPTIMUM MOUNTING FOR HEADLIGHTS Ø 200 mm.



COCKPIT

* Check availability for motorcycle models at www.puig.tv typing in the searching window.



WAVE

TÜV ABE 38188

- R Red
- A Blue
- N Black
- H Smoke
- F Dark Smoke

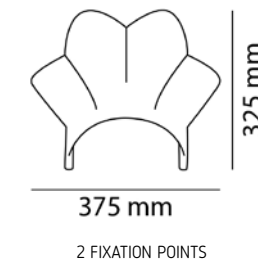

MODEL	REF.	R	A	N	H	F
UNIVERSAL	2208	*	*	*	*	*

OPTIMUM MOUNTING FOR HEADLIGHTS Ø 200 mm.



WAVE

* Check availability for motorcycle models at www.puig.tv typing in the searching window.



TRACK



- R Red
- G Yellow
- A Blue
- N Black
- H Smoke
- Y Iridium
- F Dark Smoke

MODEL	REF.	R	G	A	N	H	F	Y
UNIVERSAL	4120							

OPTIMUM MOUNTING FOR HEADLIGHTS Ø 200 mm.



* Check availability for motorcycle models at www.puig.tv typing in the searching window.

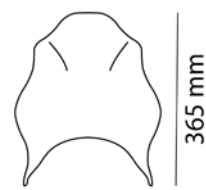

310 mm

365 mm

2 FIXATION POINTS



WINDY



- R Red
- A Blue
- N Black
- W Transparent
- H Smoke
- F Dark Smoke

MODEL	REF.	R	A	N	H	W	F
UNIVERSAL	1482						

OPTIMUM MOUNTING FOR HEADLIGHTS Ø 200 mm.



* Check availability for motorcycle models at www.puig.tv typing in the searching window.

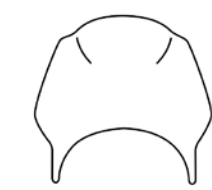

355 mm

315 mm











2 FIXATION POINTS



VISION

TÜV ABE 38188

MODEL	REF.	A N H F W
UNIVERSAL	003CX	(*)
UNIVERSAL	003NX	(*)

-  CA Blue
-  NA Blue
-  CN Black
-  NN Black
-  CH Smoke
-  NH Smoke
-  CF Dark smoke
-  NF Dark smoke
-  CW Transparent
-  NW Transparent

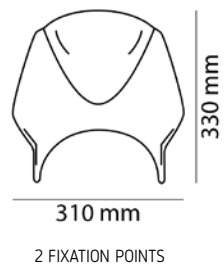



* Check availability for motorcycle models at www.puig.tv typing in the searching window.



TOP

TÜV ABE 38188

MODEL	REF.	N H
UNIVERSAL	1309	(*)

-  N Black
-  H Smoke

OPTIMUM MOUNTING FOR HEADLIGHTS Ø 200 mm.



* Check availability for motorcycle models at www.puig.tv typing in the searching window.

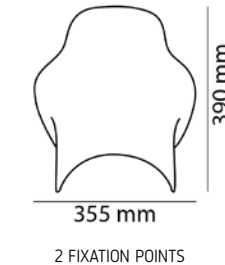



PLUS



MODEL	REF.	H	F
UNIVERSAL	4620		(*)

OPTIMUM MOUNTING FOR HEADLIGHTS Ø 200 mm.

-  H Smoke
-  F Dark Smoke

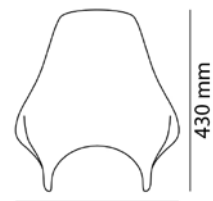

405 mm

2 FIXATION POINTS





* Check availability for motorcycle models at www.puig.tv typing in the searching window.



CUSTOM I



MODEL	RÉF.	H	W
UNIVERSAL HANDLEBARS 22/26 mm. FORKS 38/42 mm.	0840	(*)	(*)

-  H Smoke
-  W Transparent

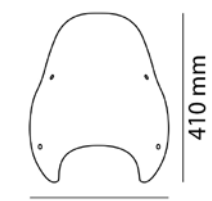

360 mm

4 FIXATION POINTS



* Check availability for motorcycle models at www.puig.tv typing in the searching window.



CUSTOM II



MODEL	REF.	H	W
UNIVERSAL HANDLEBARS 22/26 mm.	0336		(*)

- H Smoke
- W Transparent

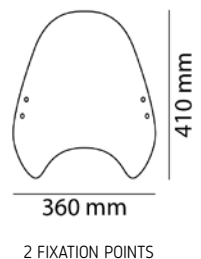

* Check availability for motorcycle models at www.puig.tv typing in the searching window.



CUSTOM II WITH VISOR



MODEL	REF.	H
UNIVERSAL HANDLEBARS 22/26 mm.	5921	(*)

- H Smoke

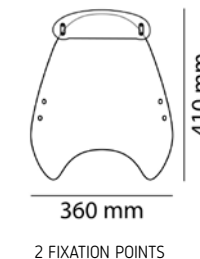

* Check availability for motorcycle models at www.puig.tv typing in the searching window.



RANGER



MODEL	REF.	H
UNIVERSAL HANDLEBARS 22/26 mm. FORKS 38/42 mm.	0328	(*)



H Smoke



510 mm

510 mm

4 FIXATION POINTS



* Check availability for motorcycle models at www.puig.tv typing in the searching window.



TOURING I



MODEL	REF.	W
UNIVERSAL HANDLEBARS 22/26 mm.	0856	(*)



W Transparent

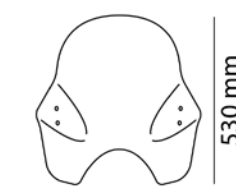

540 mm

530 mm

2 FIXATION POINTS



* Check availability for motorcycle models at www.puig.tv typing in the searching window.





ROADSTER



MODEL	REF.	H	W
UNIVERSAL A	0444	(*)	
UNIVERSAL B	0131	(*)	
UNIVERSAL C	5932	(*)	

FIXINGS TO THE FORK BARS
 FIXATIONS ON LIGHT SCREWS
 FIXINGS TO THE HANDLE OF 22/26 mm.

-  H Smoke
-  W Transparent

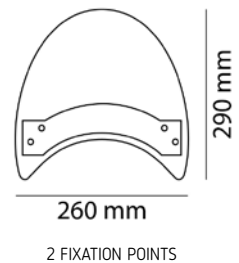



* Check availability for motorcycle models at www.puig.tv typing in the searching window.



CHOPPER



MODEL	REF.	H	W
UNIVERSAL HANDLEBARS 22/26 mm.	0854	(*)	

-  H Smoke
-  W Transparent

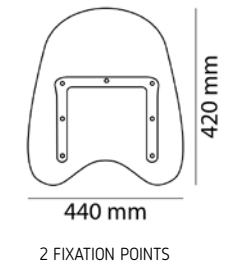

* Check availability for motorcycle models at www.puig.tv typing in the searching window.



HIGHWAY



MODEL	REF.	W
UNIVERSAL HANDLEBARS 22/26 mm.	0129	(*)

EASY-MOUNTING WINDSHIELD THROUGH 2 HANDLEBAR CLAMPS.
FOR A MORE DEMANDING FIXATION WE RECOMMEND OUR MODELS OF CARENABRÍS OF 4 POINTS OF FIXING.



* Check availability for motorcycle models at www.puig.tv typing in the searching window.

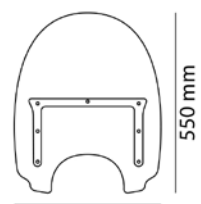

455 mm
550 mm
2 FIXATION POINTS



DAYTONA IV



MODEL	REF.	W
UNIVERSAL HANDLEBARS 22/26 mm.	2003	(*)

EASY-MOUNTING WINDSHIELD THROUGH 2 HANDLEBAR CLAMPS.
FOR A MORE DEMANDING FIXATION WE RECOMMEND OUR MODELS OF CARENABRÍS OF 4 POINTS OF FIXING.



* Check availability for motorcycle models at www.puig.tv typing in the searching window.

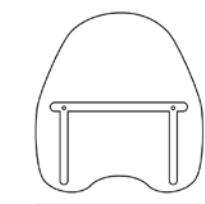

410 mm
460 mm
2 FIXATION POINTS



DAYTONA III



MODEL	REF.	W
UNIVERSAL HANDLEBARS 22/26 mm.	1984	(*)

EASY-MOUNTING WINDSHIELD THROUGH 2 HANDLEBAR CLAMPS.
FOR A MORE DEMANDING FIXATION WE RECOMMEND OUR MODELS OF CARENABRÍS OF 4 POINTS OF FIXING.



* Check availability for motorcycle models at www.puig.tv typing in the searching window.

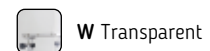

480 mm
550 mm
2 FIXATION POINTS



AMERICA I



MODEL	REF.	W
UNIVERSAL	0867	(*)

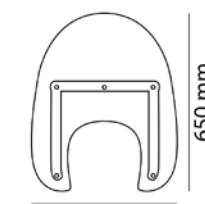

455 mm
650 mm
4 FIXATION POINTS



* Check availability for motorcycle models at www.puig.tv typing in the searching window.



AMERICA II



MODEL	REF.	Ⓜ
UNIVERSAL	0319	(*)

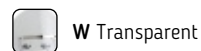

W Transparent



560 mm

4 FIXATION POINTS



* Check availability for motorcycle models at www.puig.tv typing in the searching window.



AMERICA III



MODEL	REF.	Ⓜ
UNIVERSAL	1129	(*)

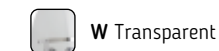

W Transparent

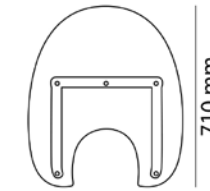

580 mm

4 FIXATION POINTS



* Check availability for motorcycle models at www.puig.tv typing in the searching window.



ANARCHY SEMI-FAIRINGS

HI-TECH PARTS | TECHNICAL SECTION



AERODYNAMIC TEST

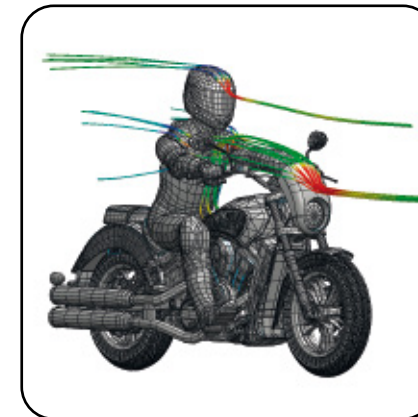

- N Black
- J Matt black



MATERIAL: ABS

MODEL	REF.
ANARCHY	SEE PAGE 192

(*) Check price with your distributor.
 IMPORTANT: Indicate code color after part#. Example 0973A.



DARK NIGHT SEMI-FAIRINGS

HI-TECH PARTS | TECHNICAL SECTION



AERODYNAMIC TEST

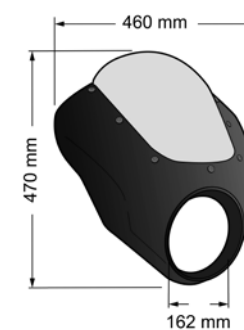

SEMI-FAIRINGS

- N Black
- J Matt black

SCREEN

- H Smoke
- F Dark Smoke



MATERIAL: ABS

MODEL	REF.
DARK NIGHT	SEE PAGE 192

(*) Check price with your distributor.
 IMPORTANT: Indicate code color after part#. Example 0973A.



BATWING SML

HI-TECH PARTS | TECHNICAL SECTION



AERODYNAMIC TEST



1 SML TOURING

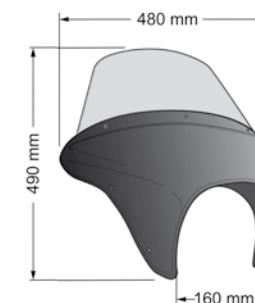

MATERIAL: ABS

AERODYNAMIC TEST



2 SML SPORT

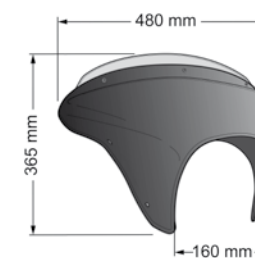



MATERIAL: ABS

SEMI-FAIRINGS

-  N Black
-  J Matt black

SCREEN

-  H Smoke
-  W Transparent

MODEL	REF.
BATWING SML TOURING (1)	SEE PAGE 192
BATWING SML SPORT (2)	SEE PAGE 192

(*) Check price with your distributor.
 IMPORTANT: Indicate code color after part#. Example 0973A.

SEMI-FAIRINGS

HI-TECH PARTS | TYPE OF SEMI-FAIRINGS:



ANARCHY

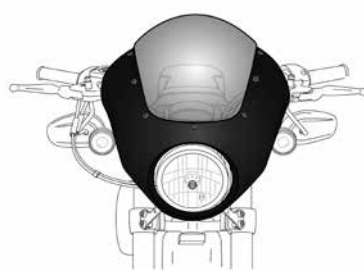

DARK NIGHT

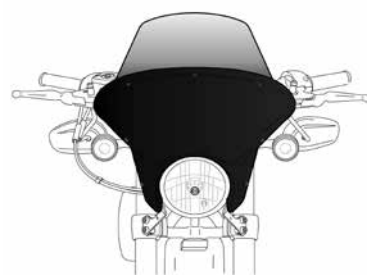

BATWING SML TOURING

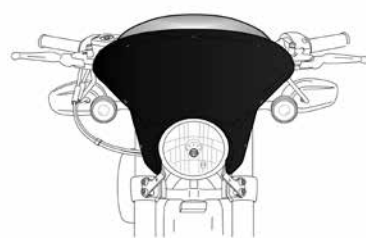

BATWING SML SPORT

MODEL	YEAR	TYPE	COLOR SEMIFAIRING	REF.	N F	H W	J
BMW							
R18	20' - 21'	BATWING SML SPORT	BLACK	21047	(*)		
R18	20' - 21'	BATWING SML TOURING	BLACK	21048	(*)		
HARLEY DAVIDSON							
DYNA STREET BOB FXDB/I	06' - 17'	BATWING SML SPORT	BLACK	21049	(*)		
DYNA STREET BOB FXDB/I	06' - 17'	BATWING SML TOURING	BLACK	21050	(*)		
DYNA STREET BOB FXDB/I	06' - 17'	ANARCHY	BLACK	21081N	(*)		
DYNA STREET BOB FXDB/I	06' - 17'	DARK NIGHT	BLACK	21095	(*)		
SOFTAIL LOW RIDER FXLR	18' - 20'	BATWING SML SPORT	BLACK	21051	(*)		
SOFTAIL LOW RIDER FXLR	18' - 20'	BATWING SML TOURING	BLACK	21052	(*)		
SOFTAIL LOW RIDER FXLR	18' - 20'	ANARCHY	BLACK	21082N	(*)		
SOFTAIL LOW RIDER FXLR	18' - 20'	DARK NIGHT	BLACK	21096	(*)		
SPORTSTER IRON XL883N	09' - 21'	BATWING SML SPORT	BLACK	21053	(*)		
SPORTSTER IRON XL883N	09' - 21'	BATWING SML TOURING	BLACK	21054	(*)		
SPORTSTER IRON XL883N	09' - 21'	ANARCHY	BLACK	21083N	(*)		
SPORTSTER IRON XL883N	09' - 21'	DARK NIGHT	BLACK	21097	(*)		
SPORTSTER IRON 1200 XL1200NS	18' - 21'	ANARCHY	BLACK	21083N	(*)		
SPORTSTER IRON 1200 XL1200NS	18' - 21'	DARK NIGHT	BLACK	21097	(*)		
SPORTSTER FORTY-EIGHT SPECIAL XL1200XS	18' - 21'	BATWING SML SPORT	BLACK	21055	(*)		
SPORTSTER FORTY-EIGHT SPECIAL XL1200XS	18' - 21'	BATWING SML TOURING	BLACK	21056	(*)		
SPORTSTER FORTY-EIGHT SPECIAL XL1200XS	18' - 21'	ANARCHY	BLACK	21084N	(*)		
SPORTSTER FORTY-EIGHT SPECIAL XL1200XS	18' - 21'	DARK NIGHT	BLACK	21098	(*)		
SPORTSTER 1200 FORTY-EIGHT XL1200X	15' - 21'	BATWING SML SPORT	BLACK	21055	(*)		
SPORTSTER 1200 FORTY-EIGHT XL1200X	15' - 21'	BATWING SML TOURING	BLACK	21056	(*)		
SPORTSTER 1200 FORTY-EIGHT XL1200X	15' - 21'	ANARCHY	BLACK	21084N	(*)		
SPORTSTER 1200 FORTY-EIGHT XL1200X	15' - 21'	DARK NIGHT	BLACK	21098	(*)		
STREET 750 XG750	17' - 21'	BATWING SML SPORT	BLACK	21057	(*)		
STREET 750 XG750	17' - 21'	BATWING SML TOURING	BLACK	21058	(*)		

MODEL	YEAR	TYPE	COLOR SEMIFAIRING	REF.	N F	H W	J
STREET 750 XG750	17' - 21'	ANARCHY	BLACK	21085N	(*)		
STREET 750 XG750	17' - 21'	DARK NIGHT	BLACK	21099	(*)		
HONDA							
CMX 500 REBEL	17' - 19'	BATWING SML SPORT	BLACK	21059	(*)		
CMX 500 REBEL	17' - 19'	BATWING SML TOURING	BLACK	21060	(*)		
CMX 500 REBEL	17' - 19'	ANARCHY	BLACK	21086N	(*)		
CMX 500 REBEL	17' - 19'	DARK NIGHT	BLACK	21100	(*)		
CMX 500 REBEL	17' - 19'	BATWING SML SPORT	MATT BLACK	21061	(*)		
CMX 500 REBEL	17' - 19'	BATWING SML TOURING	MATT BLACK	21062	(*)		
CMX 500 REBEL	17' - 19'	ANARCHY	MATT BLACK	21086J			(*)
CMX 500 REBEL	17' - 19'	DARK NIGHT	MATT BLACK	21101	(*)		
CMX 500 REBEL/S	20' - 21'	BATWING SML SPORT	BLACK	21063	(*)		
CMX 500 REBEL/S	20' - 21'	BATWING SML TOURING	BLACK	21064	(*)		
CMX 500 REBEL/S	20' - 21'	ANARCHY	BLACK	21088N	(*)		
CMX 500 REBEL/S	20' - 21'	DARK NIGHT	BLACK	21102	(*)		
CMX 500 REBEL/S	20' - 21'	BATWING SML SPORT	MATT BLACK	21065	(*)		
CMX 500 REBEL/S	20' - 21'	BATWING SML TOURING	MATT BLACK	21066	(*)		
CMX 500 REBEL/S	20' - 21'	ANARCHY	MATT BLACK	21088J			(*)
CMX 500 REBEL/S	20' - 21'	DARK NIGHT	MATT BLACK	21103	(*)		
CMX REBEL 1100	21'	BATWING SML SPORT	BLACK	21067	(*)		
CMX REBEL 1100	21'	BATWING SML TOURING	BLACK	21068	(*)		
CMX REBEL 1100	21'	ANARCHY	BLACK	21090N	(*)		
CMX REBEL 1100	21'	DARK NIGHT	BLACK	21104	(*)		
CMX REBEL 1100	21'	BATWING SML SPORT	MATT BLACK	21069	(*)		
CMX REBEL 1100	21'	BATWING SML TOURING	MATT BLACK	21070	(*)		
CMX REBEL 1100	21'	ANARCHY	MATT BLACK	21090J			(*)
CMX REBEL 1100	21'	DARK NIGHT	MATT BLACK	21105	(*)		
INDIAN							
SCOUT	15' - 21'	BATWING SML SPORT	BLACK	21071	(*)		
SCOUT	15' - 21'	BATWING SML TOURING	BLACK	21072	(*)		
SCOUT	15' - 21'	ANARCHY	BLACK	21092N	(*)		
SCOUT	15' - 21'	DARK NIGHT	BLACK	21106	(*)		
SCOUT BOBBER SIXTY	16' - 21'	BATWING SML SPORT	BLACK	21071	(*)		
SCOUT BOBBER SIXTY	16' - 21'	BATWING SML TOURING	BLACK	21072	(*)		
SCOUT BOBBER SIXTY	16' - 21'	ANARCHY	BLACK	21092N	(*)		
SCOUT BOBBER SIXTY	16' - 21'	DARK NIGHT	BLACK	21106	(*)		
SCOUT SIXTY	16' - 21'	BATWING SML SPORT	BLACK	21071	(*)		

N Black
 H Smoke
 W Transparent

 J Matt black
 F Dark Smoke

(*) Check price with your distributor.
 IMPORTANT: Indicate code color after part#. Example 0973A.

SEMI-FAIRINGS

HI-TECH PARTS | TYPE OF SEMI-FAIRINGS:



ANARCHY

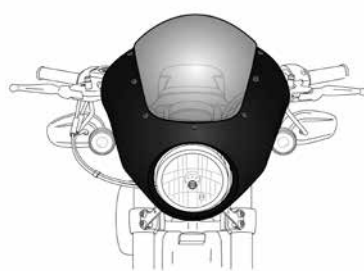

DARK NIGHT

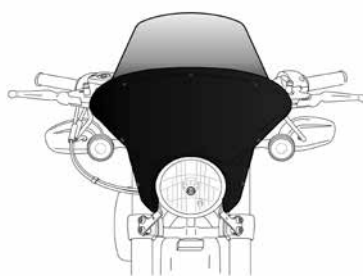

BATWING SML TOURING

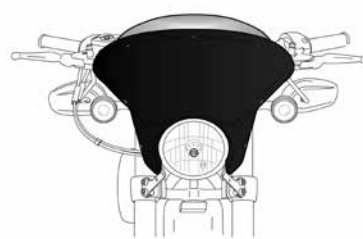

BATWING SML SPORT

MODEL	YEAR	TYPE	COLOR SEMIFAIRING	REF.	N H F W	J
SCOUT SIXTY	16' - 21'	BATWING SML TOURING	BLACK	21072	(*)	
SCOUT SIXTY	16' - 21'	ANARCHY	BLACK	21092N	(*)	
SCOUT SIXTY	16' - 21'	DARK NIGHT	BLACK	21106	(*)	
SCOUT BOBBER	18' - 21'	BATWING SML SPORT	BLACK	21073	(*)	
SCOUT BOBBER	18' - 21'	BATWING SML TOURING	BLACK	21074	(*)	
SCOUT BOBBER	18' - 21'	ANARCHY	BLACK	21092N	(*)	
SCOUT BOBBER	18' - 21'	DARK NIGHT	BLACK	21107	(*)	
KAWASAKI						
VULCAN S	15' - 21'	BATWING SML SPORT	MATT BLACK	21075	(*)	
VULCAN S	15' - 21'	BATWING SML TOURING	MATT BLACK	21076	(*)	
VULCAN S	15' - 21'	ANARCHY	MATT BLACK	21093J		(*)
VULCAN S	15' - 21'	DARK NIGHT	MATT BLACK	21108	(*)	
YAMAHA						
XV950	14' - 19'	BATWING SML SPORT	BLACK	21077	(*)	
XV950	14' - 19'	BATWING SML TOURING	BLACK	21078	(*)	
XV950	14' - 19'	ANARCHY	BLACK	21094N	(*)	
XV950	14' - 19'	DARK NIGHT	BLACK	21109	(*)	
XV950 R	14' - 21'	BATWING SML SPORT	BLACK	21077	(*)	
XV950 R	14' - 21'	BATWING SML TOURING	BLACK	21078	(*)	
XV950 R	14' - 21'	ANARCHY	BLACK	21094N	(*)	
XV950 R	14' - 21'	DARK NIGHT	BLACK	21109	(*)	

N Black
 H Smoke
 W Transparent

 J Matt black
 F Dark Smoke

(*) Check price with your distributor.
 IMPORTANT: Indicate code color after part#. Example 0973A.



NEW!



NEW!



GTS SPORT

MODEL	REF.	W
GTS 300	20500	(*)

(*) Check price with your distributor.



* Check availability for motorcycle models at www.puig.tv typing in the searching window.

- H Smoke
- W Transparent

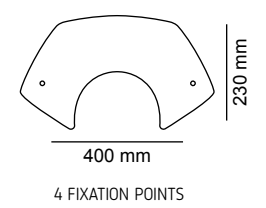

GTS TOURING

MODEL	REF.	W
GTS 300	20501	(*)

(*) Check price with your distributor.



* Check availability for motorcycle models at www.puig.tv typing in the searching window.

- H Smoke
- W Transparent

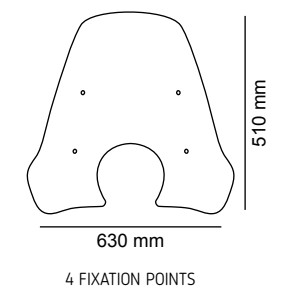



CITY TOURING

TÜV ABE 38120

MODEL	REF.	H
UNIVERSAL (RETROVISOR M8)	0572	(*)

 H Smoke

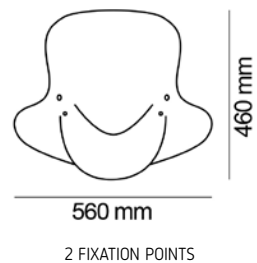



* Check availability for motorcycle models at www.puig.tv typing in the searching window.



TRAFIC

TÜV ABE 38120

MODEL	REF.	H	W
UNIVERSAL	4873	(*)	

 H Smoke
 W Transparent

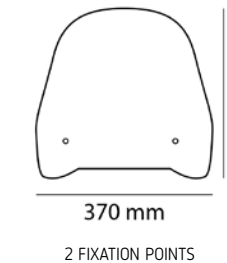

* Check availability for motorcycle models at www.puig.tv typing in the searching window.



URBAN



MODEL	REF.	H	W
UNIVERSAL	7599	(*)	(*)

- H Smoke
- W Transparent

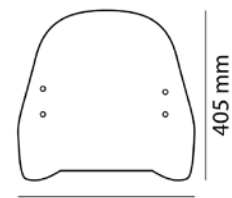

390 mm

405 mm

2 FIXATION POINTS



URBAN

* Check availability for motorcycle models at www.puig.tv typing in the searching window.



T.S.

- W Transparent

MODEL	REF.	W
UNIVERSAL	6371	(*)

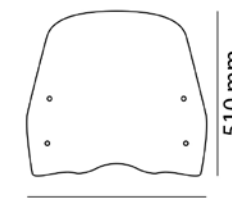

480 mm

510 mm

2 FIXATION POINTS



T.S.

* Check availability for motorcycle models at www.puig.tv typing in the searching window.



T.X.

MODEL	REF.	W
UNIVERSAL	1952	(*)

 W Transparent

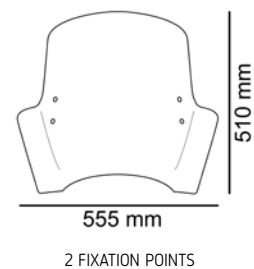

* Check availability for motorcycle models at www.puig.tv typing in the searching window.



HAND GUARDS



MODEL	REF.	W
HAND GUARDS UNIVERSAL	6855	(*)

 W Transparent



* Check availability for motorcycle models at www.puig.tv typing in the searching window.

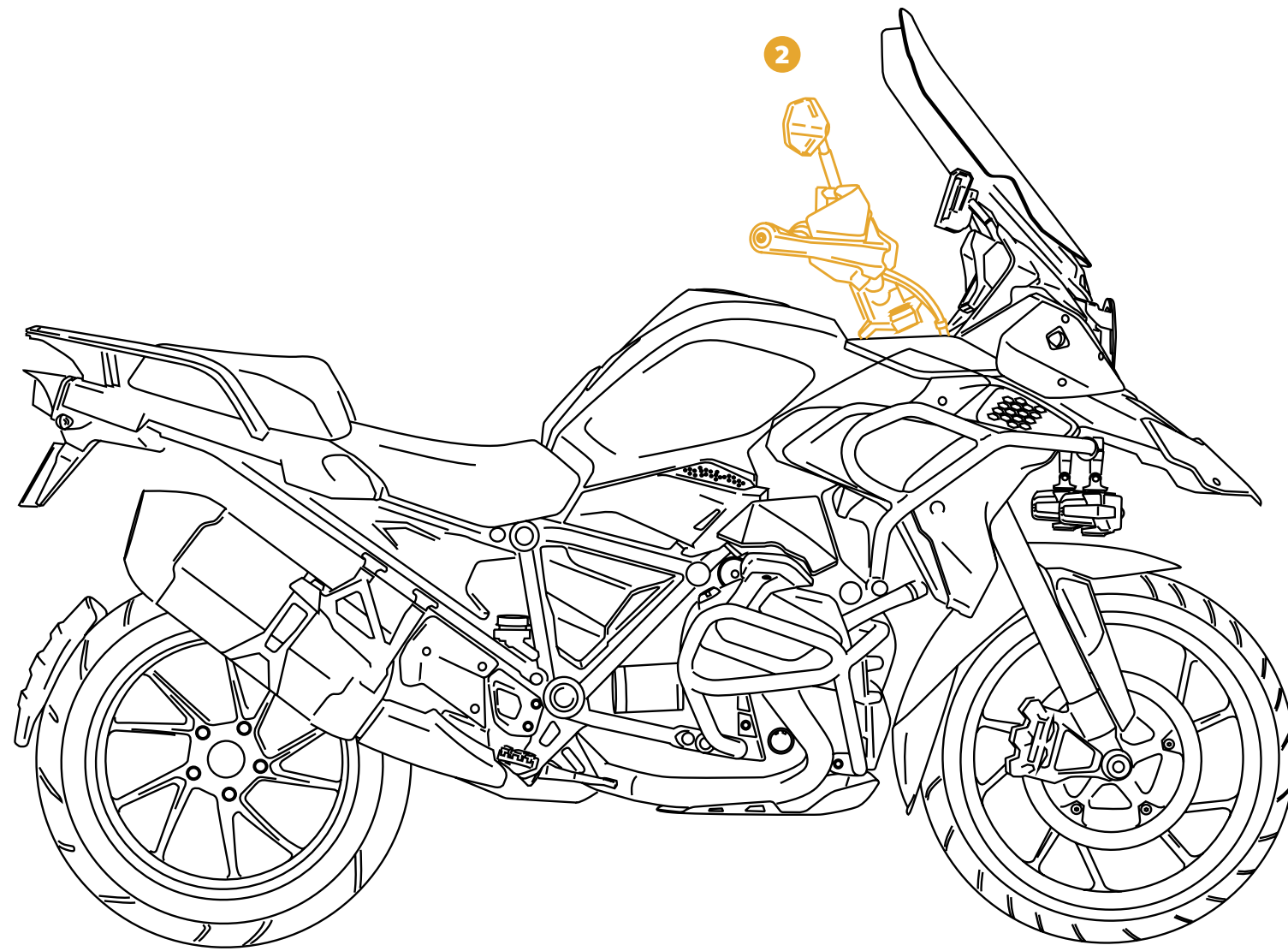

HANDLEBAR AREA

ASCENT GRIPS	263	PARKING BRAKE LEVER	259
BAR ENDS LONG AND SHORT	275	RACING GRIPS	267
BAR ENDS SHORT WITH RING AND RACE	279	RADIKAL GRIPS	265
BAR ENDS SPEED	273	REARVIEW MIRROR CAPS	315
BAR ENDS SPORT	271	REARVIEW MIRROR EXPLORER	299
BAR ENDS THRUSTER	277	REARVIEW MIRROR F1.1	305
BASIC GRIPS	269	REARVIEW MIRROR FOLD	281
BRAKE / CLUTCH LEVER PROTECTOR	229	REARVIEW MIRROR GRAND TRACKER	285
BRAKE / CLUTCH LEVER PROTECTOR ADAPTORS	230	REARVIEW MIRROR GT.1	301
BRAKE-CLUTCH LIQUID TANK COVER	250	REARVIEW MIRROR GTI	303
GLOVE FOR FRONT BRAKE TANK	251	REARVIEW MIRROR HI-TECH IV	289
HANDLEBAR DEFLECTORS	329	REARVIEW MIRROR HYPERNAKED	297
HANDLEBAR REINFORCEMENT	209	REARVIEW MIRROR LOOK	283
HANDLEBARS	207	REARVIEW MIRROR MG	309
HERITAGE LEVERS	241	REARVIEW MIRROR MONACO	293
IN-TAKE CHARGE	333	REARVIEW MIRROR MP	291
LEVERS 3.0	211	REARVIEW MIRROR MT	308
LEVERS ADAPTERS	214	REARVIEW MIRROR RETRO	295
MAXISCOOTER HANDGUARDS	321	REARVIEW MIRROR RS1	306
MOBILE CASE	333	REARVIEW MIRROR RS2	307
MOBILE PHONE SUPPORT	331	REARVIEW MIRROR TRACKER	287
MOBILE SUPPORT BRAKE-CLUTCH LIQUID CAP	335	REARVIEW MIRROR Z1	310
MOBILE SUPPORTS	337	REARVIEW MIRROR Z2	311
MOTORCYCLE HANDGUARD EXTENSIONS	319	RISERS	208
MOTORCYCLE HANDGUARDS	317	SCOOTER LEVERS	239
OFF-ROAD LEVERS	243	THERMAL GLOVES ANTI-VIBRATION	227
ORIGINAL REARVIEW MIRRORS CAPS, SUPPORT AND SHIFTER	313	VINTAGE GRIPS	261



HANDLEBARS

HI-TECH PARTS | TECHNICAL SECTION

REF. 7493N

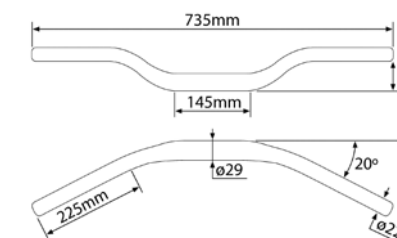

CONICAL HANDLEBAR

Ø mm.	H (mm.)	REF.	R O A N P
22/29	20	7492	(*)
22/29	40	7493	(*)
22/29	61	6461	(*)

REF. 7494N

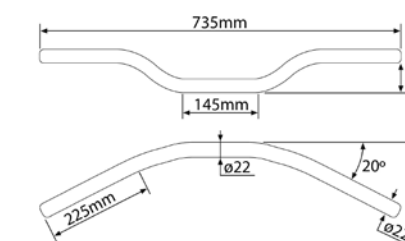
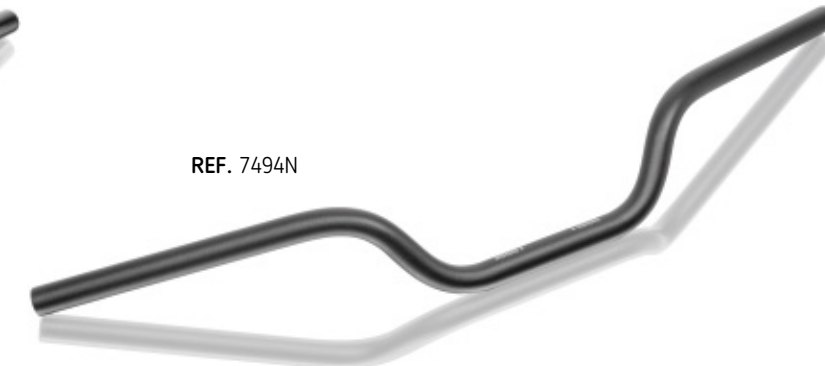

CYLINDRIC HANDLEBAR

Ø mm.	H (mm.)	REF.	R O A N P
22	76	6242	(*)
22	46	7494	(*)

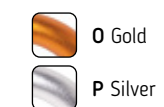
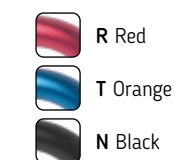

HANDLEBARS SUITABLE FOR OUR BAR ENDS [SEE WEBSITE](#).
PUIG HANDLEBARS INCORPORATE INTERIOR THREAD.

(*) Check price with your distributor.
IMPORTANT: Indicate code color after part#. Example 0973A.



RISERS

HI-TECH PARTS | TECHNICAL SECTION

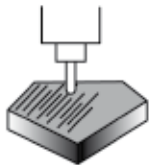

CNC MACHINED
Machined from billet aluminium and anodized in different colors.

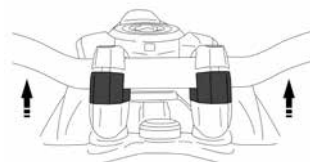

FUNCTIONAL
Allows the handlebars to be raised

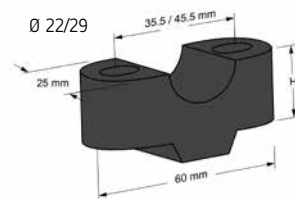

- N Black
- P Aluminium

(*) Check price with your distributor.
IMPORTANT: Indicate code color after part#. Example 0973A.



HANDLEBAR REINFORCEMENT

HI-TECH PARTS | TECHNICAL SECTION



REF. 3672-3741
Ø 22/29



REF. 3671-3740
Ø 22/29



REF. 3671-3740
Ø 22/29

H (mm.)	Ø mm.	REF.	N P
20	22	3671	(*)
20	29	3740	(*)
20	32	20308	(*)
30	22	3672	(*)
30	29	3741	(*)
30	32	20309	(*)
20	25	20667	(*)

MODEL	YEAR	REF.	R A N P
YAMAHA			
MT-07 TRACER	16' - 18'	9256	(*)

ALUMINIUM BASE.

- R Red
- A Blue
- N Black
- P Aluminium

REF. 9256N



(*) Check price with your distributor.
IMPORTANT: Indicate code color after part#. Example 0973A.



LEVERS 3.0

HI-TECH PARTS | TECHNICAL SECTION

TÜV ABE
91294

REF. 210AA



REF. 220NA



REF. 230NA



REF. 24ANA



FOLDABLE MODEL 3.0	REF.	R O A T N P V
FOLDABLE BRAKE LEVER	SEE PAGE 212	(*)
ADAPTOR BRAKE LEVER	SEE PAGE 214	
FOLDABLE CLUTCH LEVER	SEE PAGE 212	(*)
ADAPTOR CLUTCH LEVER	SEE PAGE 214	
SELECTOR (SPARES)	3699	(*)
SCREW-NUT-SPACER-WASHER SPRING (SPARES)	9837	(*)
SPRING	3512	(*)

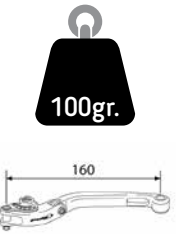

NON-FOLDABLE MODEL 3.0	REF.	R O A T N P V
NON-FOLDABLE BRAKE LEVER	SEE PAGE 212	(*)
ADAPTOR BRAKE LEVER	SEE PAGE 214	
NON-FOLDABLE CLUTCH LEVER	SEE PAGE 212	(*)
ADAPTOR CLUTCH LEVER	SEE PAGE 214	
SELECTOR (SPARES)	3699	(*)
SCREW-NUT-SPACER-WASHER SPRING (SPARES)	9837	(*)
SPRING	3512	(*)

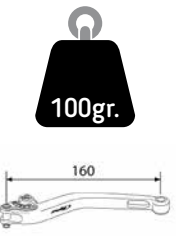

SHORT MODEL 3.0	REF.	R O A T N P V
SHORT BRAKE HANDLE	SEE PAGE 212	(*)
ADAPTOR BRAKE LEVER	SEE PAGE 214	
SHORT CLUTCH LEVER	SEE PAGE 212	(*)
ADAPTOR CLUTCH LEVER	SEE PAGE 214	
SELECTOR (SPARES)	3699	(*)
SCREW-NUT-SPACER-WASHER SPRING (SPARES)	9837	(*)
SPRING	3512	(*)

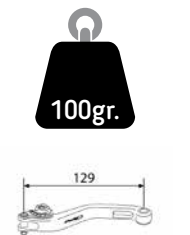

EXTENDABLE FOLDING MODEL 3.0	REF.	R O A T N P V
EXTENDABLE FOLDABLE BRAKE LEVER	SEE PAGE 212	(*)
ADAPTOR BRAKE LEVER	SEE PAGE 214	
EXTENDABLE FOLDABLE CLUTCH LEVER	SEE PAGE 212	(*)
ADAPTOR CLUTCH LEVER	SEE PAGE 214	
SELECTOR (SPARES)	3699	(*)
EXTENDABLE KIT	3700	(*)
SCREW-NUT-SPACER-WASHER SPRING (SPARES)	9837	(*)
SET OF SCREW+WASHER FOR EXTENDABLE SECTION (SPARES)	20503	(*)
SPRING	3512	(*)

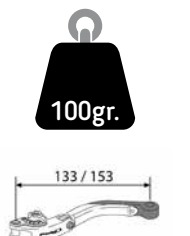

LEVERS ADAPTERS

HI-TECH PARTS

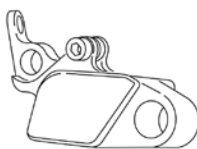
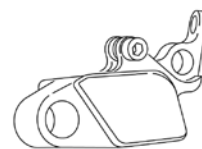

2022		For the new 2022 motorcycle models check www.puig.tv			
MODEL	YEAR	ADAPTOR CLUTCH LEVER	N	ADAPTOR BRAKE LEVER	N
APRILIA					
DORSODURO 900	17' - 21'	6140N	(*)	6144N	(*)
RSV4	09' - 12'	8503N	(*)	6141N	(*)
RSV4 FACTORY	13' - 14'	8503N	(*)	6141N	(*)
RSV4 RF	15' - 20'	8503N	(*)	6141N	(*)
RSV4 RR	15' - 20'	8503N	(*)	6141N	(*)
SHIVER 750	07' - 16'	6140N	(*)	6144N	(*)
SHIVER 900	17' - 21'	6140N	(*)	6144N	(*)
TUONO 660	21'	8503N	(*)	6141N	(*)
TUONO V4R	11' - 14'	8503N	(*)	6578N	(*)
TUONO V4 1100 RR	15' - 16'	8503N	(*)	6578N	(*)
TUONO V4 1100 RR	17' - 21'	8503N	(*)	6141N	(*)
TUONO V4 1100 FACTORY	15' - 16'	8503N	(*)	6578N	(*)
TUONO V4 1100 FACTORY	17' - 20'	8503N	(*)	6141N	(*)
BENELLI					
LEONCINO 500	16' - 21'	9695N	(*)	9694N	(*)
TRK 251	20' - 21'	20551N	(*)	9694N	(*)
TRK 502	16' - 19'	9695N	(*)	9694N	(*)
TRK 502	20' - 21'	20551N	(*)	9694N	(*)
TRK 502 X	16' - 19'	9695N	(*)	9694N	(*)
TRK 502 X	20' - 21'	20551N	(*)	9694N	(*)
BMW					
C400X	19' - 21'	20823N (rear brake)	(*)	20824N (front brake)	(*)
C400GT	19' - 21'	20823N (rear brake)	(*)	20824N (front brake)	(*)
C600 SPORT	12' - 15'	6358N (rear brake)	(*)	6356N (front brake)	(*)
C650 SPORT	16' - 20'	6358N (rear brake)	(*)	6356N (front brake)	(*)
C650 GT	12' - 15'	6358N (rear brake)	(*)	6356N (front brake)	(*)
C650 GT	16' - 20'	6358N (rear brake)	(*)	6356N (front brake)	(*)
F650 GS	08' - 12'	6585N	(*)	6142N	(*)
F700 GS	12' - 17'	6585N	(*)	6142N	(*)
F750 GS	18' - 21'	9783N	(*)	7839N	(*)
F800 GT	13' - 20'	6585N	(*)	6142N	(*)
F800 GS	08' - 17'	6585N	(*)	6142N	(*)
F800 GS ADVENTURE	13' - 17'	6585N	(*)	6142N	(*)
F800R	09' - 20'	6585N	(*)	6142N	(*)
F850 GS	18' - 21'	9783N	(*)	7839N	(*)
F850 GS ADVENTURE	19' - 21'	9783N	(*)	7839N	(*)

2022		For the new 2022 motorcycle models check www.puig.tv			
MODEL	YEAR	ADAPTOR CLUTCH LEVER	N	ADAPTOR BRAKE LEVER	N
F900R	20' - 21'	9783N	(*)	7839N	(*)
F900XR	20' - 21'	9783N	(*)	7839N	(*)
G310 GS	17' - 20'	8609N	(*)	6143N	(*)
G310GS	21'	20684N	(*)	6143N	(*)
G310 R	16' - 20'	8609N	(*)	6143N	(*)
G310R	21'	20684N	(*)	6143N	(*)
G650 GS	11' - 16'	6139N	(*)	6143N	(*)
R1200 R	06' - 14'	6137N	(*)	6142N	(*)
R1200 R	15' - 18'	6581N	(*)	6582N	(*)
R1200 RS	15' - 18'	6581N	(*)	6582N	(*)
R1200 GS	04' - 07'	6330N	(*)	6142N	(*)
R1200 GS	08' - 12'	6137N	(*)	6142N	(*)
R1200 GS	13' - 18'	6581N	(*)	6582N	(*)
R1200GS EXCLUSIVE	17' - 18'	6581N	(*)	6582N	(*)
R1200GS RALLYE	17' - 18'	6581N	(*)	6582N	(*)
R1200 GS ADVENTURE	07' - 13'	6137N	(*)	6142N	(*)
R1250 GS	18' - 21'	6581N	(*)	6582N	(*)
R1250 GS HP	18' - 21'	6581N	(*)	6582N	(*)
R1250GS ADVENTURE	18' - 20'	6581N	(*)	6582N	(*)
R1250GS RALLYE	18' - 21'	6581N	(*)	6582N	(*)
R1250 R	18' - 21'	6581N	(*)	3628N	(*)
R1250 RS	19' - 21'	6581N	(*)	3628N	(*)
R NINE T	14'	6581N	(*)	6582N	(*)
R NINE T (#)	15' - 16'	6581N	(*)	6582N	(*)
R NINE T (&)	15' - 16'	8618N	(*)	7839N	(*)
R NINE T	17' - 21'	8618N	(*)	7839N	(*)
R NINE T SCRAMBLER	16' - 21'	8618N	(*)	7839N	(*)
R NINE T PURE	17' - 21'	8618N	(*)	7839N	(*)
R NINE T RACER	17' - 20'	8618N	(*)	7839N	(*)
R NINE T URBAN G/S	17' - 21'	8618N	(*)	7839N	(*)
S1000 R	14' - 20'	7171N	(*)	5458N	(*)
S1000 R	21'	9783N	(*)	7839N	(*)
S1000RR	09' - 14'	5750N	(*)	5458N	(*)
S1000RR	15' - 18'	7171N	(*)	5458N	(*)
S1000RR	19' - 21'	9783N	(*)	5458N	(*)
S1000 XR	15' - 19'	7808N	(*)	7839N	(*)
S1000 XR	20' - 21'	9783N	(*)	7839N	(*)
DUCATI					
749S	03' - 06'	6138N	(*)	6141N	(*)
749R	03' - 06'	6138N	(*)	6141N	(*)

N Black

(#) With production code WB10J01 from now on.
 (#) BMW R NINE T with production code 0A6, 0A16
 (&) BMW R NINE T with a production code 0J01, 0J03
 (*) Check price with your distributor.

IMPORTANT: Indicate code color after part#. Example 0973A.

LEVERS ADAPTERS

HI-TECH PARTS

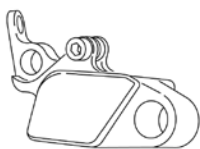
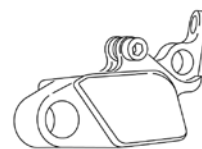

2022		For the new 2022 motorcycle models check www.puig.tv			
MODEL	YEAR	ADAPTOR CLUTCH LEVER	N	ADAPTOR BRAKE LEVER	N
848	08' - 10'	6138N	(*)	6141N	(*)
899 PANIGALE	14' - 15'	6138N	(*)	6141N	(*)
959 PANIGALE	16' - 19'	6138N	(*)	6141N	(*)
959 PANIGALE CORSE	18' - 19'	6138N	(*)	6141N	(*)
999S	05' - 06'	6138N	(*)	6141N	(*)
999R	05' - 06'	6138N	(*)	6141N	(*)
1098	07' - 08'	6138N	(*)	6141N	(*)
1198	09' - 11'	6138N	(*)	6141N	(*)
1198S	09' - 11'	6138N	(*)	6141N	(*)
1199 PANIGALE	12' - 14'	6138N	(*)	6141N	(*)
1199 SUPERLEGGERA	14'	6138N	(*)	6141N	(*)
1299 PANIGALE/S	15' - 17'	6138N	(*)	6141N	(*)
DIAVEL	11' - 18'	6138N	(*)	6141N	(*)
DIAVEL 1260/S	19' - 21'	6138N	(*)	6141N	(*)
HYPERMOTARD 821	13' - 15'	6590N	(*)	5444N	(*)
HYPERMOTARD 821 SP	13' - 15'	6590N	(*)	7980N	(*)
HYPERMOTARD 939	16' - 18'	6590N	(*)	5444N	(*)
HYPERMOTARD 939 SP	16' - 18'	6590N	(*)	5444N	(*)
HYPERMOTARD 950/SP	19' - 21'	6138N	(*)	6141N	(*)
HYPERMOTARD 950 RVE	21'	6138N	(*)	6141N	(*)
HYPERSTRADA	13' - 15'	6590N	(*)	5444N	(*)
HYPERSTRADA 939	16' - 17'	6590N	(*)	5444N	(*)
MONSTER 696	08' - 14'	5443N	(*)	5444N	(*)
MONSTER 796	10' - 14'	5443N	(*)	5444N	(*)
MONSTER 797	17' - 20'	6590N	(*)	5444N	(*)
MONSTER 821	14' - 20'	6590N	(*)	5444N	(*)
MONSTER 937	21'	6138N	(*)	6141N	(*)
MONSTER 937 PLUS	21'	6138N	(*)	6141N	(*)
MONSTER 1100	09' - 10'	6138N	(*)	6141N	(*)
MONSTER 1100 EVO	11' - 13'	6138N	(*)	6141N	(*)
MONSTER 1200/S	14' - 16'	6138N	(*)	6141N	(*)
MONSTER 1200/S	17' - 21'	6138N	(*)	6141N	(*)
MONSTER 1200 R	16' - 20'	6138N	(*)	6141N	(*)
MULTISTRADA 950	17' - 18'	6590N	(*)	5444N	(*)
MULTISTRADA 950	19' - 21'	6138N	(*)	6141N	(*)
MULTISTRADA 1200/S	10' - 17'	6138N	(*)	6141N	(*)
MULTISTRADA 1200 PIKES PEAK	16' - 17'	6138N	(*)	6141N	(*)

2022		For the new 2022 motorcycle models check www.puig.tv			
MODEL	YEAR	ADAPTOR CLUTCH LEVER	N	ADAPTOR BRAKE LEVER	N
MULTISTRADA 1200 ENDURO	16' - 19'	6138N	(*)	6141N	(*)
MULTISTRADA 1260/S/S DJAIR	18' - 20'	6138N	(*)	6141N	(*)
MULTISTRADA 1260 PIKES PEAK	18' - 20'	6138N	(*)	6141N	(*)
MULTISTRADA 1260 ENDURO	18' - 21'	6138N	(*)	6141N	(*)
MULTISTRADA V4	21'	20268N	(*)	6141N	(*)
MULTISTRADA V4/S SPORT	21'	20268N	(*)	6141N	(*)
PANIGALE V2	20' - 21'	6138N	(*)	6141N	(*)
PANIGALE V2 BAYLISS	21'	6138N	(*)	6141N	(*)
SCRAMBLER 1100	18' - 21'	3876N	(*)	5444N	(*)
SCRAMBLER 1100 SPORT	18' - 21'	3876N	(*)	5444N	(*)
SCRAMBLER 1100 SPECIAL	18' - 21'	3876N	(*)	5444N	(*)
SCRAMBLER CAFE RACER	17' - 18'	6590N	(*)	7980N	(*)
SCRAMBLER CAFE RACER	19' - 21'	6138N	(*)	7980N	(*)
SCRAMBLER DESERT SLED	17' - 18'	6590N	(*)	5444N	(*)
SCRAMBLER DESERT SLED	19' - 20'	3876N	(*)	5444N	(*)
SCRAMBLER FLAT TRACK PRO	16'	6590N	(*)	5444N	(*)
SCRAMBLER ICON/CLASSIC/FULL THROTTLE	15' - 18'	6590N	(*)	5444N	(*)
SCRAMBLER ICON/CLASSIC/FULL THROTTLE	19' - 21'	3876N	(*)	5444N	(*)
SCRAMBLER SIXTY2	16' - 18'	6590N	(*)	5444N	(*)
SCRAMBLER SIXTY2	19' - 21'	3876N	(*)	5444N	(*)
SCRAMBLER URBAN ENDURO	15' - 16'	6590N	(*)	5444N	(*)
STREETFIGHTER 848	12' - 15'	6138N	(*)	6141N	(*)
STREETFIGHTER 1100	09' - 12'	6138N	(*)	6141N	(*)
STREETFIGHTER 1100 S	09' - 13'	6138N	(*)	6141N	(*)
STREETFIGHTER V4/S	20' - 21'	6138N	(*)	6141N	(*)
SUPERSPORT 939/S	17' - 20'	6590N	(*)	6141N	(*)
SUPERSPORT 950/S	21'	6138N	(*)	6141N	(*)
X DIAVEL/S	16' - 21'	6138N	(*)	6141N	(*)
HONDA					
CB125R NEO SPORTS CAFE	18' - 21'	6115N	(*)	6604N	(*)
CB300R NEO SPORTS CAFE	18' - 21'	6115N	(*)	6604N	(*)
CB500F	13' - 21'	6115N	(*)	6604N	(*)
CB500X	13' - 21'	6115N	(*)	6604N	(*)
CB600F HORNET	98' - 06'	5450N	(*)	5446N	(*)
CB600F HORNET	07' - 15'	5929N	(*)	5446N	(*)
CB650F	14' - 16'	9744N	(*)	5446N	(*)
CB650F	17' - 20'	9744N	(*)	5446N	(*)
CB650R NEO SPORTS CAFE	19' - 21'	9744N	(*)	5446N	(*)
CB900F HORNET	02' - 05'	5450N	(*)	5446N	(*)
CB1000R	08' - 16'	5449N	(*)	5448N	(*)

N Black

(#) With production code WB10J01 from now on.
 (#) BMW R NINE T with production code 0A6, 0A16
 (S) BMW R NINE T with a production code 0J01, 0J03
 (*) Check price with your distributor.

IMPORTANT: Indicate code color after part#. Example 0973A.

LEVERS ADAPTERS

HI-TECH PARTS

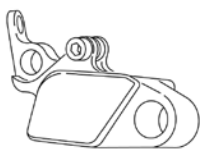
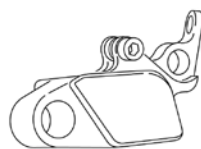

2022		For the new 2022 motorcycle models check www.puig.tv				
MODEL	YEAR	ADAPTOR CLUTCH LEVER	N	ADAPTOR BRAKE LEVER	N	
CB1000R NEO SPORTS CAFE	18' - 21'	9505N	(*)	5448N	(*)	
CB1000R BLACK EDITION	21'	9505N	(*)	5448N	(*)	
CB1100	13' - 14'	5449N	(*)	5446N	(*)	
CB1100RS	17' - 21'	5449N	(*)	5446N	(*)	
CB1100EX	17' - 21'	5449N	(*)	5446N	(*)	
CB1300	03' - 10'	5449N	(*)	5446N	(*)	
CB1300 ABS	03' - 10'	5449N	(*)	5446N	(*)	
CBF600/S	04' - 07'	5450N	(*)	5446N	(*)	
CBF600/S	08' - 14'	5929N	(*)	5446N	(*)	
CBR250R	11' - 15'	6115N	(*)	6604N	(*)	
CBR500R	13' - 21'	6115N	(*)	6604N	(*)	
CBR650R	19' - 21'	9744N	(*)	5446N	(*)	
CBR600F	86' - 07'	5450N	(*)	5446N	(*)	
CBR600F	11' - 13'	5929N	(*)	5446N	(*)	
CBR600RR	03' - 06'	5445N	(*)	5447N	(*)	
CBR600RR	07' - 16'	5445N	(*)	5448N	(*)	
CBR650F	14' - 16'	9744N	(*)	5446N	(*)	
CBR650F	17' - 19'	9744N	(*)	5446N	(*)	
CBR900RR FIRE BLADE	96' - 99'	5450N	(*)	5446N	(*)	
CBR900RR FIRE BLADE	00' - 01'	5450N	(*)	5447N	(*)	
CBR900RR FIRE BLADE	02' - 03'	5445N	(*)	5447N	(*)	
CBR1000RR FIREBLADE	04' - 07'	5449N	(*)	5448N	(*)	
CBR1000RR FIREBLADE	08' - 11'	5445N	(*)	5448N	(*)	
CBR1000RR FIREBLADE	12' - 13'	5445N	(*)	5448N	(*)	
CBR1000RR FIREBLADE/SP	14' - 16'	5445N	(*)	5448N	(*)	
CBR1000RR FIREBLADE/SP/SP2	17' - 19'	9505N	(*)	5448N	(*)	
CBR1000RR FIREBLADE	20' - 21	9505N	(*)	5448N	(*)	
CBR1000RR FIREBLADE SP	20' - 21	9505N	(*)	6141N	(*)	
CRF1000L AFRICA TWIN	16' - 19'	8657N	(*)	5446N	(*)	
CRF1100L AFRICA TWIN	20'	3868N	(*)	3867N	(*)	
CRF1100L AFRICA TWIN ADVENTURE SPORTS	20'	3868N	(*)	3867N	(*)	
CROSSRUNNER	11' - 14'	5449N	(*)	5446N	(*)	
CROSSRUNNER	15' - 21'	5449N	(*)	5446N	(*)	
CROSSTOURER	12' - 21'	5449N	(*)	5446N	(*)	
FORZA 350	21'	6118N (rear brake)	(*)	5446N (front brake)	(*)	
FORZA 750	21'	6118N (rear brake)	(*)	5446N (front brake)	(*)	
INTEGRA 700	12' - 13'	6118N (rear brake)	(*)	5446N (front brake)	(*)	

2022		For the new 2022 motorcycle models check www.puig.tv				
MODEL	YEAR	ADAPTOR CLUTCH LEVER	N	ADAPTOR BRAKE LEVER	N	
INTEGRA 750	14' - 15'	6118N (rear brake)	(*)	5446N (front brake)	(*)	
INTEGRA 750	16' - 21'	6118N (rear brake)	(*)	5446N (front brake)	(*)	
INTEGRA 750S	14' - 16'	6118N (rear brake)	(*)	5446N (front brake)	(*)	
MONKEY 125	18' - 21'	6115N	(*)	6604N	(*)	
MSX125	14' - 20'	6115N	(*)	6604N	(*)	
NC700S/X	12' - 13'	6115N	(*)	5446N	(*)	
NC750S/X	14' - 15'	6115N	(*)	5446N	(*)	
NC750S/X	16' - 21'	9744N	(*)	5446N	(*)	
NT700V DEAUVILLE	06' - 12'	5450N	(*)	5446N	(*)	
VFR800	02' - 13'	5449N	(*)	5446N	(*)	
VFR800F	14' - 20'	5449N	(*)	5446N	(*)	
VTR1000 SP-1	00' - 02'	5449N	(*)	5447N	(*)	
VTR1000 SP-2	02' - 05'	5449N	(*)	5447N	(*)	
VFR1200F	10' - 16'	5449N	(*)	6879N	(*)	
X-ADV	17' - 21'	6118N (rear brake)	(*)	5446N (front brake)	(*)	
INDIAN						
FTR 1200	19' - 21'	20464N	(*)	6141N	(*)	
FTR 12000 S	19' - 21'	20464N	(*)	6141N	(*)	
KAWASAKI						
ER-5 TWISTER	04' - 05'	5454N	(*)	5455N	(*)	
ER-6F	06' - 08'	5454N	(*)	5455N	(*)	
ER-6F	09' - 16'	5454N	(*)	5831N	(*)	
ER-6N	06' - 08'	5454N	(*)	5455N	(*)	
ER-6N	09' - 16'	5454N	(*)	5831N	(*)	
GPZ500S	90' - 95'	5454N	(*)	5455N	(*)	
J125	15' - 18'	9396N (rear brake)	(*)	9395N (front brake)	(*)	
J300	13' - 16'	9396N (rear brake)	(*)	9395N (front brake)	(*)	
KLE500	91' - 97'	5454N	(*)	5455N	(*)	
NINJA H2	15' - 21'	6138N	(*)	6141N	(*)	
NINJA 125	19' - 21'	5753N	(*)	5754N	(*)	
NINJA 250R	08' - 12'	5753N	(*)	5754N	(*)	
NINJA 250SL	15' - 16'	5753N	(*)	5754N	(*)	
NINJA 300	13' - 17'	5753N	(*)	5754N	(*)	
NINJA 400	18' - 21'	5753N	(*)	5754N	(*)	
NINJA 650	17' - 21'	5454N	(*)	6609N	(*)	
NINJA 1000 SX	20' - 21'	3496N	(*)	3497N	(*)	
VERSYS-X 300	17' - 20'	5753N	(*)	5754N	(*)	
VERSYS 650	06' - 08'	5454N	(*)	5455N	(*)	
VERSYS 650	09' - 14'	5454N	(*)	5831N	(*)	
VERSYS 650	15' - 21'	5454N	(*)	6609N	(*)	

N Black

(#) With production code WB10J01 from now on.
 (#) BMW R NINE T with production code 0A6, 0A16
 (S) BMW R NINE T with a production code 0J01, 0J03
 (*) Check price with your distributor.

IMPORTANT: Indicate code color after part#. Example 0973A.

LEVERS ADAPTERS

HI-TECH PARTS

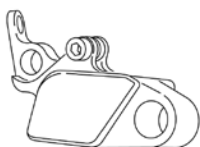

2022					
For the new 2022 motorcycle models check www.puig.tv					
MODEL	YEAR	ADAPTOR CLUTCH LEVER	N	ADAPTOR BRAKE LEVER	N
VERSYS 1000	12' - 14'	5451N	(*)	5455N	(*)
VERSYS 1000	15' - 18'	5454N	(*)	6609N	(*)
VERSYS 1000	19' - 20'	3496N	(*)	3497N	(*)
VERSYS 1000 SE	19' - 20'	3496N	(*)	3497N	(*)
VULCAN S	15' - 21'	5454N	(*)	6609N	(*)
VULCAN S CAFE	17' - 20'	5454N	(*)	6609N	(*)
Z125	17' - 21'	5753N	(*)	5754N	(*)
Z250SL	15' - 16'	5753N	(*)	5754N	(*)
Z300	15' - 17'	5753N	(*)	5754N	(*)
Z400	19' - 21'	5753N	(*)	5754N	(*)
Z650	17' - 21'	5454N	(*)	6609N	(*)
Z750	04' - 06'	5454N	(*)	5455N	(*)
Z750	07' - 12'	5451N	(*)	5453N	(*)
Z750R	11' - 12'	5451N	(*)	5452N	(*)
Z800	13' - 16'	5451N	(*)	6609N	(*)
Z800E	13' - 16'	5451N	(*)	6609N	(*)
Z900	17' - 21'	5454N	(*)	6609N	(*)
Z900RS	18' - 21'	5454N	(*)	5452N	(*)
Z900RS CAFÉ	18' - 21'	5454N	(*)	5452N	(*)
Z1000	03' - 06'	5451N	(*)	5455N	(*)
Z1000	07' - 13'	5451N	(*)	5452N	(*)
Z1000	14' - 16'	5451N	(*)	5452N	(*)
Z1000/R	17' - 21'	5454N	(*)	5452N	(*)
Z1000SX	11' - 16'	5451N	(*)	5452N	(*)
Z1000SX	17' - 19'	5454N	(*)	5452N	(*)
ZEPHYR 750	91' - 99'	5454N	(*)	5455N	(*)
ZH2	20' - 21'	20512N	(*)	3497N	(*)
Z H2 SE	20' - 21'	20512N	(*)	6141N	(*)
ZR7	99' - 03'	5454N	(*)	5455N	(*)
ZR7S	01' - 03'	5454N	(*)	5455N	(*)
ZX-6R	94' - 99'	5454N	(*)	5455N	(*)
ZX-6R	00' - 04'	5451N	(*)	5455N	(*)
ZX-6R	05' - 06'	5451N	(*)	5458N	(*)
ZX-6R	07' - 16'	5451N	(*)	5452N	(*)
ZX-6R	18' - 21'	5454N	(*)	5452N	(*)
ZX-6R 636	13' - 16'	5451N	(*)	5452N	(*)
ZX-9R	98' - 99'	5454N	(*)	5455N	(*)

2022		For the new 2022 motorcycle models check www.puig.tv			
MODEL	YEAR	ADAPTOR CLUTCH LEVER	N	ADAPTOR BRAKE LEVER	N
ZX-9R	00' - 04'	5451N	(*)	5455N	(*)
ZX-10R	04' - 05'	5451N	(*)	5455N	(*)
ZX-10R	06' - 10'	5451N	(*)	5452N	(*)
ZX-10R	11' - 15'	5451N	(*)	5452N	(*)
ZX-10R	16' - 20'	5451N	(*)	6141N	(*)
ZX-10R	21'	20536N	(*)	6141N	(*)
ZX-10RR	17' - 20'	5451N	(*)	6141N	(*)
ZX-10RR	21'	20536N	(*)	6141N	(*)
ZX-10R SE	18' - 20'	5451N	(*)	6141N	(*)
ZX-12R	00' - 06'	5451N	(*)	5455N	(*)
ZZR600	93' - 04'	5454N	(*)	5455N	(*)
ZZR600	05' - 06'	5451N	(*)	5455N	(*)
ZZR1400	12' - 21'	6126N	(*)	5452N	(*)
KTM					
125 DUKE	14' - 16'	7727N	(*)	7728N	(*)
125 DUKE	17' - 21'	7727N	(*)	9511N	(*)
200 DUKE	12' - 15'	7727N	(*)	7728N	(*)
390 ADVENTURE	20' - 21'	7727N	(*)	9511N	(*)
390 DUKE	13' - 16'	7727N	(*)	7728N	(*)
390 DUKE	17' - 21'	7727N	(*)	9511N	(*)
790 DUKE	18' - 21'	9686N	(*)	9688N	(*)
890 DUKE R	20' - 21'	9686N	(*)	20552	(*)
1290 SUPERDUKE R	14' - 21'	3639N	(*)	6141N	(*)
1290 SUPERDUKE GT	16' - 20'	3639N	(*)	6141N	(*)
KYMCO					
AK550	17' - 21'	9811N (rear brake)	(*)	9811N (front brake)	(*)
DOWNTOWN 125i	09' - 14'	9396N (rear brake)	(*)	9395N (front brake)	(*)
DOWNTOWN 300i	09' - 14'	9396N (rear brake)	(*)	9395N (front brake)	(*)
G-DINK 50	12' - 18'	9396N (rear brake)	(*)	9395N (front brake)	(*)
G-DINK 125i	12' - 18'	9396N (rear brake)	(*)	9395N (front brake)	(*)
G-DINK 300i	12' - 18'	9396N (rear brake)	(*)	9395N (front brake)	(*)
K-XCT 125i	13' - 16'	9396N (rear brake)	(*)	9395N (front brake)	(*)
K-XCT 300i	13' - 16'	9396N (rear brake)	(*)	9395N (front brake)	(*)
NEW DOWNTOWN 125i	15' - 20'	9396N (rear brake)	(*)	9395N (front brake)	(*)
NEW DOWNTOWN 350i	15' - 20'	9396N (rear brake)	(*)	9395N (front brake)	(*)
SUPERDINK 125i	09' - 21'	9396N (rear brake)	(*)	9395N (front brake)	(*)
SUPERDINK 350i	09' - 21'	9396N (rear brake)	(*)	9395N (front brake)	(*)
XCITING 400i	14' - 20'	9396N (rear brake)	(*)	9395N (front brake)	(*)
YAGER GT 125i	13' - 18'	9396N (rear brake)	(*)	9395N (front brake)	(*)
YAGER GT 300i	13' - 18'	9396N (rear brake)	(*)	9395N (front brake)	(*)

N Black

(#) With production code WB10J01 from now on.
 (#) BMW R NINE T with production code 0A6, 0A16
 (S) BMW R NINE T with a production code 0J01, 0J03
 (*) Check price with your distributor.
IMPORTANT: Indicate code color after part#. Example 0973A.

LEVERS ADAPTERS

HI-TECH PARTS

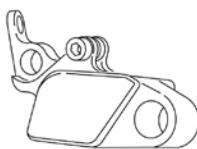
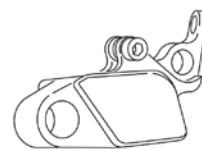

2022		For the new 2022 motorcycle models check www.puig.tv			
MODEL	YEAR	ADAPTOR CLUTCH LEVER	N	ADAPTOR BRAKE LEVER	N
SCRAMBLER	06' - 13'	5767N	(*)	5455N	(*)
SCRAMBLER 1200XC	19' - 21'	7826N	(*)	6141N	(*)
SCRAMBLER 1200XE	19' - 21'	7826N	(*)	6141N	(*)
SPEED FOUR	05' - 06'	5767N	(*)	5455N	(*)
SPEEDMASTER	05' - 17'	5767N	(*)	5455N	(*)
SPEED TRIPLE axial.	05' - 08'	5767N	(*)	5455N	(*)
SPEED TRIPLE radial.	08' - 10'	5767N	(*)	5458N	(*)
SPEED TRIPLE	11' - 15'	5767N	(*)	6141N	(*)
SPEED TRIPLE R	12' - 15'	5767N	(*)	6141N	(*)
SPEED TRIPLE/R	16' - 20'	7826N	(*)	6141N	(*)
SPEED TWIN	19' - 21'	7826N	(*)	6141N	(*)
SPRINT ST 1050	05' - 10'	5767N	(*)	5455N	(*)
STREET CUP	17' - 20'	7826N	(*)	5455N	(*)
STREET SCRAMBLER	17' - 21'	7826N	(*)	5455N	(*)
STREET TRIPLE	08' - 16'	5767N	(*)	5455N	(*)
STREET TRIPLE R	09' - 16'	5767N	(*)	5458N	(*)
STREET TRIPLE/R	17' - 19'	7826N	(*)	6141N	(*)
STREET TRIPLE R	20'	7826N	(*)	5455N	(*)
STREET TRIPLE S	17' - 19'	7826N	(*)	5455N	(*)
STREET TRIPLE RS	20' - 21'	7826N	(*)	20552N	(*)
STREET TWIN	16' - 19'	7826N	(*)	5455N	(*)
THRUXTON	04' - 15'	5767N	(*)	5455N	(*)
THRUXTON 1200	16' - 20'	7826N	(*)	5455N	(*)
THRUXTON 1200 R	16' - 20'	7826N	(*)	6141N	(*)
THRUXTON 1200 RS	20' - 21'	7826N	(*)	6141N	(*)
TRIDENT 660	21'	7826N	(*)	5455N	(*)
TIGER 800	11' - 14'	5767N	(*)	5455N	(*)
TIGER 800 XC	11' - 14'	5767N	(*)	5455N	(*)
TIGER 800 XC/XCX/XCA	15' - 20'	7826N	(*)	5455N	(*)
TIGER 800 XR/XRX/XRT	15' - 20'	7826N	(*)	5455N	(*)
TIGER 900	20' - 21'	7826N	(*)	20385N	(*)
TIGER 900 GT	20' - 21'	7826N	(*)	20385N	(*)
TIGER 900 GT LOW	20' - 21'	7826N	(*)	20385N	(*)
TIGER 900 GT PRO	20' - 21'	7826N	(*)	20385N	(*)
TIGER 900 RALLY	20' - 21'	7826N	(*)	20385N	(*)
TIGER 900 RALLY PRO	20' - 21'	7826N	(*)	20385N	(*)
TIGER 1050	07' - 13'	5767N	(*)	5455N	(*)

2022		For the new 2022 motorcycle models check www.puig.tv			
MODEL	YEAR	ADAPTOR CLUTCH LEVER	N	ADAPTOR BRAKE LEVER	N
TIGER SPORT	13' - 16'	5767N	(*)	5455N	(*)
TIGER SPORT	17' - 20'	7826N	(*)	5455N	(*)
TIGER EXPLORER	12' - 15'	6620N	(*)	5455N	(*)
TIGER EXPLORER XC	13' - 15'	6620N	(*)	5455N	(*)
TIGER EXPLORER XC/XR/XRX/XRT/XCX/XCA	16' - 20'	6620N	(*)	5455N	(*)
TIGER 1200 ALPINE	21'	6620N	(*)	5455N	(*)
TIGER 1200 DESERT	21'	6620N	(*)	5455N	(*)
YAMAHA					
FAZER8	13' - 16'	8503N	(*)	5462N	(*)
FJR1300	01' - 02'	5465N	(*)	5455N	(*)
FJR1300	03' - 05'	5465N	(*)	5462N	(*)
FJR1300A/AS	06' - 12'	5465N	(*)	5462N	(*)
FJR1300A/AS	13' - 19'	5465N	(*)	5462N	(*)
FZ1	06' - 15'	8503N	(*)	5462N	(*)
FZ1 FAZER	06' - 15'	8503N	(*)	5462N	(*)
FZ6	04' - 06'	8503N	(*)	5462N	(*)
FZ6 S2	07' - 10'	8503N	(*)	5462N	(*)
FZ6 FAZER	07' - 08'	8503N	(*)	5462N	(*)
FZ6 FAZER S2	07' - 10'	8503N	(*)	5462N	(*)
FZ8	10' - 16'	8503N	(*)	5462N	(*)
FZ8 FAZER	10' - 12'	8503N	(*)	5462N	(*)
FZS1000 FAZER	01' - 05'	8503N	(*)	5455N	(*)
MT-125	14' - 19'	6120N	(*)	7582N	(*)
MT-125	20' - 21'	6120N	(*)	3886N	(*)
MT-01	05' - 13'	5465N	(*)	5464N	(*)
MT-03	16' - 21'	7830N	(*)	7861N	(*)
MT-07	14' - 21'	8503N	(*)	5462N	(*)
MT-07 TRACER	16' - 21'	8503N	(*)	5462N	(*)
MT-07 TRACER GT	19' - 21'	8503N	(*)	5462N	(*)
MT-09	13' - 16'	8503N	(*)	5462N	(*)
MT-09	17' - 20'	8503N	(*)	5462N	(*)
MT-09	21'	8503N	(*)	7860N	(*)
MT-09 SP	18' - 20'	8503N	(*)	5462N	(*)
MT-09 SP	21'	8873N	(*)	7860N	(*)
MT-09 TRACER	15' - 17'	8873N	(*)	5462N	(*)
MT-09 TRACER	18' - 20'	8873N	(*)	5462N	(*)
MT-09 TRACER GT	18' - 20'	8873N	(*)	5462N	(*)
MT-09 TRACER	21'	8873N	(*)	7860N	(*)
MT-09 TRACER GT	21'	8873N	(*)	7860N	(*)
MT-10	16' - 21'	8873N	(*)	5462N	(*)

N Black

(#) With production code WB10J01 from now on.
 (#) BMW R NINE T with production code 0A6, 0A16
 (S) BMW R NINE T with a production code 0J01, 0J03
 (*) Check price with your distributor.

IMPORTANT: Indicate code color after part#. Example 0973A.

LEVERS ADAPTERS

HI-TECH PARTS

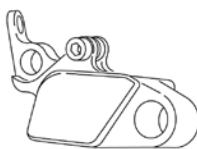
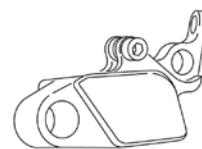

2022		For the new 2022 motorcycle models check www.puig.tv			
MODEL	YEAR	ADAPTOR CLUTCH LEVER	N	ADAPTOR BRAKE LEVER	N
MT-10 SP	17' - 21'	8873N	(*)	5462N	(*)
NIKEN	18' - 21'	8873N	(*)	5462N	(*)
TENERE 700	19' - 21'	8503N	(*)	5462N	(*)
T-MAX 500	08' - 11'	5976N (rear brake)	(*)	5462N (front brake)	(*)
T-MAX 530	12' - 14'	5976N (rear brake)	(*)	5462N (front brake)	(*)
T-MAX 530	15' - 16'	5976N (rear brake)	(*)	5462N (front brake)	(*)
T-MAX 530/DX/SX	17' - 19'	5976N (rear brake)	(*)	5462N (front brake)	(*)
T-MAX 560 /SX/DX/MAX TECH	20' - 21'	5976N (rear brake)	(*)	5462N (front brake)	(*)
VMAX Bomba Nisin	09' - 19'	5465N	(*)	5464N	(*)
X-MAX 125	18' - 21'	9493N (rear brake)	(*)	7861N (front brake)	(*)
X-MAX 300	17' - 21'	9493N (rear brake)	(*)	7861N (front brake)	(*)
X-MAX 400	13' - 21'	7000N (rear brake)	(*)	7001N (front brake)	(*)
XJ6	09' - 16'	8503N	(*)	5462N	(*)
XJ6 DIVERSION	09' - 16'	8503N	(*)	5462N	(*)
XJ6 DIVERSION F	10' - 16'	8503N	(*)	5462N	(*)
XJR1200	94' - 98'	5465N	(*)	5455N	(*)
XJR1300	04' - 16'	5465N	(*)	5462N	(*)
XSR 125	21'	6120N	(*)	3886N	(*)
XSR700	16' - 21'	8503N	(*)	5462N	(*)
XSR700 XTRIBUTE	19' - 21'	8503N	(*)	5462N	(*)
XSR900	16' - 21'	8503N	(*)	5462N	(*)
XT660R	04' - 16'	5855N	(*)	5854N	(*)
XT660X	04' - 16'	5855N	(*)	5854N	(*)
XT660Z TÉNÉRÉ	08' - 16'	6120N	(*)	5462N	(*)
XT1200Z SUPER TÉNÉRÉ	10' - 21'	5465N	(*)	5462N	(*)
XT1200ZE SUPER TENERE	19' - 21'	5465N	(*)	5462N	(*)
YZF-R125	14' - 21'	6120N	(*)	7582N	(*)
YZF-R1	99' - 01'	8503N	(*)	6609N	(*)
YZF-R1	02' - 03'	8503N	(*)	5455N	(*)
YZF-R1	04' - 08'	8503N	(*)	5464N	(*)
YZF-R1	09' - 14'	8503N	(*)	5768N	(*)
YZF-R1	15' - 21'	8503N	(*)	7860N	(*)
YZF-R1M	17' - 21'	8503N	(*)	7860N	(*)
YZF-R3	15' - 18'	7830N	(*)	7861N	(*)
YZF-R3	19' - 21'	7830N	(*)	20521N	(*)
YZF-R6	99' - 05'	8503N	(*)	5455N	(*)
YZF-R6 Bomba Radial	05'	8503N	(*)	5464N	(*)

2022		For the new 2022 motorcycle models check www.puig.tv			
MODEL	YEAR	ADAPTOR CLUTCH LEVER	N	ADAPTOR BRAKE LEVER	N
YZF-R6	06' - 16'	8503N	(*)	5464N	(*)
YZF-R6	17' - 20'	8503N	(*)	7860N	(*)

 N Black

(#) With production code WB10J01 from now on.
 (#) BMW R NINE T with production code 0A6, 0A16
 (S) BMW R NINE T with a production code 0J01, 0J03
 (*) Check price with your distributor.

IMPORTANT: Indicate code color after part#. Example 0973A.

THERMAL GLOVES ANTI-VIBRATION

HI-TECH PARTS | TECHNICAL SECTION



REF. 7778R

MODEL	REF.	R	A	N
THERMAL GLOVES ANTI-VIBRATION BY PAIR C/BLACK	7778N			(*)
THERMAL GLOVES ANTI-VIBRATION BY PAIR C/RED	7778R			(*)
THERMAL GLOVES ANTI-VIBRATION BY PAIR C/BLUE	7778A			(*)

 R Red
 A Blue

 N Black

(*) Check price with your distributor.
 IMPORTANT: Indicate code color after part#. Example 0973A.



BRAKE / CLUTCH LEVER PROTECTOR

HI-TECH PARTS | TECHNICAL SECTION

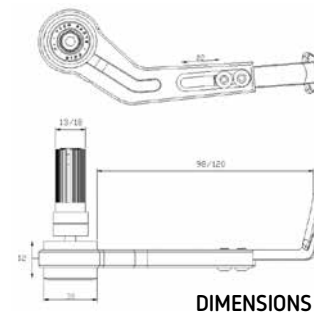

DIMENSIONS

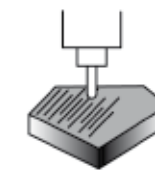

CNC MACHINED
Machined from billet aluminium and anodized in different colors.



ADJUSTABLE

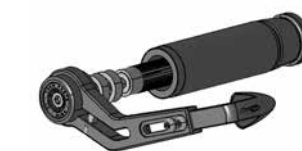

ADAPTABLE
Specific available adapters for bike model.

Universal models for handlebars diameters between 13-18 mm.



REF. 37650

MODEL	REF.	R O A T N P V
BRAKE LEVER PROTECTOR UNIVERSAL 13-18 mm. DIAMETER	3765	(*)
CLUTCH LEVER PROTECTOR UNIVERSAL 13-18 mm. DIAMETER	3877	(*)

SPARES	REF.	R O A T N P V
TIP PROTECTOR FOR BRAKE LEVER - SPARE	3766	(*)
END TIP PROTECTOR CLUTCH LEVER - SPARE	3878	(*)

FOR MODELS THAT REQUIRE ADAPTERS SEE PAGE 230.
REFERENCES FOR BARENDS ON THE CLUTCH SIDE TO MATCH THE BAREND USED WITH THE BRAKE LEVER PROTECTOR SEE PAGE 230.

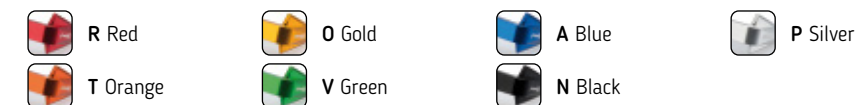

(*) Check price with your distributor.
IMPORTANT: Indicate code color after part#. Example 0973A.

BRAKE / CLUTCH LEVER PROTECTOR ADAPTORS

HI-TECH PARTS



2022		For the new 2022 motorcycle models check www.puig.tv				
MODEL	YEAR	ADAPTOR REF.	N	LEFT SIDE BAR END REF.	N	
APRILIA						
RSV4 RF/RR	15' - 20'	3807N	(*)	3810N	(*)	
RS 660	21'	20616N	(*)	20616N	(*)	
SHIVER 900	17' - 21'	9871N	(*)	9871N	(*)	
TUONO 660	21'	9871N	(*)	9871N	(*)	
TUONO V4 1100 FACTORY	15' - 20'	3159N	(*)	3811N	(*)	
BENELLI						
LEONCINO 250	20' - 21'	9699N	(*)	9699N	(*)	
LEONCINO 500	16' - 21'	9699N	(*)	9699N	(*)	
BMW						
C600 SPORT	12' - 15'	9580N	(*)	9580N	(*)	
C650 SPORT	16' - 20'	9580N	(*)	9580N	(*)	
F800 R	09' - 14'	9587N	(*)	9587N	(*)	
F800 R	15' - 20'	9581N	(*)	9581N	(*)	
F900 R	20' - 21'	9990N	(*)	9990N	(*)	
G310GS	21'	9850N	(*)	9850N	(*)	
G310 R	16' - 21'	9850N	(*)	9850N	(*)	
R1200 R	09' - 18'	9990N	(*)	9990N	(*)	
R1200 RS	15' - 18'	20352N	(*)	20352N	(*)	
R1250 RS	19' - 21'	20352N	(*)	20352N	(*)	
R NINE T/SCRAMBLER/PURE/URBAN G/S	20'	9581N	(*)	9581N	(*)	
S1000 R	14' - 20'	9581N	(*)	9581N	(*)	
S1000 R	21'	9990N	(*)	9990N	(*)	
S1000RR	15' - 18'	9581N	(*)	9581N	(*)	
S1000RR	19' - 21'	3776N	(*)	3776N	(*)	
DUCATI						
959 PANIGALE	16' - 19'	20426N	(*)	20426N	(*)	
959 PANIGALE CORSE	18' - 19'	20426N	(*)	20426N	(*)	
1199 PANIGALE	12' - 14'	UNIVERSAL - IT DOES NOT REQUIRE ADAPTOR		3770N	(*)	
1199 PANIGALE R	15' - 17'	UNIVERSAL - IT DOES NOT REQUIRE ADAPTOR		3770N	(*)	
1299 PANIGALE/S	15' - 17'	UNIVERSAL - IT DOES NOT REQUIRE ADAPTOR		3770N	(*)	
DIAVEL 1260/S	19' - 21'	UNIVERSAL - IT DOES NOT REQUIRE ADAPTOR		3770N	(*)	
MONSTER 797	17' - 20'	UNIVERSAL - IT DOES NOT REQUIRE ADAPTOR		3770N	(*)	
MONSTER 821	14' - 20'	UNIVERSAL - IT DOES NOT REQUIRE ADAPTOR		3770N	(*)	
MONSTER 937	21'	9427N	(*)	3774N	(*)	

2022

For the new 2022 motorcycle models check www.puig.tv

MODEL	YEAR	ADAPTOR REF.	N	LEFT SIDE BAR END REF.	N
MONSTER 937 PLUS	21'	9427N	(*)	3774N	(*)
MONSTER 1200 R	16' - 20'	UNIVERSAL - IT DOES NOT REQUIRE ADAPTOR		3770N	(*)
MONSTER 1200/S	17' - 21'	UNIVERSAL - IT DOES NOT REQUIRE ADAPTOR		3770N	(*)
PANIGALE V2	20' - 21'	20426N	(*)	20426N	(*)
PANIGALE V2 BAYLISS	21'	20426N	(*)	20426N	(*)
PANIGALE 1100 V4/S	18' - 21'	20426N	(*)	20426N	(*)
PANIGALE 1100 V4 SP	21'	20426N	(*)	20426N	(*)
SCRAMBLER 1100	18' - 21'	UNIVERSAL - IT DOES NOT REQUIRE ADAPTOR		3770N	(*)
SCRAMBLER 1100 SPORT	18' - 21'	UNIVERSAL - IT DOES NOT REQUIRE ADAPTOR		3770N	(*)
SCRAMBLER 1100 SPECIAL	18' - 21'	UNIVERSAL - IT DOES NOT REQUIRE ADAPTOR		3770N	(*)
SCRAMBLER DESERT SLED	17' - 20'	UNIVERSAL - IT DOES NOT REQUIRE ADAPTOR		3770N	(*)
SCRAMBLER FLAT TRACK PRO	16'	UNIVERSAL - IT DOES NOT REQUIRE ADAPTOR		3770N	(*)
SCRAMBLER ICON/CLASSIC/FULL THROTTLE	15' - 21'	UNIVERSAL - IT DOES NOT REQUIRE ADAPTOR		3770N	(*)
SCRAMBLER SIXTY2	16' - 21'	UNIVERSAL - IT DOES NOT REQUIRE ADAPTOR		3770N	(*)
SCRAMBLER URBAN ENDURO	15' - 16'	UNIVERSAL - IT DOES NOT REQUIRE ADAPTOR		3770N	(*)
STREETFIGHTER V4/S	20' - 21'	UNIVERSAL - IT DOES NOT REQUIRE ADAPTOR		3770N	(*)
SUPERSPORT 939/S	17' - 20'	UNIVERSAL - IT DOES NOT REQUIRE ADAPTOR		3770N	(*)
SUPERSPORT 950/S	21'	UNIVERSAL - IT DOES NOT REQUIRE ADAPTOR		3770N	(*)
X DIAVEL	16' - 21'	UNIVERSAL - IT DOES NOT REQUIRE ADAPTOR		3770N	(*)
HARLEY DAVIDSON					
SPORTSTER 883 IRON (XL883N)	09'-13'	9662N	(*)	3777N	(*)
SPORTSTER 883 IRON (XL883N)	14'-16'	9662N	(*)	3777N	(*)
SPORTSTER 883 IRON (XL883N/17)	17' - 20'	9662N	(*)	3777N	(*)
SPORTSTER 883 SUPERLOW (XL883L)	11' - 13'	9662N	(*)	3777N	(*)
SPORTSTER 883 SUPERLOW (XL883L)	14' - 16'	9662N	(*)	3777N	(*)
SPORTSTER 883 SUPERLOW (XL883L/17)	17' - 20'	9662N	(*)	3777N	(*)
SPORTSTER 883R ROADSTER (XL883R/06)	06'-13'	9662N	(*)	3777N	(*)
SPORTSTER 883R ROADSTER (XL883R/06)	14' - 20'	9662N	(*)	3777N	(*)
SPORTSTER 1200 CUSTOM (XL1200C/11)	11'-13'	9662N	(*)	3777N	(*)
SPORTSTER 1200 CUSTOM (XL1200C/11)	14'-16'	9662N	(*)	3777N	(*)
SPORTSTER 1200 CUSTOM (XL1200C/17)	17' - 20'	9662N	(*)	3777N	(*)
SPORTSTER 1200 SUPER LOW (XL1200T)	17' - 20'	9662N	(*)	3777N	(*)
SPORTSTER 1200 SUPER LOW (XL1200T/17)	17' - 20'	9662N	(*)	3777N	(*)
SPORTSTER 1200 ROADSTER (XL1200CX)	16' - 20'	9662N	(*)	3777N	(*)
HONDA					
CB125F	15' - 20'	UNIVERSAL - IT DOES NOT REQUIRE ADAPTOR		3770N	(*)
CB125R NEO SPORTS CAFE	18' - 21'	UNIVERSAL - IT DOES NOT REQUIRE ADAPTOR		3770N	(*)
CB300R NEO SPORTS CAFE	18' - 21'	UNIVERSAL - IT DOES NOT REQUIRE ADAPTOR		3770N	(*)
CB650R NEO SPORTS CAFE	19' - 21'	UNIVERSAL - IT DOES NOT REQUIRE ADAPTOR		3770N	(*)
CB1000R NEO SPORTS CAFE	18' - 21'	UNIVERSAL - IT DOES NOT REQUIRE ADAPTOR		3770N	(*)

N Black

(*) Check price with your distributor.

IMPORTANT: Indicate code color after part#. Example 0973A.

BRAKE / CLUTCH LEVER PROTECTOR ADAPTORS

HI-TECH PARTS



2022		For the new 2022 motorcycle models check www.puig.tv				
MODEL	YEAR	ADAPTOR REF.	N	LEFT SIDE BAR END REF.	N	
CB1000R BLACK EDITION	21'	UNIVERSAL - IT DOES NOT REQUIRE ADAPTOR		3770N	(*)	
CB500	93' - 04'	UNIVERSAL - IT DOES NOT REQUIRE ADAPTOR		3770N	(*)	
CB500F	13' - 21'	UNIVERSAL - IT DOES NOT REQUIRE ADAPTOR		3770N	(*)	
CB500X	13' - 21'	UNIVERSAL - IT DOES NOT REQUIRE ADAPTOR		3770N	(*)	
CB600F HORNET	98' - 15'	UNIVERSAL - IT DOES NOT REQUIRE ADAPTOR		3770N	(*)	
CB650F	14' - 20'	UNIVERSAL - IT DOES NOT REQUIRE ADAPTOR		3770N	(*)	
CB750	93' - 03'	UNIVERSAL - IT DOES NOT REQUIRE ADAPTOR		3770N	(*)	
CB900F HORNET	02' - 05'	UNIVERSAL - IT DOES NOT REQUIRE ADAPTOR		3770N	(*)	
CB1000R	08' - 16'	UNIVERSAL - IT DOES NOT REQUIRE ADAPTOR		3770N	(*)	
CB1100EX	14' - 21'	UNIVERSAL - IT DOES NOT REQUIRE ADAPTOR		3770N	(*)	
CB1100RS	17' - 21'	UNIVERSAL - IT DOES NOT REQUIRE ADAPTOR		3770N	(*)	
CB1300	03'	UNIVERSAL - IT DOES NOT REQUIRE ADAPTOR		3770N	(*)	
CBF250	04' - 16'	UNIVERSAL - IT DOES NOT REQUIRE ADAPTOR		3770N	(*)	
CBF500	04' - 07'	UNIVERSAL - IT DOES NOT REQUIRE ADAPTOR		3770N	(*)	
CBF600	04' - 14'	UNIVERSAL - IT DOES NOT REQUIRE ADAPTOR		3770N	(*)	
CBF600S	08' - 14'	UNIVERSAL - IT DOES NOT REQUIRE ADAPTOR		3770N	(*)	
CBF1000	06' - 11'	UNIVERSAL - IT DOES NOT REQUIRE ADAPTOR		3770N	(*)	
CBR125R	11' - 16'	UNIVERSAL - IT DOES NOT REQUIRE ADAPTOR		3770N	(*)	
CBR250R	11' - 15'	UNIVERSAL - IT DOES NOT REQUIRE ADAPTOR		3770N	(*)	
CBR500R	13' - 21'	UNIVERSAL - IT DOES NOT REQUIRE ADAPTOR		3770N	(*)	
CBR600RR	03' - 16'	UNIVERSAL - IT DOES NOT REQUIRE ADAPTOR		3770N	(*)	
CBR600F	99' - 07'	UNIVERSAL - IT DOES NOT REQUIRE ADAPTOR		3770N	(*)	
CBR600F	11' - 13'	UNIVERSAL - IT DOES NOT REQUIRE ADAPTOR		3770N	(*)	
CBR650F	14' - 19'	UNIVERSAL - IT DOES NOT REQUIRE ADAPTOR		3770N	(*)	
CBR650R	19' - 21'	UNIVERSAL - IT DOES NOT REQUIRE ADAPTOR		3770N	(*)	
CBR900RR FIREBLADE	00' - 03'	UNIVERSAL - IT DOES NOT REQUIRE ADAPTOR		3770N	(*)	
CBR1000RR FIREBLADE	04' - 13'	UNIVERSAL - IT DOES NOT REQUIRE ADAPTOR		3770N	(*)	
CBR1000RR FIREBLADE /SP	14' - 16'	UNIVERSAL - IT DOES NOT REQUIRE ADAPTOR		3770N	(*)	
CBR1000RR FIREBLADE/SP/SP2	17' - 19'	UNIVERSAL - IT DOES NOT REQUIRE ADAPTOR		3770N	(*)	
CBR1000RR FIREBLADE /SP	20' - 21'	UNIVERSAL - IT DOES NOT REQUIRE ADAPTOR		3770N	(*)	
CBR1000F	94' - 00'	UNIVERSAL - IT DOES NOT REQUIRE ADAPTOR		3770N	(*)	
CBR1100XX BLACKBIRD	97' - 07'	UNIVERSAL - IT DOES NOT REQUIRE ADAPTOR		3770N	(*)	
CROSSRUNNER	15' - 21'	UNIVERSAL - IT DOES NOT REQUIRE ADAPTOR		3770N	(*)	
FORZA 750	21'	UNIVERSAL - IT DOES NOT REQUIRE ADAPTOR		3770N	(*)	
INTEGRA 700	12' - 13'	UNIVERSAL - IT DOES NOT REQUIRE ADAPTOR		3770N	(*)	

2022		For the new 2022 motorcycle models check www.puig.tv				
MODEL	YEAR	ADAPTOR REF.	N	LEFT SIDE BAR END REF.	N	
INTEGRA 750	14' - 15'	UNIVERSAL - IT DOES NOT REQUIRE ADAPTOR		3770N	(*)	
INTEGRA 750S	14' - 15'	UNIVERSAL - IT DOES NOT REQUIRE ADAPTOR		3770N	(*)	
INTEGRA 750S	16' - 19'	UNIVERSAL - IT DOES NOT REQUIRE ADAPTOR		3770N	(*)	
MSX125	14' - 20'	UNIVERSAL - IT DOES NOT REQUIRE ADAPTOR		3770N	(*)	
NC700S/X	12' - 13'	UNIVERSAL - IT DOES NOT REQUIRE ADAPTOR		3770N	(*)	
NC750S/X	14' - 15'	UNIVERSAL - IT DOES NOT REQUIRE ADAPTOR		3770N	(*)	
NC750S/X	16' - 21'	UNIVERSAL - IT DOES NOT REQUIRE ADAPTOR		3770N	(*)	
PCX 125	10' - 20'	UNIVERSAL - IT DOES NOT REQUIRE ADAPTOR		3770N	(*)	
VFR800F	14' - 18'	UNIVERSAL - IT DOES NOT REQUIRE ADAPTOR		3770N	(*)	
VFR1200F	10' - 16'	UNIVERSAL - IT DOES NOT REQUIRE ADAPTOR		3770N	(*)	
VTR1000F FIRE STORM	97' - 07'	UNIVERSAL - IT DOES NOT REQUIRE ADAPTOR		3770N	(*)	
X-ELEVEN	99' - 03'	UNIVERSAL - IT DOES NOT REQUIRE ADAPTOR		3770N	(*)	
HUSQVARNA						
SVARTPILEN 401	17' - 21'	20577N	(*)	20577N	(*)	
VITPILEN 401	17' - 21'	20577N	(*)	20577N	(*)	
INDIAN						
FTR 1200	19' - 21'	UNIVERSAL - IT DOES NOT REQUIRE ADAPTOR		3770N	(*)	
FTR 1200 S	19' - 21'	UNIVERSAL - IT DOES NOT REQUIRE ADAPTOR		3770N	(*)	
KAWASAKI						
ER-6N	05' - 16'	9584N	(*)	9584N	(*)	
ER-6F	09' - 16'	9584N	(*)	9584N	(*)	
NINJA 125	19' - 21'	9584N	(*)	9584N	(*)	
NINJA 300	13' - 17'	9584N	(*)	9584N	(*)	
NINJA 400	18' - 21'	9584N	(*)	9584N	(*)	
NINJA 650	20' - 21'	UNIVERSAL - IT DOES NOT REQUIRE ADAPTOR		3770N	(*)	
NINJA H2	15' - 21'	3809N	(*)			
NINJA H2 SX	18' - 21'	UNIVERSAL - IT DOES NOT REQUIRE ADAPTOR		3770N	(*)	
NINJA 1000 SX	20' - 21'	9584N	(*)	9584N	(*)	
VERSYS 650	07' - 21'	9584N	(*)	9584N	(*)	
VERSYS 1000	12' - 20'	9584N	(*)	9584N	(*)	
VULCAN S	15' - 21'	9584N	(*)	9584N	(*)	
VULCAN S CAFE	17' - 20'	9584N	(*)	9584N	(*)	
W800	11' - 21'	9584N	(*)	9584N	(*)	
Z125	17' - 21'	9584N	(*)	9584N	(*)	
Z300	15' - 17'	9584N	(*)	9584N	(*)	
Z400	19' - 21'	9584N	(*)	9584N	(*)	
Z650	17' - 21'	UNIVERSAL - IT DOES NOT REQUIRE ADAPTOR		3770N	(*)	
Z750	04' - 12'	9584N	(*)	9584N	(*)	
Z750R	11' - 12'	9584N	(*)	9584N	(*)	
Z800/E	13' - 16'	9584N	(*)	9584N	(*)	



(*) Check price with your distributor.

IMPORTANT: Indicate code color after part#. Example 0973A.

BRAKE / CLUTCH LEVER PROTECTOR ADAPTORS

HI-TECH PARTS



2022		For the new 2022 motorcycle models check www.puig.tv			
MODEL	YEAR	ADAPTOR REF.	N	LEFT SIDE BAR END REF.	N
Z900	17' - 21'	9584N	(*)	9584N	(*)
Z900RS	18' - 21'	9584N	(*)	9584N	(*)
Z900RS CAFÉ	18' - 21'	9584N	(*)	9584N	(*)
Z1000	03' - 21'	9584N	(*)	9584N	(*)
Z1000R	17' - 21'	9584N	(*)	9584N	(*)
Z1000SX	11' - 19'	9584N	(*)	9584N	(*)
ZH2	20' - 21'	9584N	(*)	9584N	(*)
Z H2 SE	20' - 21'	9584N	(*)	9584N	(*)
ZR7	99' - 03'	9584N	(*)	9584N	(*)
ZR7S	01' - 03'	9584N	(*)	9584N	(*)
ZRX1100	97' - 01'	9584N	(*)	9584N	(*)
ZRX1200S	01' - 07'	9584N	(*)	9584N	(*)
ZX-6R	99' - 06'	9584N	(*)	9584N	(*)
ZX-6R	09' - 16'	9584N	(*)	9584N	(*)
ZX-6R	18' - 21'	9584N	(*)	9584N	(*)
ZX-6R 636	13' - 21''	9584N	(*)	9584N	(*)
ZX-7R	96' - 01'	9584N	(*)	9584N	(*)
ZX-9R	94' - 04'	9584N	(*)	9584N	(*)
ZX-10R	11' - 15'	9584N	(*)	9584N	(*)
ZX-10R	16' - 21'	3778N	(*)	3778N	(*)
ZX-10RR	17' - 21'	3778N	(*)	3778N	(*)
ZX-10R SE	18' - 20'	3778N	(*)	3778N	(*)
ZX-12R	00' - 06'	9584N	(*)	9584N	(*)
ZZR600	93' - 05'	9584N	(*)	9584N	(*)
ZZR1100	93' - 01'	9584N	(*)	9584N	(*)
ZZR1400	06' - 21'	9584N	(*)	9584N	(*)
KTM					
125 DUKE	11' - 21'	UNIVERSAL - IT DOES NOT REQUIRE ADAPTOR		3770N	(*)
390 DUKE	13' - 16'	UNIVERSAL - IT DOES NOT REQUIRE ADAPTOR		3770N	(*)
690 DUKE	12' - 20'	UNIVERSAL - IT DOES NOT REQUIRE ADAPTOR		3770N	(*)
690 DUKE R	12' - 17'	UNIVERSAL - IT DOES NOT REQUIRE ADAPTOR		3770N	(*)
790 DUKE	18' - 21'	UNIVERSAL - IT DOES NOT REQUIRE ADAPTOR		3770N	(*)
890 DUKE R	20' - 21'	UNIVERSAL - IT DOES NOT REQUIRE ADAPTOR		3770N	(*)
1290 SUPERDUKE R	14' - 21'	UNIVERSAL - IT DOES NOT REQUIRE ADAPTOR		3770N	(*)
1290 SUPERDUKE GT	16' - 19'	UNIVERSAL - IT DOES NOT REQUIRE ADAPTOR		3770N	(*)

2022		For the new 2022 motorcycle models check www.puig.tv			
MODEL	YEAR	ADAPTOR REF.	N	LEFT SIDE BAR END REF.	N
RC125/390	14' - 21'	UNIVERSAL - IT DOES NOT REQUIRE ADAPTOR		3770N	(*)
KYMCO					
AK550	17' - 21'	20486N	(*)		
MV AGUSTA					
BRUTALE 1000RR	20' - 21'	UNIVERSAL - IT DOES NOT REQUIRE ADAPTOR		3770N	(*)
SUPERVELOCE	21'	UNIVERSAL - IT DOES NOT REQUIRE ADAPTOR		3770N	(*)
SUZUKI					
B-KING	08' - 11'	9582N	(*)	3774N	(*)
BURGMAN 400	17' - 21'	9582N	(*)	3774N	(*)
DL250 V-STROM	17' - 21'	9582N	(*)	3774N	(*)
DL1050 V-STROM	20' - 21'	9582N	(*)	3774N	(*)
DL1050XT V-STROM	20' - 21'	9582N	(*)	3774N	(*)
GS500	01' - 07'	9582N	(*)	3774N	(*)
GS500F	04' - 07'	9582N	(*)	3774N	(*)
GSF600 BANDIT	96' - 06'	9582N	(*)	3774N	(*)
GSF600S BANDIT	96' - 04'	9582N	(*)	3774N	(*)
GSF1200 BANDIT/S	96' - 06'	9582N	(*)	3774N	(*)
GSR600	06' - 11'	9582N	(*)	3774N	(*)
GSR750	11' - 16'	9582N	(*)	3774N	(*)
GSX-R125	17' - 21'	9582N	(*)	3774N	(*)
GSX-R250	17' - 21'	9582N	(*)	3774N	(*)
GSX-R600	96' - 05'	9582N	(*)	3774N	(*)
GSX-R600	06' - 16	9582N	(*)	3774N	(*)
GSX-R750	96' - 05'	9582N	(*)	3774N	(*)
GSX-R1000	01' - 16'	9582N	(*)	3774N	(*)
GSX-R1000/R	17' - 20'	3804N	(*)	3805N	(*)
GSX-S750	17' - 21'	9427N	(*)	3774N	(*)
GSX-S950	22'	9582N	(*)		
GSX-S1000	15' - 22'	9582N	(*)	3774N	(*)
GSX-S1000F	15' - 21'	9582N	(*)	3774N	(*)
GSX750F	92' - 97'	9582N	(*)	3774N	(*)
GSX1200	99' - 00'	9582N	(*)	3774N	(*)
GSX1400	01' - 06'	9582N	(*)	3774N	(*)
INAZUMA	13' - 17'	9582N	(*)	3774N	(*)
KATANA	19' - 21'	9582N	(*)	3774N	(*)
SFV650 GLADIUS	09' - 15'	9582N	(*)	3774N	(*)
SV650	05' - 08'	9582N	(*)	3774N	(*)
SV650S	03' - 08'	9582N	(*)	3774N	(*)
SV650	16' - 21'	9582N	(*)	3774N	(*)
SV650X	18' - 21'	9582N	(*)	3774N	(*)

N Black

(*) Check price with your distributor.
IMPORTANT: Indicate code color after part#. Example 0973A.

BRAKE / CLUTCH LEVER PROTECTOR ADAPTORS

HI-TECH PARTS



2022		For the new 2022 motorcycle models check www.puig.tv				
MODEL	YEAR	ADAPTOR REF.	N	LEFT SIDE BAR END REF.	N	
SV1000/S	03' - 05'	9582N	(*)	3774N	(*)	
TL1000R	98' - 99'	9582N	(*)	3774N	(*)	
TL1000S	97' - 00'	9582N	(*)	3774N	(*)	
TRIUMPH						
BONNEVILLE T100	16' - 19'	9500N	(*)	9500N	(*)	
BONNEVILLE T120	16' - 19'	9500N	(*)	9500N	(*)	
SCRAMBLER 1200XC	19' - 21'	9500N	(*)	9500N	(*)	
SCRAMBLER 1200XE	19' - 21'	9500N	(*)	9500N	(*)	
STREET SCRAMBLER	17' - 21'	9500N	(*)	9500N	(*)	
STREET TWIN	16' - 21'	9500N	(*)	9500N	(*)	
TRIDENT 660	21'	9500N	(*)	9500N	(*)	
YAMAHA						
FZ6	04' - 08'	9583P	(*)	3771N	(*)	
MT-125	14' - 21'	9583P	(*)	3771N	(*)	
MT-03	16' - 19'	20310N	(*)	20311N	(*)	
MT-03	20' - 21'	20310N	(*)	20311N	(*)	
MT-07	14' - 21'	9583P	(*)	3771N	(*)	
MT-09	13' - 20'	9583P	(*)	3771N	(*)	
MT-09	21'	3800N	(*)	3800N	(*)	
MT-09 SP	18' - 20'	9583P	(*)	3771N	(*)	
MT-09 SP	21'	3800N	(*)	3800N	(*)	
MT-10	16' - 21'	9583P	(*)	3771N	(*)	
MT-10 SP	17' - 21'	9583P	(*)	3771N	(*)	
TDM 900	03' - 13'	9583P	(*)	3771N	(*)	
T-MAX 530	12' - 16'	9583P	(*)	3771N	(*)	
T-MAX 530/DX/SX	17' - 19'	9583P	(*)	3771N	(*)	
T.MAX 560 /SX/DX/MAX TECH	20' - 21'	9583P	(*)	3771N	(*)	
XJ6	09' - 16'	9583P	(*)	3771N	(*)	
XJR1300	99' - 13'	9583P	(*)	3771N	(*)	
X-MAX 125 (M16)	10' - 16'	9583P	(*)	3771N	(*)	
X-MAX 250 (M16)	10' - 16'	9583P	(*)	3771N	(*)	
X-MAX 400	13' - 21'	9583P	(*)	3771N	(*)	
XSR 125	21'	UNIVERSAL - IT DOES NOT REQUIRE ADAPTOR		3770N	(*)	
XSR700	16' - 21'	9583P	(*)	3771N	(*)	
XSR700 XTRIBUTE	19' - 21'	9583P	(*)	3771N	(*)	

2022		For the new 2022 motorcycle models check www.puig.tv				
MODEL	YEAR	ADAPTOR REF.	N	LEFT SIDE BAR END REF.	N	
XSR900	16' - 21'	9583P	(*)	3771N	(*)	
YZF-R1	98' - 14'	3800N	(*)	3800N	(*)	
YZF-R1	15' - 21'	3801N	(*)	3801N	(*)	
YFZ-R1 M	17' - 21'	3801N	(*)	3801N	(*)	
YZF-R3	15' - 21'	UNIVERSAL - IT DOES NOT REQUIRE ADAPTOR		3770N	(*)	
YZF-R6	06' - 16'	3800N	(*)	3800N	(*)	
YZF-R6	17' - 20'	3801N	(*)	3801N	(*)	

 N Black

(*) Check price with your distributor.
IMPORTANT: Indicate code color after part#. Example 0973A.



SCOOTER LEVERS

HI-TECH PARTS | TECHNICAL SECTION

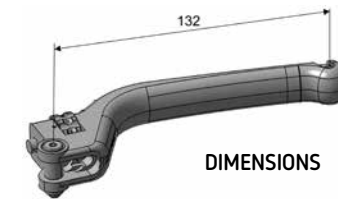

DIMENSIONS

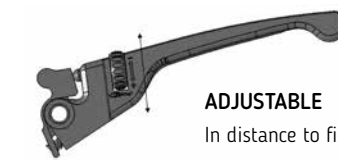

ADJUSTABLE
In distance to fist.

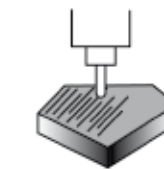

CNC MACHINED
Machined from billet aluminium and anodized in different colors.



MODEL	YEAR	FRONT BRAKE LEVER	A N P R T O V	REAR BRAKE LEVER	A N P R T O V
HONDA					
FORZA 125	20'	20394	(*)	20751	(*)
SCOOPHY SH125i	17' - 21'	20394	(*)	20751	(*)
SCOOPY SH150i	17' - 20'	20394	(*)	20751	(*)
SCOOPY SH300i	15' - 21'	20394	(*)	20751	(*)

MODEL	YEAR	FRONT BRAKE LEVER	N P	REAR BRAKE LEVER	N P
PIAGGIO					
VESPA GTS125	08' - 20'	20366	(*)	20366	(*)
VESPA GTS300	08' - 20'	20366	(*)	20366	(*)

NOTE: ADAPTORS INCLUDED WHEN REQUESTING THE LEVER REFERENCE.
(*) Check price with your distributor.
IMPORTANT: Indicate code color after part#. Example 0973A.



HERITAGE LEVERS

HI-TECH PARTS | TECHNICAL SECTION

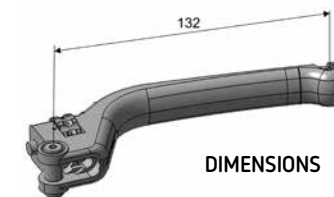

DIMENSIONS



ADJUSTABLE

In distance to fist.

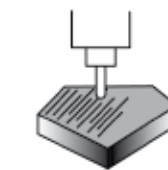

CNC MACHINED

Machined from billet aluminium and anodized in different colors.



100gr.



REF. 9995N

NON-FOLDABLE MODEL	REF.	N
UNFOLDABLE BRAKE LEVER	9995N	(*)
HANDRAIL BRAKE HANDLE	SEE CHART BELOW	
UNFOLDABLE CLUTCH LEVER	9996N	(*)
ADAPTOR CLUTCH LEVER	SEE CHART BELOW	

MODEL	YEAR	CLUTCH LEVER ADAPTER	N	BRAKE LEVER ADAPTER	N
HARLEY DAVIDSON					
SPORTSTER 883 IRON	16' - 20'	9645N	(*)	9648N	(*)
HONDA					
CMX 500 REBEL	17' - 21'	9649N	(*)	9646N	(*)
CMX 500 REBEL S	20' - 21'	9649N	(*)	9646N	(*)
CMX 1100 REBEL	21'	20262N	(*)	20263N	(*)
INDIAN					
SCOUT	15' - 21'	9742N	(*)	9743N	(*)
SCOUT BOBBER	18' - 21'	9742N	(*)	9743N	(*)
KAWASAKI					
VULCAN S	15' - 21'	9642N	(*)	9647N	(*)
VULCAN S CAFE	17' - 20'	9642N	(*)	9647N	(*)
TRIUMPH					
BONNEVILLE BOBBER	17' - 21'	9643N	(*)	9650N	(*)
BONNEVILLE BOBBER BLACK	20' - 21'	9643N	(*)	9650N	(*)
YAMAHA					
SCR 950	17' - 21'	0391N	(*)	1000N	(*)
XV950	14' - 21'	9644N	(*)	9651N	(*)
XV950R	14' - 21'	9644N	(*)	9651N	(*)
XV950 RACER	14' - 21'	0391N	(*)	1000N	(*)



N Black

(*) Check price with your distributor.
IMPORTANT: Indicate code color after part#. Example 0973A.



OFF-ROAD LEVERS

HI-TECH PARTS | TECHNICAL SECTION

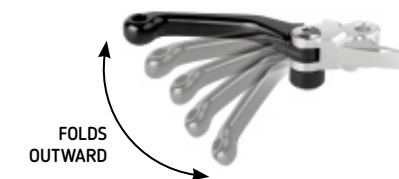

FOLDS OUTWARD

Adaptor designed with spring which allows the lever to swing forward to avoid the lever to twist or break.

DESIGN

Exclusive design: Clutch lever - length of lever for 4 fingers. Brake lever - length for 3 fingers.

REGULATION

The adjustable system allows to adjust the position for rider's needs.



1 REF. 20018N



2 REF. 20002N



OFF-ROAD MODEL	REF.
BRAKE LEVER WITH ADAPTOR (1)	SEE PAGE 244
HANDLE CLUTCH WITH HARDWARE (2)	SEE PAGE 244

SPARES	REF.	N
BRAKE LEVER	88888N	(*)
CLUTCH LEVER	99999N	(*)

(*) Check price with your distributor.
IMPORTANT: Indicate code color after part#. Example 0973A.

OFF-ROAD LEVERS

HI-TECH PARTS

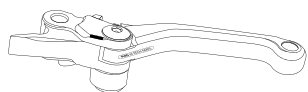
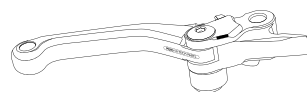

2022		For the new 2022 motorcycle models check www.puig.tv				
MODEL	YEAR	CLUTCH LEVER + ADAPTOR	N	BRAKE LEVER + ADAPTOR	N	
BETA						
RR 2T	13'-19'	20012N	(*)	20018N	(*)	
RR 4T	12'-19'	20012N	(*)	20018N	(*)	
RS 4T	12'-19'	20012N	(*)	20018N	(*)	
X-TRAINER	15'-18'	20012N	(*)	20018N	(*)	
GAS GAS						
EC 2T	00'-16'	20043N	(*)	20018N	(*)	
EC 4T	10'-13'	20043N	(*)	20018N	(*)	
EC250 E4	17'	20013N	(*)	20018N	(*)	
EC250	21'	20710N	(*)	20711N	(*)	
EC300 E4	17'	20013N	(*)	20018N	(*)	
EC300	21'	20710N	(*)	20711N	(*)	
FSE	03'-09'	20043N	(*)	20018N	(*)	
FSR	03'-09'	20043N	(*)	20018N	(*)	
XC250	17'	20013N	(*)	20018N	(*)	
XC300	17'	20013N	(*)	20018N	(*)	
HONDA						
CR80R	98'-07'	20001N	(*)	20018N	(*)	
CR85R	98'-07'	20001N	(*)	20018N	(*)	
CR125R	92'-03'	20001N	(*)	20018N	(*)	
CR125R	04'-07'	20002N	(*)	20018N	(*)	
CR250R	92'-03'	20001N	(*)	20018N	(*)	
CR250R	04'-07'	20002N	(*)	20018N	(*)	
CRF150F	03'-17'	20003N	(*)	20018N	(*)	
CRF150R	07'-21'	20001N	(*)	20018N	(*)	
CRF230F	03'-17'	20003N	(*)	20018N	(*)	
CRF250F	19'-21'	20003N	(*)	20018N	(*)	
CRF250R	04'-06'	20002N	(*)	20018N	(*)	
CRF250R	07'-21'	20002N	(*)	20019N	(*)	
CRF250RX	19' - 21'	20002N	(*)	20018N	(*)	
CRF250X	04'-17'	20002N	(*)	20018N	(*)	
CRF450R	02'-03'	20001N	(*)	20018N	(*)	
CRF450R	04'-06'	20002N	(*)	20018N	(*)	
CRF450R	07'-20'	20002N	(*)	20019N	(*)	
CRF450R	21'	20650N	(*)	20019N	(*)	
CRF450RX	17'-20'	20002N	(*)	20019N	(*)	
CRF450RX	21'	20650N	(*)	20019N	(*)	
CRF450X	05'-17'	20002N	(*)	20018N	(*)	
XR650L	93'-21'	20708N	(*)	20709N	(*)	

2022		For the new 2022 motorcycle models check www.puig.tv			
MODEL	YEAR	CLUTCH LEVER + ADAPTOR	N	BRAKE LEVER + ADAPTOR	N
HUSQVARNA					
FC250	14'-15'	20012N	(*)	20014N	(*)
FC250	16'-21'	20013N	(*)	20014N	(*)
FC 250 - Brembo Brake	18'	20013N	(*)	20014N	(*)
FC 250 - Magura Brake	18'	20013N	(*)	20018N	(*)
FC350	14'-15'	20012N	(*)	20018N	(*)
FC350	16'-21'	20013N	(*)	20018N	(*)
FC 350 - Brembo Brake	18'	20013N	(*)	20018N	(*)
FC 350 - Magura Brake	18'	20013N	(*)	20018N	(*)
FC450	14'-15'	20012N	(*)	20014N	(*)
FC450	16'-21'	20013N	(*)	20014N	(*)
FC 450 - Brembo Brake	18'	20013N	(*)	20014N	(*)
FC 450 - Magura Brake	18'	20013N	(*)	20046N	(*)
FE250	14'-16'	20012N	(*)	20014N	(*)
FE250	17'-21'	20013N	(*)	20014N	(*)
FE501	14'-16'	20012N	(*)	20014N	(*)
FE501	17'-21'	20013N	(*)	20014N	(*)
FE501S	14'-16'	20012N	(*)	20014N	(*)
FE 501S	17'-21'	20013N	(*)	20014N	(*)
TE125	14'-16'	20013N	(*)	20014N	(*)
TE250	14'-16'	20012N	(*)	20014N	(*)
TE250	17'	20013N	(*)	20014N	(*)
TE300	14'-16'	20012N	(*)	20014N	(*)
TE300	17'	20013N	(*)	20014N	(*)
TC65	17' - 21'	20044N	(*)	20045N	(*)
TC85	14' - 20'	20044N	(*)	20045N	(*)
TC125	14'-21'	20013N	(*)	20014N	(*)
TC125 - Brembo Brake	18'	20013N	(*)	20014N	(*)
TC125 - Magura Brake	18'	20013N	(*)	20046N	(*)
TC250	14'-21'	20013N	(*)	20014N	(*)
TC250 - Brembo Brake	18'	20013N	(*)	20014N	(*)
TC250 - Magura Brake	18'	20013N	(*)	20046N	(*)
KAWASAKI					
KX65	00'-21'	20008N	(*)	20020N	(*)
KX85	01'-21'	20008N	(*)	20020N	(*)
KX100	01'-21'	20008N	(*)	20020N	(*)
KX125	00'-05'	20008N	(*)	20020N	(*)
KX125	06'-08'	20009N	(*)	20020N	(*)
KX250	00'-04'	20008N	(*)	20020N	(*)
KX250	05'-08'	20009N	(*)	20020N	(*)
KX250	19'-20'	20009N	(*)	20018N	(*)
KX250F	04'	20008N	(*)	20020N	(*)



N Black

(*) Check price with your distributor.

IMPORTANT: Indicate code color after part#. Example 0973A.

OFF-ROAD LEVERS

HI-TECH PARTS



2022		For the new 2022 motorcycle models check www.puig.tv				
MODEL	YEAR	CLUTCH LEVER + ADAPTOR	N	BRAKE LEVER + ADAPTOR	N	
KX250F	05'-12'	20009N	(*)	20020N	(*)	
KX250F	13'-18'	20009N	(*)	20021N	(*)	
KX450F	06'-12'	20009N	(*)	20020N	(*)	
KX450F	13'-18'	20009N	(*)	20021N	(*)	
KX450	19'-21'	20210N	(*)	20211N	(*)	
KLX450R	08'-15'	20006N	(*)	20020N	(*)	
KTM						
65SX	04'-11'	20007N	(*)	20024N	(*)	
65SX	14'-21'	20044N	(*)	20045N	(*)	
85SX	03'-12'	20007N	(*)	20024N	(*)	
85SX	14'-20'	20044N	(*)	20045N	(*)	
85SX	21'			20045N	(*)	
125EXC	05'-08'	20007N	(*)	20023N	(*)	
125EXC	09'-13'	20013N	(*)	20023N	(*)	
125EXC	14'-16'	20013N	(*)	20014N	(*)	
125SX	05'-08'	20007N	(*)	20023N	(*)	
125SX	09'-13'	20013N	(*)	20023N	(*)	
125SX	14'-15'	20013N	(*)	20014N	(*)	
125SX	16'-21'	20012N	(*)	20014N	(*)	
125XC-W	17'-19'	20012N	(*)	20018N	(*)	
144SX	07'-08'	20007N	(*)	20023N	(*)	
150SX	09'-13'	20013N	(*)	20023N	(*)	
150SX	14'-15'	20013N	(*)	20014N	(*)	
150SX	16'-21'	20012N	(*)	20014N	(*)	
150XC	10'-13'	20013N	(*)	20023N	(*)	
150XC	14'	20013N	(*)	20014N	(*)	
150XC-W	17'-19'	20012N	(*)	20018N	(*)	
200XC	06'-08'	20007N	(*)	20023N	(*)	
200XC	09'	20013N	(*)	20023N	(*)	
200XC-W	06'-08'	20007N	(*)	20023N	(*)	
200XC-W	09'-13'	20013N	(*)	20014N	(*)	
200XC-W	14'-16'	20013N	(*)	20014N	(*)	
200EXC	05'-08'	20007N	(*)	20023N	(*)	
200EXC	09'-13'	20013N	(*)	20023N	(*)	
200EXC	14'-16'	20013N	(*)	20014N	(*)	
250EXC	05'	20007N	(*)	20023N	(*)	
250EXC	06'-13'	20012N	(*)	20023N	(*)	
250EXC	14'-21'	20012N	(*)	20018N	(*)	
250EXC-F	06'-13'	20012N	(*)	20023N	(*)	

2022		For the new 2022 motorcycle models check www.puig.tv			
MODEL	YEAR	CLUTCH LEVER + ADAPTOR	N	BRAKE LEVER + ADAPTOR	N
250EXC-F	14'-21'	20012N	(*)	20014N	(*)
250SX-F	05'-06'	20007N	(*)	20023N	(*)
250SX-F	07'-13'	20012N	(*)	20023N	(*)
250SX-F	14'-21'	20012N	(*)	20014N	(*)
250SX	05'	20007N	(*)	20023N	(*)
250SX	06'-13'	20012N	(*)	20023N	(*)
250SX	14'-21'	20012N	(*)	20014N	(*)
250XC	06'-13'	20012N	(*)	20023N	(*)
250XC	14'-19'	20012N	(*)	20014N	(*)
250XC-F	07'-13'	20012N	(*)	20023N	(*)
250XC-F	14'-19'	20012N	(*)	20014N	(*)
250XCF-W	07'-13'	20012N	(*)	20023N	(*)
250XCF-W	14'-21'	20012N	(*)	20014N	(*)
250XC-W	06'-13'	20012N	(*)	20023N	(*)
250XC-W	14'-21'	20012N	(*)	20014N	(*)
250EXC RACING	05'-06'	20007N	(*)	20023N	(*)
250EXC	14'-21'	20012N	(*)	20014N	(*)
250EXC-F	14'-21'	20012N	(*)	20014N	(*)
300XC-W	06'-13'	20012N	(*)	20023N	(*)
300XC-W	14'-21'	20012N	(*)	20014N	(*)
300EXC	05'	20007N	(*)	20023N	(*)
300EXC	06'-13'	20012N	(*)	20023N	(*)
300EXC	14'-21'	20012N	(*)	20014N	(*)
300XC	06'-13'	20012N	(*)	20023N	(*)
300XC	14'-19'	20012N	(*)	20014N	(*)
300MXC	05'	20007N	(*)	20023N	(*)
FREERIDE 250R	14'-17'	20044N	(*)	20045N	(*)
FREERIDE 350	14'-17'	20044N	(*)	20045N	(*)
350SX-F	11'-13'	20012N	(*)	20023N	(*)
350SX-F	14'-21'	20012N	(*)	20014N	(*)
350XC-F	11'-13'	20012N	(*)	20023N	(*)
350XC-F	14'-19'	20012N	(*)	20014N	(*)
350XCF-W	12'-13'	20012N	(*)	20023N	(*)
350EXC-F	06'-13'	20012N	(*)	20023N	(*)
350EXC-F	14'-21'	20012N	(*)	20014N	(*)
400EXC	09'-11'	20012N	(*)	20023N	(*)
400XC-W	07'	20007N	(*)	20023N	(*)
400XC-W	09'-10'	20012N	(*)	20023N	(*)
400EXC RACING	05'-07'	20007N	(*)	20023N	(*)
450EXC RACING	05'-07'	20007N	(*)	20023N	(*)
450EXC	07'-13'	20012N	(*)	20023N	(*)
450EXC	14'-16'	20012N	(*)	20014N	(*)

N Black

(*) Check price with your distributor.
IMPORTANT: Indicate code color after part#. Example 0973A.

OFF-ROAD LEVERS

HI-TECH PARTS



2022		For the new 2022 motorcycle models check www.puig.tv			
MODEL	YEAR	CLUTCH LEVER + ADAPTOR	N	BRAKE LEVER + ADAPTOR	N
450XC-F	17'-21'	20012N	(*)	20014N	(*)
450XC-R	08'	20012N	(*)	20014N	(*)
450SX	06'	20013N	(*)	20023N	(*)
450SX-F	07'-08'	20007N	(*)	20023N	(*)
450SX-F	09'-12'	20013N	(*)	20023N	(*)
450SX-F	13'	20012N	(*)	20023N	(*)
450SX-F	14'-21'	20012N	(*)	20014N	(*)
450XC	07'	20007N	(*)	20023N	(*)
450XC-F	08'	20012N	(*)	20023N	(*)
450XC-F	09'	20007N	(*)	20023N	(*)
450XC-F	13'	20012N	(*)	20023N	(*)
450XC-F	14'-19'	20012N	(*)	20014N	(*)
450XC-W	07'	20007N	(*)	20023N	(*)
450XC-W	09'-13'	20012N	(*)	20023N	(*)
450XC-W	14'-16'	20012N	(*)	20014N	(*)
450XCR-W (SIX DAYS)	08'	20012N	(*)	20023N	(*)
500XC-W	12'-13'	20012N	(*)	20023N	(*)
500XC-W	14'-16'	20012N	(*)	20014N	(*)
500EXC	12'-13'	20012N	(*)	20023N	(*)
500EXC	14'-16'	20012N	(*)	20014N	(*)
500EXC-F	17'-21'	20012N	(*)	20014N	(*)
505XC-F	08'	20007N	(*)	20023N	(*)
505XC-F	09'	20007N	(*)	20023N	(*)
525SX	06'	20013N	(*)	20023N	(*)
525EXC	07'	20012N	(*)	20014N	(*)
525EXC RACING	05'-07'	20007N	(*)	20023N	(*)
525XC	07'	20007N	(*)	20023N	(*)
525XC-W	07'	20007N	(*)	20023N	(*)
530EXC-R	08'	20012N	(*)	20023N	(*)
530EXC	09'-11'	20012N	(*)	20023N	(*)
530XC-W	09'-10'	20012N	(*)	20023N	(*)
530XCR-W	08'	20012N	(*)	20023N	(*)
SUZUKI					
DRZ40 S	00'-19'	20004N	(*)	20016N	(*)
DRZ400SM	00'-19'	20004N	(*)	20016N	(*)
RM85	05'-19'	20005N	(*)	20020N	(*)
RM125	96'-03'	20005N	(*)	20018N	(*)
RM125	04'-08'	20005N	(*)	20020N	(*)
RM250	96'-03'	20005N	(*)	20018N	(*)

2022		For the new 2022 motorcycle models check www.puig.tv			
MODEL	YEAR	CLUTCH LEVER + ADAPTOR	N	BRAKE LEVER + ADAPTOR	N
RM250	04'-08'	20005N	(*)	20020N	(*)
RMZ250	04'	20008N	(*)	20020N	(*)
RMZ250	05'-06'	20009N	(*)	20020N	(*)
RMZ250	07'-20'	20008N	(*)	20020N	(*)
RMZ450	05'-20'	20008N	(*)	20020N	(*)
YAMAHA					
WR250F	05'-16'	20006N	(*)	20020N	(*)
WR250F	17'-20'	20006N	(*)	20021N	(*)
WR450F	05'-15'	20006N	(*)	20020N	(*)
WR450F	16'-21'	20006N	(*)	20021N	(*)
WR250R	07'-17'	20005N	(*)	20017N	(*)
WR250X	07'-17'	20005N	(*)	20017N	(*)
YZ65	18' - 21'	20010N	(*)	20018N	(*)
YZ80	01'-14'	20005N	(*)	20020N	(*)
YZ80	15'-21'	20010N	(*)	20020N	(*)
YZ85	01'-14'	20005N	(*)	20020N	(*)
YZ85	15'-21'	20010N	(*)	20020N	(*)
YZ125	01'-07'	20009N	(*)	20020N	(*)
YZ125	08'-14'	20009N	(*)	20021N	(*)
YZ125	15'-21'	20010N	(*)	20021N	(*)
YZ125X	17'-21'	20010N	(*)	20021N	(*)
YZ250	01'-07'	20009N	(*)	20020N	(*)
YZ250	08'-14'	20009N	(*)	20021N	(*)
YZ250	15'-21'	20010N	(*)	20021N	(*)
YZ250FX	01'-06'	20009N	(*)	20020N	(*)
YZ250FX	07'-08'	20009N	(*)	20021N	(*)
YZ250FX	09'-19'	20010N	(*)	20021N	(*)
YZ250FX	15'-19'	20010N	(*)	20021N	(*)
YZ250X	16'-21'	20010N	(*)	20021N	(*)
YZ426F	01'-07'	20009N	(*)	20020N	(*)
YZ426F	08'	20009N	(*)	20021N	(*)
YZ426F	09'-21'	20010N	(*)	20021N	(*)
YZ450F	01'-07'	20009N	(*)	20020N	(*)
YZ450F	08'	20009N	(*)	20021N	(*)
YZ450F	09'-21'	20010N	(*)	20021N	(*)
YZ450FX	16'-18'	20010N	(*)	20021N	(*)
YZ450FX	19'- 21'	20010N	(*)	20018N	(*)



(*) Check price with your distributor.
IMPORTANT: Indicate code color after part#. Example 0973A.



BRAKE-CLUTCH LIQUID TANK COVER

HI-TECH PARTS | TECHNICAL SECTION



LOOKS

Improves the looks of the bike adding a touch of exclusivity.

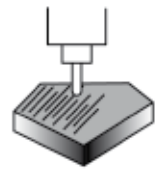

CNC MACHINED

Machined from billet aluminium and anodized in different colors.



REF. 9264V



R Red



V Green



A Blue



P Silver



T Orange



O Gold



N Black

FOR SPECIFIC MODELS SEE PAGE 252.

GLOVE FOR FRONT BRAKE TANK

HI-TECH PARTS | TECHNICAL SECTION

MODEL	REF.	N
GLOVE FOR FRONT BRAKE TANK	5208N	(*)

REF. 5208N



N Black

(*) Check price with your distributor.
IMPORTANT: Indicate code color after part#. Example 0973A.

BRAKE-CLUTCH LIQUID TANK COVER

HI-TECH PARTS

2022		For the new 2022 motorcycle models check www.puig.tv			
MODEL	YEAR	BRAKE LIQUID TANK COVER		CLUTCH LIQUID TANK COVER	
BMW					
F650 GS	08' - 12'	9272	(*)		
F700 GS	12' - 17'	9272	(*)		
F750 GS	18' - 21'	9530	(*)		
F800 GT	13' - 20'	9272	(*)		
F800 GS	08' - 17'	9272	(*)		
F800R	09' - 20'	9272	(*)		
F850 GS	18' - 21'	9530	(*)		
F850 GS ADVENTURE	19' - 21'	9530	(*)		
F900XR	20' - 21'	9530	(*)		
G310R	16' - 21'	9612	(*)		
G310 GS	17' - 21'	9612	(*)		
R1200 R	15' - 18'	9273	(*)	9282	(*)
R1200 RS	15' - 18'	9273	(*)	9282	(*)
R1200 GS	13' - 18'	9273	(*)	9282	(*)
R1200GS EXCLUSIVE	17' - 18'	9273	(*)	9282	(*)
R1200GS RALLYE	17' - 18'	9273	(*)	9282	(*)
R1250GS	18' - 21'	9273	(*)	9282	(*)
R1250GS HP	18' - 21'	9273	(*)	9282	(*)
R1250GS ADVENTURE	18' - 20'	9273	(*)	9282	(*)
R1250GS RALLYE	18' - 21'	9273	(*)	9282	(*)
R1250R	19' - 21'	9273	(*)	9282	(*)
R1250RS	19' - 21'	9273	(*)	9282	(*)
R NINE T	14'	9273	(*)	9282	(*)
R NINE T (#)	15' - 16'	9273	(*)	9282	(*)
R NINE T (&)	15' - 16'	9530	(*)	9531	(*)
R NINE T	17' - 21'	9530	(*)	9531	(*)
R NINE T URBAN G/S	17' - 21'	9530	(*)	9531	(*)
R NINE T PURE	17' - 21'	9530	(*)	9531	(*)
R NINE T RACER	17' - 20'	9530	(*)	9531	(*)
S1000 R	14' - 20'	9264	(*)		
S1000 R	21'	9530	(*)		
S1000RR	19' - 20'	9264	(*)		
S1000RR	15' - 18'	9264	(*)		
S1000RR	19' - 21'	9264	(*)		
S1000 XR	20' - 21'	9530	(*)		
DUCATI					
HYPERMOTARD 821/SP	13' - 15'	9499	(*)		
HYPERMOTARD 939/SP	16' - 19'	9499	(*)		
HYPERSTRADA	13' - 15'	9499	(*)		

2022		For the new 2022 motorcycle models check www.puig.tv			
MODEL	YEAR	BRAKE LIQUID TANK COVER		CLUTCH LIQUID TANK COVER	
MONSTER 696	08' - 14'	9499	(*)		
MONSTER 796	10' - 14'	9499	(*)		
MONSTER 797	17' - 20'	9499	(*)		
MONSTER 821	14' - 20'	9499	(*)		
MULTISTRADA 950	17' - 21'	9499	(*)		
SCRAMBLER ICON/CLASSIC/FULL THROTTLE	15' - 21'	9499	(*)		
SCRAMBLER SIXTY2	16' - 21'	9499	(*)		
SCRAMBLER URBAN ENDURO	15' - 16'	9499	(*)		
SCRAMBLER FLAT TRACK PRO	16'	9499	(*)		
SCRAMBLER 1100	18' - 21'	9499	(*)	9540	(*)
SCRAMBLER 1100 SPORT	18' - 21'	9499	(*)	9540	(*)
SCRAMBLER 1100 SPECIAL	18' - 21'	9499	(*)	9540	(*)
HONDA					
CB125R NEO SPORTS CAFE	18' - 20'	9274	(*)		
CB300R NEO SPORTS CAFE	18' - 21'	9274	(*)		
CB500F	13' - 21'	9274	(*)		
CB500X	13' - 21'	9274	(*)		
CB600F HORNET	98' - 06'	9262	(*)		
CB600F HORNET	07' - 15'	9262	(*)		
CB650F	14' - 20'	9262	(*)		
CB650R NEO SPORTS CAFÉ	19' - 21'	9262	(*)		
CB900F HORNET	02' - 05'	9262	(*)		
CB1000R	08' - 16'	9264	(*)	9262	(*)
CB1000R NEO SPORTS CAFE	18' - 21'	9758	(*)		
CB1000R BLACK EDITION	21'	9758	(*)		
CB1100	13' - 14'	9262	(*)	9262	(*)
CB1100EX	14' - 21'	9262	(*)	9262	(*)
CB1100RS	17' - 21'	9262	(*)	9262	(*)
CB1300	02' - 10'	9262	(*)	9262	(*)
CBF600/S	04' - 07'	9262	(*)		
CBF600/S	08' - 14'	9262	(*)		
CBR250R	11' - 14'	9274	(*)		
CBR500R	13' - 21'	9274	(*)		
CBR600F	86' - 07'	9262	(*)		
CBR600F	11' - 13'	9262	(*)		
CBR600RR	07' - 09'	9264	(*)		
CBR650F	14' - 20'	9262	(*)		
CBR650R	19' - 21'	9262	(*)		
CBR900RR FIRE BLADE	98' - 99'	9262	(*)		

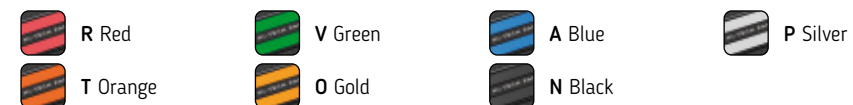



(#) BMW R NINE T with production code 0A6, 0A16
 (&) BMW R NINE T with production code 0J01, 0J03



(*) Check price with your distributor.

IMPORTANT: Indicate code color after part#. Example 0973A.

BRAKE-CLUTCH LIQUID TANK COVER

HI-TECH PARTS

2022						For the new 2022 motorcycle models check www.puig.tv					
MODEL	YEAR	BRAKE LIQUID TANK COVER		CLUTCH LIQUID TANK COVER							
CBR1000RR FIRE BLADE	04' - 07'	9264	(*)								
CBR1000RR FIRE BLADE	08' - 11'	9264	(*)								
CBR1000RR FIRE BLADE	12' - 16'	9264	(*)								
CBR1000RR FIREBLADE/SP/SP2	17' - 19'	9264	(*)								
CBR1000RR FIREBLADE/SP	20' - 21'	9264	(*)								
CMX 1100 REBEL	21'	9262	(*)								
CROSSRUNNER	11' - 21'	9262	(*)	9262	(*)						
CROSSTOURER	12' - 21'	9262	(*)	9262	(*)						
FORZA 750	21'	9262	(*)	9262	(*)						
INTEGRA 700	12' - 13'	9262	(*)	9262	(*)						
INTEGRA 750	14' - 21'	9262	(*)	9262	(*)						
INTEGRA 750S	14' - 16'	9262	(*)	9262	(*)						
MSX125	14' - 20'	9274	(*)								
NC700S/X	12' - 13'	9262	(*)								
NC750S/X	14' - 21'	9262	(*)								
NT700V DEAUVILLE	06' - 12'	9262	(*)								
VFR800	02' - 05'	9262	(*)	9262	(*)						
VFR800F	14' - 20'	9262	(*)	9262	(*)						
X-ADV	17' - 21'	9262	(*)	9262	(*)						
KAWASAKI											
ER-6F	09' - 16'	9275	(*)								
ER-6N	09' - 16'	9275	(*)								
NINJA 125	19' - 21'	9274	(*)								
NINJA 400	18' - 21'	3547	(*)								
NINJA 650	20' - 21'	9275	(*)								
NINJA H2 SX	18' - 21'	9264	(*)	20533	(*)						
NINJA 1000 SX	20' - 21'	9264	(*)								
VERSYS 650	09' - 21'	9275	(*)								
VERSYS 1000	15' - 20'	9264	(*)								
VULCAN S	15' - 21'	9275	(*)								
VULCAN S CAFE	17' - 20'	9275	(*)								
Z125	19' - 21'	9274	(*)								
Z400	19' - 21'	3547	(*)								
Z650	17' - 21'	9275	(*)								
Z800	13' - 16'	9275	(*)								
Z800E	13' - 16'	9275	(*)								
Z900	17' - 21'	9275	(*)								
Z900RS	18' - 21'	9264	(*)								
Z900RS CAFÉ	18' - 21'	9264	(*)								
Z1000	07' - 09'	9264	(*)								

2022			For the new 2022 motorcycle models check www.puig.tv								
MODEL	YEAR	BRAKE LIQUID TANK COVER		CLUTCH LIQUID TANK COVER							
Z1000	10' - 21'	9277	(*)								
Z1000R	17' - 21'	9277	(*)								
Z1000SX	10' - 19'	9264	(*)								
ZH2	20' - 21'	9264	(*)	20533	(*)						
Z H2 SE	20' - 21'	9264	(*)	20533	(*)						
ZX-6R	00' - 04'	9264	(*)								
ZX-6R	05' - 06'	9264	(*)								
ZX-6R	07' - 16'	9264	(*)								
ZX-6R 636	13' - 16'	9264	(*)								
ZX-6R 636	19' - 21'	9264	(*)								
ZX-9R	98' - 99'	9264	(*)								
ZX-9R	00' - 04'	9264	(*)								
ZX-10R	04' - 05'	9264	(*)								
ZX-10R	06' - 10'	9264	(*)								
ZX-10R	11' - 15'	9264	(*)								
KTM											
125 DUKE	17' - 21'	9612	(*)								
390 DUKE	17' - 21'	9612	(*)								
KYMCO											
AK 550	17' - 21'	9499	(*)	9540	(*)						
MV AGUSTA											
SUPERVELOCE	21'	9264	(*)								
SUZUKI											
BURGMAN 400	17' - 21'	9274	(*)	9274	(*)						
DL250 V-STROM	17' - 21'	9270	(*)								
DL650 V-STROM	04' - 10'	9270	(*)								
DL650 V-STROM	11'	9270	(*)								
DL650 V-STROM	12' - 21'	9270	(*)								
DL650XT V-STROM	15' - 21'	9270	(*)								
DL1000 V-STROM	17' - 19'	9270	(*)								
DL1000XT V-STROM	17' - 19'	9270	(*)								
DL1050 V-STROM	20' - 21'	9270	(*)	9270	(*)						
DL1050XT V-STROM	20' - 21'	9270	(*)	9270	(*)						
GSR750	11' - 16'	9270	(*)								
GSX-S125	17' - 21'	9612	(*)								
GSX-R125	17' - 21'	9612	(*)								
GSX-R250	17' - 21'	9270	(*)								
GSX-R600	96' - 03	9270	(*)								
GSX-R600	04' - 16	9264	(*)								

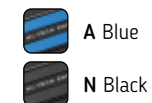
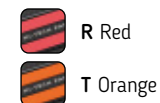





(#) BMW R NINE T with production code 0A6, 0A16
 (&) BMW R NINE T with production code 0J01, 0J03
 (*) Check price with your distributor.

IMPORTANT: Indicate code color after part#. Example 0973A.

BRAKE-CLUTCH LIQUID TANK COVER

HI-TECH PARTS

2022		For the new 2022 motorcycle models check www.puig.tv				
MODEL	YEAR	BRAKE LIQUID TANK COVER		CLUTCH LIQUID TANK COVER		
GSX-R750	96' - 03'	9270	(*)			
GSX-R750	04' - 16'	9264	(*)			
GSX-R1000	01' - 04'	9270	(*)			
GSX-R1000	05' - 16'	9264	(*)			
GSX-R1000/R	17' - 20'	9264	(*)			
GSX-S750	17' - 21'	9270	(*)			
GSX-S1000	22'	3648	(*)			
INAZUMA	13' - 17'	9270	(*)			
KATANA	19' - 21'	3648	(*)			
SFV650 GLADIUS	09' - 15'	9270	(*)			
SV650	99' - 04'	9270	(*)			
SV650	05'	9270	(*)			
SV650	06' - 08'	9270	(*)			
SV650S	99' - 04'	9270	(*)			
SV650S	05'	9270	(*)			
SV650S	06' - 08'	9270	(*)			
SV650	16' - 21'	9270	(*)			
SV650X	18' - 21'	9264	(*)			
SYM						
MAXSYM TL	20' - 21'	9262	(*)	9262	(*)	
TRIUMPH						
DAYTONA 675	06' - 12'	9264	(*)			
DAYTONA 675	13' - 17'	9264	(*)			
SPEED TRIPLE	08' - 10'	9264	(*)			
STREET TRIPLE R	09' - 16'	9264	(*)			
YAMAHA						
FZ1	06' - 15'	9267	(*)			
FZ1 FAZER	06' - 15'	9267	(*)			
FZ6	04' - 06'	9267	(*)			
FZ6 FAZER	07' - 08'	9267	(*)			
FZ8	10' - 16'	9267	(*)			
MT-07	14' - 21'	9267	(*)			
MT-07 TRACER	16' - 21'	9267	(*)			
MT-07 TRACER GT	19' - 21'	9267	(*)			
MT-09	13' - 16'	9267	(*)			
MT-09	17' - 20'	9267	(*)			
MT-09	21'	9264	(*)			
MT-09 SP	18' - 20'	9267	(*)			
MT-09 SP	21'	9264	(*)			
MT-09 TRACER	15' - 20'	9267	(*)			

2022		For the new 2022 motorcycle models check www.puig.tv				
MODEL	YEAR	BRAKE LIQUID TANK COVER		CLUTCH LIQUID TANK COVER		
MT-09 TRACER/GT	21'	9264	(*)			
MT-09 TRACER GT	18' - 20'	9267	(*)			
MT-10	16' - 21'	9267	(*)			
MT-10 SP	17' - 21'	9267	(*)			
NIKEN	18' - 21'	9267	(*)			
TENERE 700	19' - 21'	9267	(*)			
T-MAX 500	08' - 11'	9269	(*)	9269	(*)	
T-MAX 530	12' - 14'	9269	(*)	9269	(*)	
T-MAX 530	15' - 16'	9269	(*)	9269	(*)	
T-MAX 530/DX/SX	17' - 19'	9269	(*)	9269	(*)	
T-MAX 560 /SX/DX/MAX TECH	20' - 21'	9269	(*)	9269	(*)	
XJ6	09' - 16'	9267	(*)			
XJ6 DIVERSION	09' - 16'	9267	(*)			
XJ6 DIVERSION F	10' - 16'	9267	(*)			
XSR700	16' - 21'	9267	(*)			
XSR700 XTRIBUTE	19' - 21'	9267	(*)			
XSR900	16' - 21'	9267	(*)			
XT660Z TÉNÉRÉ	08' - 16'	9267	(*)			
XT1200Z SUPER TÉNÉRÉ	18' - 21'	9267	(*)			
XT1200ZE SUPER TENERE	19' - 21'	9267	(*)			
YZF-R1	04' - 16'	9264	(*)			
YZF-R1	20' - 21'	9264	(*)			
YZF-R1M	20' - 21'	9264	(*)			
YZF-R6	06' - 20'	9264	(*)			

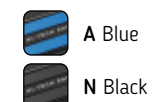
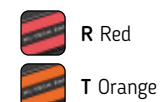

(#) BMW R NINE T with production code 0A6, 0A16
 (&) BMW R NINE T with production code 0J01, 0J03
 (*) Check price with your distributor.
IMPORTANT: Indicate code color after part#. Example 0973A.



PARKING BRAKE LEVER

HI-TECH PARTS | TECHNICAL SECTION



LOOK

Improves the looks of the bike adding a touch of exclusivity.

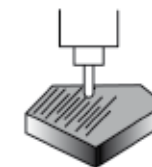

CNC MACHINED

Machined from billet aluminium and anodized in different colors.

REF. 85000



MODEL	YEAR	REF.	A R O N P
KYMCO			
AK550	17' - 21'	9544	(*)
YAMAHA			
T-MAX 530	12' - 16'	8500	(*)
T-MAX 530/DX/SX	17' - 19'	8500	(*)
T-MAX 560 /SX/DX/MAX TECH	20' - 21'	8500	(*)

R Red
A Blue
N Black

P Silver
O Gold

(*) Check price with your distributor.
IMPORTANT: Indicate code color after part#. Example 0973A.

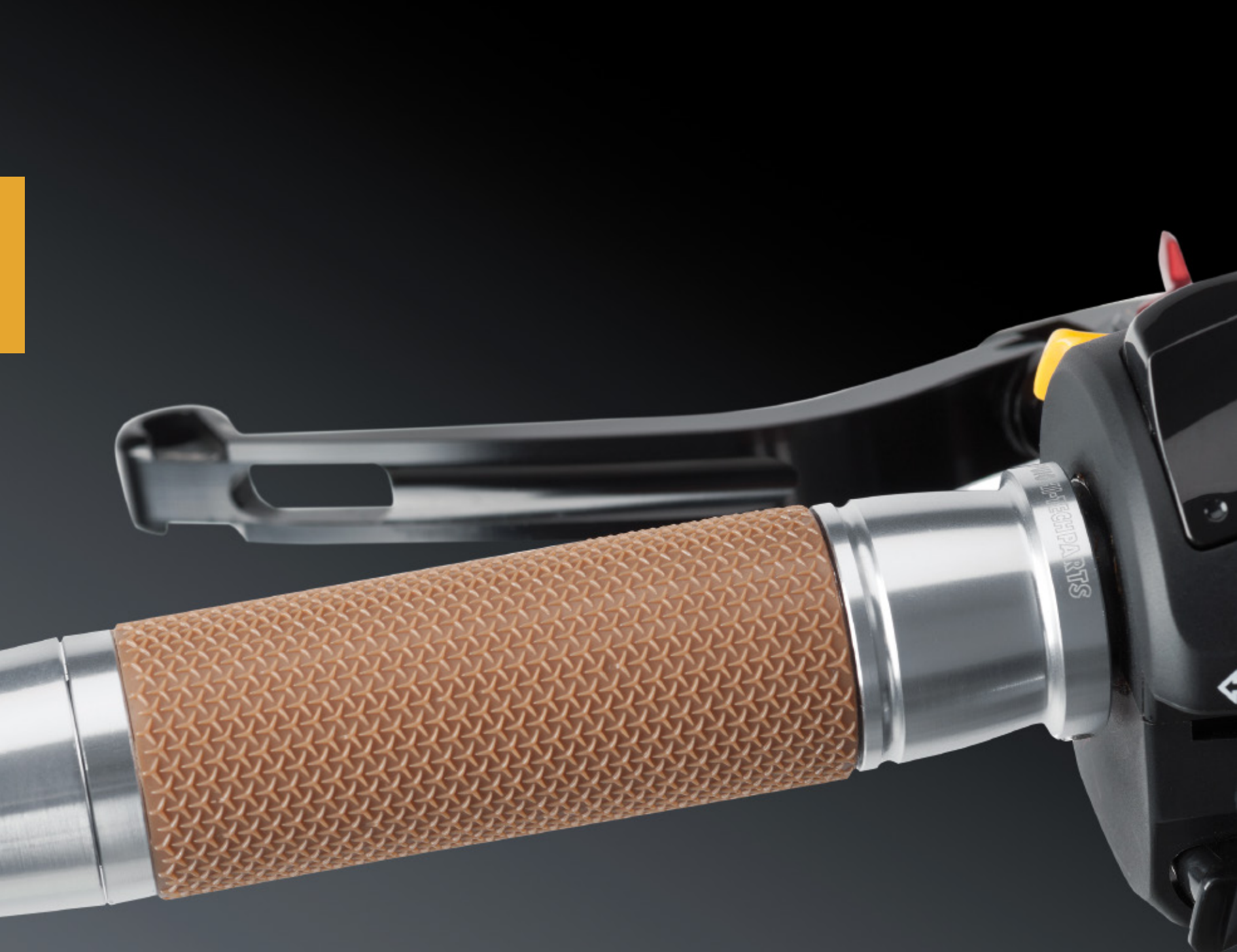

VINTAGE GRIPS

HI-TECH PARTS | TECHNICAL SECTION

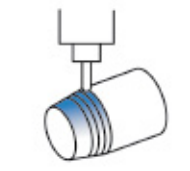

MATERIAL
Manufactured from billet aluminium.

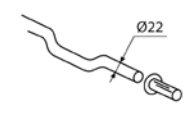

HANDLEBAR
Suitable for diameter 22 mm.



RUBBER
Non-skid texture.
Pleasant compound.





WEIGHT
Reduced to 94 grams.

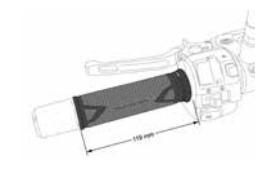

THROTTLE ADAPTORS
Included.



DIMENSIONS
Long 119 mm.

-  N Black
-  P Silver



* Check availability for motorcycle models at www.puig.tv typing in the searching window.



MODEL	DIMENSIONS	REF.	N P
VINTAGE GRIPS BY PAIR	119 mm.	9190	(*)

* NOT SUITABLE WITH THE ELECTRONIC SYSTEM RIDE BY WIRE.
 * NOT SUITABLE WITH OEM HEATED GRIPS.
 * NOT SUITABLE FOR BIKES WHERE THE GRIPS CANNOT BE SEPARATED FROM THE GAS CANE.
 (*) Check price with your distributor.
IMPORTANT: Indicate code color after part#. Example 0973A.



ASCENT GRIPS

HI-TECH PARTS | TECHNICAL SECTION

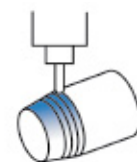

MATERIAL
Manufactured from billet aluminium.

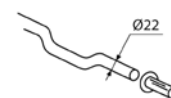

HANDLEBAR
Suitable for diameter 22 mm.



RUBBER
Non-skid texture.
Pleasant compound.



WEIGHT
Reduced to 94 grams.



THROTTLE ADAPTORS
Included.

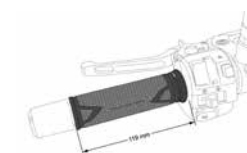

DIMENSIONS
Long 119 mm.

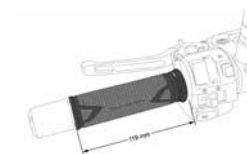

DIMENSIONS
Long 123 mm.



R Red



T Orange



O Gold



N Black



V Green



A Blue



P Silver



* Check availability for motorcycle models at www.puig.tv typing in the searching window.



REF. 6326A

MODEL	DIMENSIONS	REF.	R O A T N P V
ASCENT GRIPS BY PAIR	119 mm.	6326	(*)
ASCENT GRIPS BY PAIR	123 mm.	3553	(*)

* NOT SUITABLE WITH THE ELECTRONIC SYSTEM RIDE BY WIRE.

* NOT SUITABLE WITH OEM HEATED GRIPS.

* NOT SUITABLE FOR BIKES WHERE THE GRIPS CANNOT BE SEPARATED FROM THE GAS CANE.

(*) Check price with your distributor.

IMPORTANT: Indicate code color after part#. Example 0973A.



RADIKAL GRIPS

HI-TECH PARTS | TECHNICAL SECTION



HANDLEBAR
Suitable for diameter 22 mm.



RUBBER
Non-skid texture.
Pleasant compound.



WEIGHT
Reduced to 64 grams.

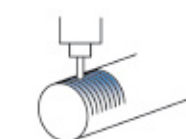

DETAIL
Aluminium anodized insertion in different colors.

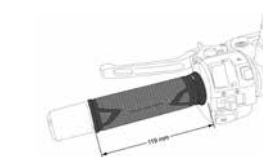

DIMENSIONS
Long 119 mm.

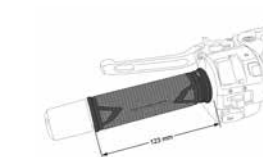

DIMENSIONS
Long 123 mm.

*** IMPORTANT:** Due to the wide variety of original grips, some motorcycles may need to lower the edges of the gas throttle and the use of glue (such as Fischer MS Express) for a correct fixation.

In motorcycle models where it is not possible to separate the rubber grip from the gas cane because they are one piece, it is not possible to install the grips.



R Red



V Green



T Orange



A Blue

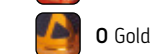

O Gold

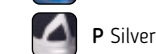

P Silver



N Black



C Carbon look



* Check availability for motorcycle models at www.puig.tv typing in the searching window.



REF. 63250

MODEL	DIMENSIONS	REF.	R O A T N P V C
RADIKAL GRIPS BY PAIR	119 mm.	6325	(*)
RADIKAL GRIPS BY PAIR	123 mm.	8191	(*)

* NOT SUITABLE WITH THE ELECTRONIC SYSTEM RIDE BY WIRE.

* NOT SUITABLE WITH OEM HEATED GRIPS.

* NOT SUITABLE FOR BIKES WHERE THE GRIPS CANNOT BE SEPARATED FROM THE GAS CANE.

(*) Check price with your distributor.

IMPORTANT: Indicate code color after part#. Example 0973A.



RACING GRIPS

HI-TECH PARTS | TECHNICAL SECTION



HANDLEBAR
Suitable for diameter 22 mm.



RUBBER
Non-skid texture.
Pleasant compound.



WEIGHT
Reduced to 68 grams.

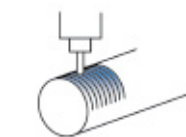

DETAIL
Aluminium anodized
insertion in different
colors.

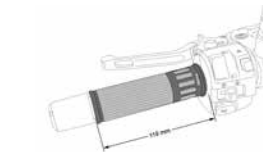

DIMENSIONS
Long 119 mm.

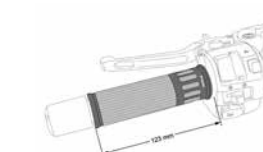

DIMENSIONS
Long 123 mm.

*** IMPORTANT:** Due to the wide variety of original grips, some motorcycles may need to lower the edges of the gas throttle and the use of glue (such as Fischer MS Express) for a correct fixation.

In motorcycle models where it is not possible to separate the rubber grip from the gas cane because they are one piece, it is not possible to install the grips.



R Red



V Green



T Orange



A Blue



O Gold



P Silver



N Black



* Check availability for motorcycle models at www.puig.tv typing in the searching window.



REF. 5879A

MODEL	DIMENSIONS	REF.	R O A T N P V
RACING GRIPS BY PAIR	119 mm.	5879	(*)
RACING GRIPS BY PAIR	123 mm.	8188	(*)

* NOT SUITABLE WITH THE ELECTRONIC SYSTEM RIDE BY WIRE.

* NOT SUITABLE WITH OEM HEATED GRIPS.

* NOT SUITABLE FOR BIKES WHERE THE GRIPS CANNOT BE SEPARATED FROM THE GAS CANE.

(*) Check price with your distributor.

IMPORTANT: Indicate code color after part#. Example 0973A.

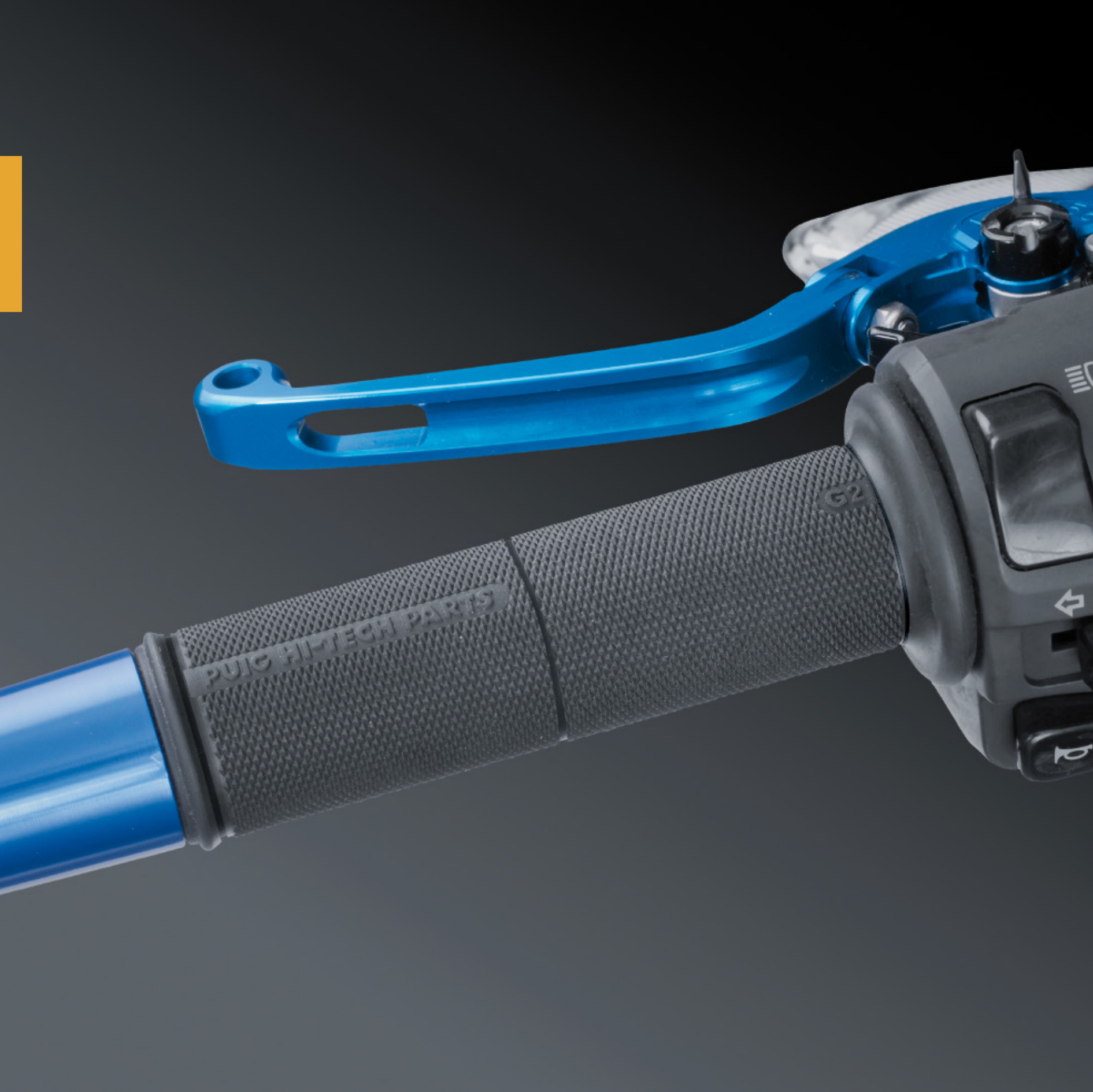

BASIC GRIPS

HI-TECH PARTS | TECHNICAL SECTION



* Check availability for motorcycle models at www.puig.tv typing in the searching window.



HANDLEBAR
Suitable for diameter 22 mm.



RUBBER
Non-skid texture.
Pleasant compound.

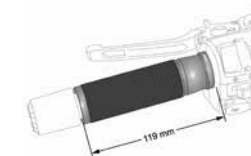

DIMENSIONS
Long 119 mm.

*** IMPORTANT:** Due to the wide variety of original grips, some motorcycles may need to lower the edges of the gas throttle and the use of glue (such as Fischer MS Express) for a correct fixation.

In motorcycle models where it is not possible to separate the rubber grip from the gas cane because they are one piece, it is not possible to install the grips.



MODEL	TOUCH	REF.	N
GRIPS OPENED END BY PAIR	SOFT	6404N	(*)
GRIPS OPENED END BY PAIR	MEDIUM	6405N	(*)
GRIPS OPENED END BY PAIR	HARD	6406N	(*)

* NOT SUITABLE WITH THE ELECTRONIC SYSTEM RIDE BY WIRE.

* NOT SUITABLE WITH OEM HEATED GRIPS.

* NOT SUITABLE FOR BIKES WHERE THE GRIPS CANNOT BE SEPARATED FROM THE GAS CANE.

(*) Check price with your distributor.

IMPORTANT: Indicate code color after part#. Example 0973A.

 N Black



BAR ENDS SPORT

HI-TECH PARTS | TECHNICAL SECTION

NEW!

BAR ENDS

* Check availability for motorcycle models at www.puig.tv typing in the searching window.



DIMENSIONS



68gr.



REF. 20855A

SPORT MODEL	REF.	R O A T N P V
BAR ENDS BY PAIR SPORT MODEL	SEE WEB	
SET OF UNIVERSAL BLACK SECTION FOR HANDLEBARS DIAMETERS BETWEEN 13-18 mm.	20855	(*)
BAR ENDS BY PAIR FOR PUIG HANDLEBAR WITH INTERIOR THREAD	20856	(*)

SPARES	REF.	N
WELLNUT M10 BY PAIR	6815N	(*)
WELLNUT M15 BY PAIR	6816N	(*)
WELLNUT M17 BY PAIR	6817N	(*)

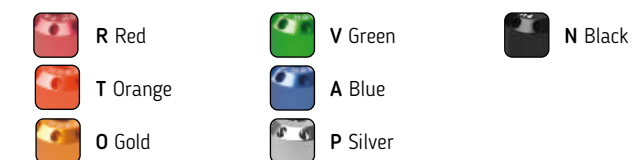

(*) Check price with your distributor.
IMPORTANT: Indicate code color after part#. Example 0973A.



BAR ENDS SPEED

HI-TECH PARTS | TECHNICAL SECTION

NEW!

BAR ENDS

* Check availability for motorcycle models at www.puig.tv typing in the searching window.



SPEED MODEL	REF.	R O A T N P V
BAR ENDS BY PAIR SPEED MODEL	SEE WEB	
SET OF UNIVERSAL SECTION FOR HANDLEBARS DIAMETERS BETWEEN 13-18 mm.	20857	(*)
BAR ENDS BY PAIR FOR PUIG HANDLEBAR WITH INTERIOR THREAD	20858	(*)

SPARES	REF.	N
WELLNUT M10 BY PAIR	6815N	(*)
WELLNUT M15 BY PAIR	6816N	(*)
WELLNUT M17 BY PAIR	6817N	(*)

- R Red
- V Green
- N Black
- T Orange
- A Blue
- O Gold
- P Silver

(*) Check price with your distributor.
IMPORTANT: Indicate code color after part#. Example 0973A.



BAR ENDS LONG AND SHORT

HI-TECH PARTS | TECHNICAL SECTION



* Check availability for motorcycle models at www.puig.tv typing in the searching window.

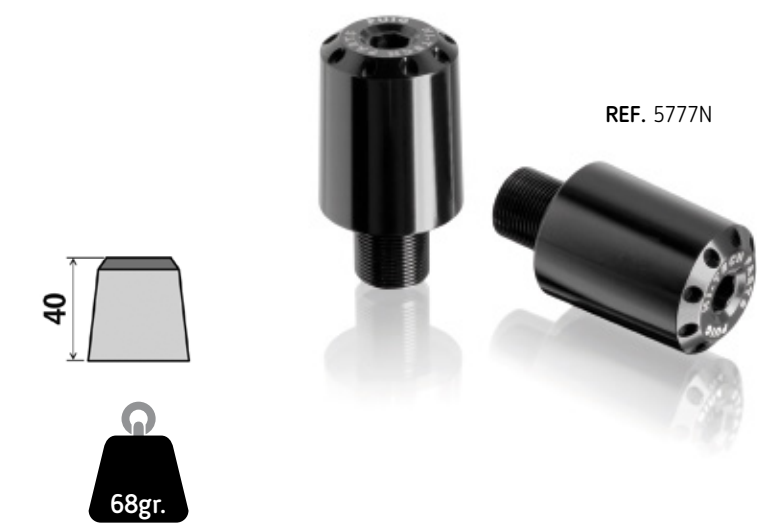

LONG MODEL	REF.	R O A T N P V
BAR ENDS BY PAIR LONG MODEL	SEE WEB	
SET OF UNIVERSAL SECTION FOR HANDLEBARS DIAMETERS BETWEEN 13-18 mm.	5777	(*)



SHORT MODEL	REF.	R O A T N P V
BAR ENDS BY PAIR SHORT MODEL	SEE WEB	
SET OF UNIVERSAL SECTION FOR HANDLEBARS DIAMETERS BETWEEN 13-18 mm.	6203	(*)
BAR ENDS BY PAIR FOR PUIG HANDLEBAR WITH INTERIOR THREAD	7424	(*)

SPARES	REF.	N
WELLNUT M10 BY PAIR	6815N	(*)
WELLNUT M15 BY PAIR	6816N	(*)
WELLNUT M17 BY PAIR	6817N	(*)

- R Red
- V Green
- N Black
- T Orange
- A Blue
- P Silver
- O Gold

(*) Check price with your distributor.
IMPORTANT: Indicate code color after part#. Example 0973A.

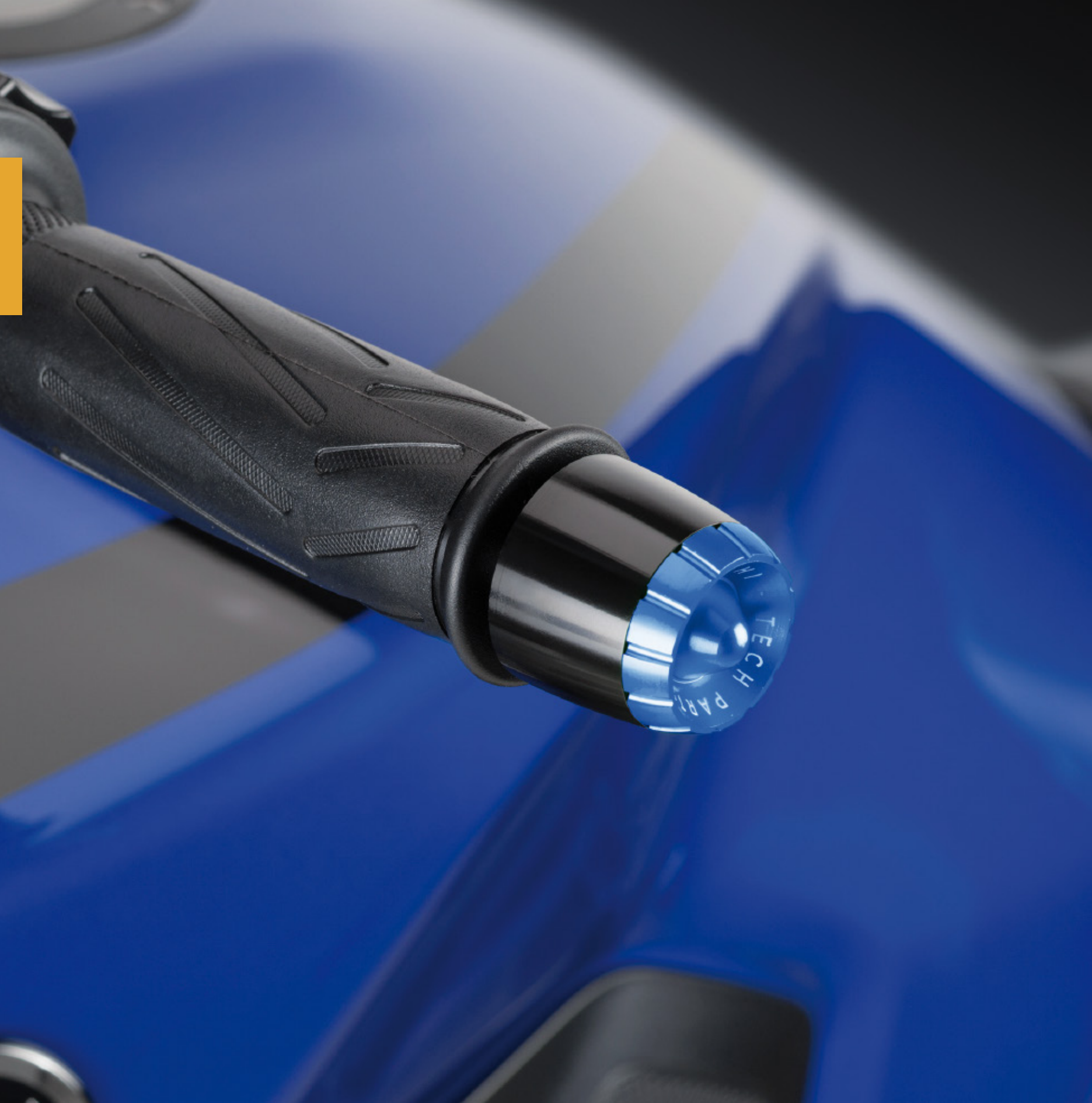

BAR ENDS THRUSTER

HI-TECH PARTS | TECHNICAL SECTION



* Check availability for motorcycle models at www.puig.tv typing in the searching window.

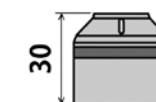

DIMENSIONS



REF. 9420



The black sections and the end caps are sold separately.



REF. 9411N + 9420V



THRUSTER MODEL	REF.	R	O	A	T	N
		N	P	V		
BLACK SECTION BY PAIR THRUSTER MODEL	SEE WEB					
SET OF UNIVERSAL SECTION FOR HANDLEBARS DIAMETERS BETWEEN 13-18 mm.	9411					(*)
CAP'S BAR ENDS THRUSTER	9420	(*)				(*)
BAR ENDS BY PAIR FOR PUIG HANDLEBAR WITH INTERIOR THREAD	9594					(*)

SPARES	REF.	N
WELLNUT M10 BY PAIR	6815N	(*)
WELLNUT M15 BY PAIR	6816N	(*)
WELLNUT M17 BY PAIR	6817N	(*)

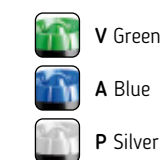
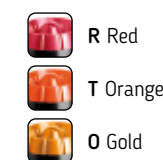

(*) Check price with your distributor.
IMPORTANT: Indicate code color after part#. Example 0973A.



BAR ENDS SHORT WITH RING AND RACE

HI-TECH PARTS | TECHNICAL SECTION



* Check availability for motorcycle models at www.puig.tv typing in the searching window.



The set includes 12 rings (2 each color): blue, orange, black, gold, silver and red.

Green rings only for Kawasaki and Universal models.



SHORT WITH RING MODEL	REF.	N
BAR ENDS BY PAIR SHORT WITH RING MODELS	SEE WEB	
SET OF UNIVERSAL SECTION FOR HANDLEBARS DIAMETERS BETWEEN 13-18 mm.	8498	(*)
BAR ENDS BY PAIR FOR PUIG HANDLEBAR WITH INTERIOR THREAD	8334	(*)
SPARES		REF. R O A T N P V
RINGS BY PAIR	9170	(*)

RACE MODEL	REF.	R O A T N P V
SET OF UNIVERSAL SECTION FOR HANDLEBARS DIAMETERS BETWEEN 13-18 mm.	6222	(*)

SPARES	REF.	N
WELLNUT M10 BY PAIR	6815N	(*)
WELLNUT M15 BY PAIR	6816N	(*)
WELLNUT M17 BY PAIR	6817N	(*)



(*) Check price with your distributor.
IMPORTANT: Indicate code color after part#. Example 0973A.



REARVIEW MIRROR FOLD

HI-TECH PARTS | TECHNICAL SECTION

NEW!

FOLD

* Check availability for motorcycle models at www.puig.tv typing in the searching window.

NOT HOMOLOGATED

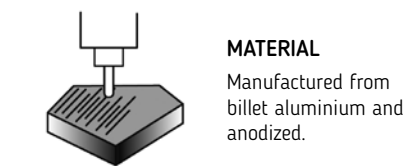
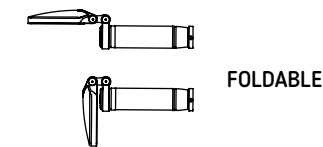
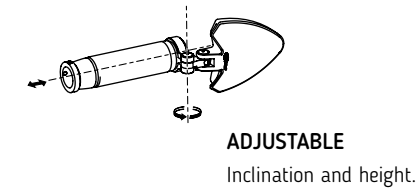
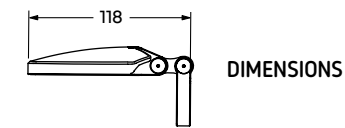
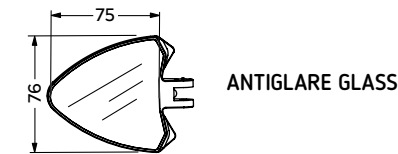

For handlebars with inner diameter of 13/18 mm.

N Black

D Aluminium Anodized

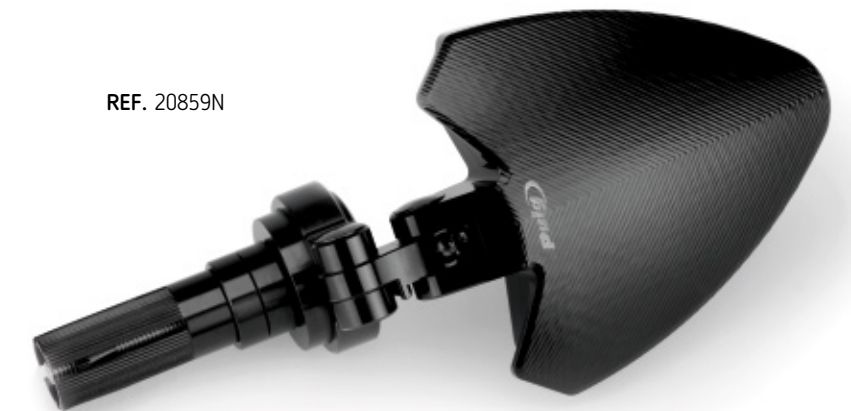

MODEL	SIDE	REF.	N D
UNIVERSAL	RIGHT	20859	(*)
UNIVERSAL	LEFT	21087	(*)

TO SEE PART# FOR THE ADAPTORS ON THE MODELS AVAILABLE: [CHECK WEBSITE.](#)

(*) Check price with your distributor.
IMPORTANT: Indicate code color after part#. Example 0973A.

REARVIEW MIRROR LOOK

HI-TECH PARTS | TECHNICAL SECTION



* Check availability for motorcycle models at www.puig.tv typing in the searching window.



NOT HOMOLOGATED



ANTI GLARE GLASS



DIMENSIONS



ADJUSTABLE
Inclination and height.

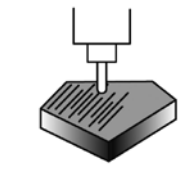

MATERIAL
Manufactured from billet aluminium and anodized.



ADAPTABLE
Specific available adapters for bike model.

For handlebars with inner diameter of 13/18 mm.



REF. 3764D

- N Black
- D Aluminium Anodized

MODEL	SIDE	REF.	N D
UNIVERSAL	RIGHT	3764	(*)
UNIVERSAL	LEFT	3764	(*)

TO SEE PART# FOR THE ADAPTORS ON THE MODELS AVAILABLE: [CHECK WEBSITE.](#)

(*) Check price with your distributor.
IMPORTANT: Indicate code color after part#. Example 0973A.

REARVIEW MIRROR GRAND TRACKER

HI-TECH PARTS | TECHNICAL SECTION



* Check availability for motorcycle models at www.puig.tv typing in the searching window.



HOMOLOGATED

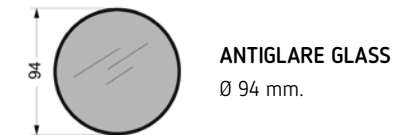

ANTIGLARE GLASS
Ø 94 mm.

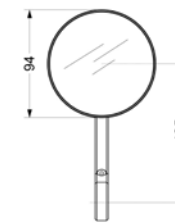

DIMENSIONS



ADJUSTABLE
Inclination and height.



ADAPTABLE
Specific available adapters for bike model.

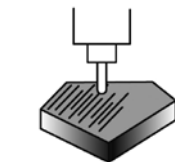

MATERIAL
Manufactured from billet aluminium and anodized.

For handlebars with inner diameter of 13/18 mm.



REF. 9691D

- N Black
- D Aluminium Anodized

MODEL	SIDE	REF.	N D
UNIVERSAL	RIGHT	9691	(*)
UNIVERSAL	LEFT	9691	(*)

TO SEE PART# FOR THE ADAPTORS ON THE MODELS AVAILABLE: [CHECK WEBSITE.](#)

(*) Check price with your distributor.
IMPORTANT: Indicate code color after part#. Example 0973A.



REARVIEW MIRROR TRACKER

HI-TECH PARTS | TECHNICAL SECTION



* Check availability for motorcycle models at www.puig.tv typing in the searching window.

NOT HOMOLOGATED

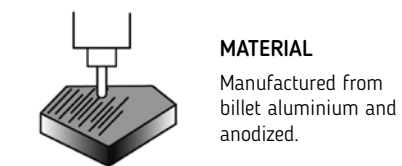
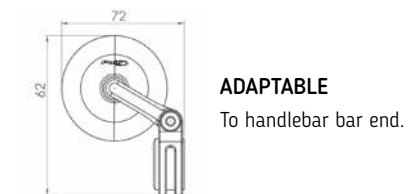
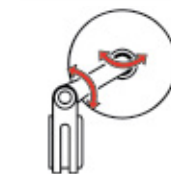
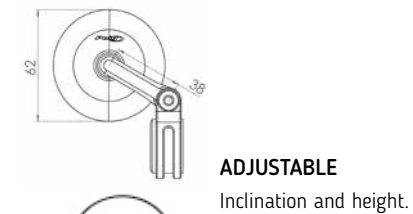

For handlebars with inner diameter of 13/18 mm.

- N Black
- D Aluminium Anodized



MODEL	SIDE	REF.	N D
UNIVERSAL	RIGHT	9506	(*)
UNIVERSAL	LEFT	9506	(*)

TO SEE PART# FOR THE ADAPTORS ON THE MODELS AVAILABLE: **CHECK WEBSITE.**

(*) Check price with your distributor.
IMPORTANT: Indicate code color after part#. Example 0973A.

REARVIEW MIRROR HI-TECH IV

HI-TECH PARTS | TECHNICAL SECTION



* Check availability for motorcycle models at www.puig.tv typing in the searching window.

NOT HOMOLOGATED

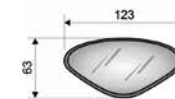

ANTIGLARE GLASS

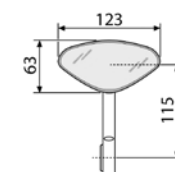

DIMENSIONS



ADJUSTABLE
Inclination and height.



ADAPTABLE
Specific available adapters for bike model.

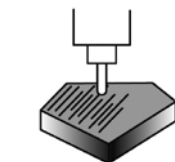

MATERIAL
Manufactured from billet aluminium and anodized.

For handlebars with inner diameter of 13/18 mm.



REF. 6994D

- N Black
- D Aluminium Anodized

MODEL	SIDE	REF.	N D
UNIVERSAL	RIGHT	6994	(*)
UNIVERSAL	LEFT	6994	(*)

TO SEE PART# FOR THE ADAPTORS ON THE MODELS AVAILABLE: [CHECK WEBSITE.](#)

(*) Check price with your distributor.
IMPORTANT: Indicate code color after part#. Example 0973A.



REARVIEW MIRROR MP

HI-TECH PARTS | TECHNICAL SECTION



* Check availability for motorcycle models at www.puig.tv typing in the searching window.

NOT HOMOLOGATED

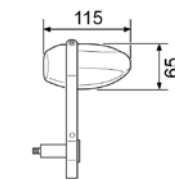
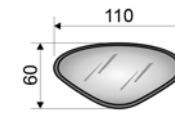

DIMENSIONS



ADAPTABLE

Specific available adapters for bike model.

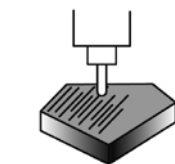

MATERIAL

Manufactured from billet aluminium and anodized.



For handlebars with inner diameter of 13/18 mm.

 N Black

 P Silver



REF. 5220N

MODEL	SIDE	REF.	N	P
UNIVERSAL	RIGHT	5220	(*)	
UNIVERSAL	LEFT	5220	(*)	

TO SEE PART# FOR THE ADAPTORS ON THE MODELS AVAILABLE: [CHECK WEBSITE.](#)

(*) Check price with your distributor.
IMPORTANT: Indicate code color after part#. Example 0973A.

REARVIEW MIRROR MONACO

HI-TECH PARTS | TECHNICAL SECTION



* Check availability for motorcycle models at www.puig.tv typing in the searching window.

NOT HOMOLOGATED

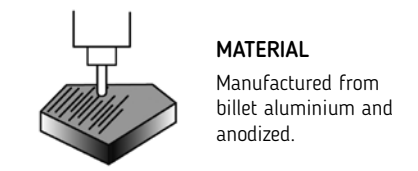
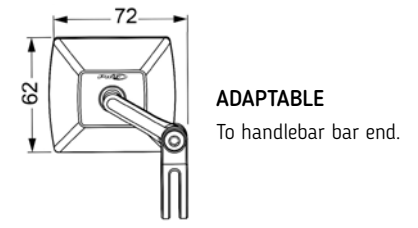
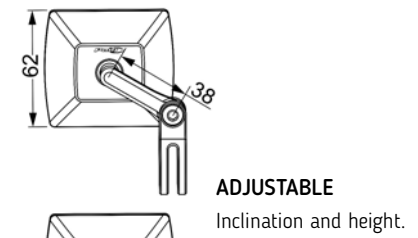

For handlebars with inner diameter of 13/18 mm.

- N Black
- D Aluminium Anodized



MODEL	SIDE	REF.	N D
UNIVERSAL	RIGHT	3668	(*)
UNIVERSAL	LEFT	3668	(*)

TO SEE PART# FOR THE ADAPTORS ON THE MODELS AVAILABLE: **CHECK WEBSITE.**

(*) Check price with your distributor.
IMPORTANT: Indicate code color after part#. Example 0973A.

REARVIEW MIRROR RETRO

HI-TECH PARTS | TECHNICAL SECTION



* Check availability for motorcycle models at www.puig.tv typing in the searching window.

HOMOLOGATED

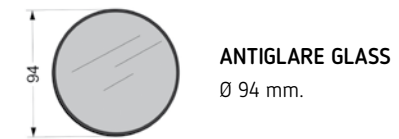

ANTIGLARE GLASS
Ø 94 mm.

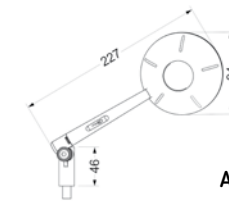

ADJUSTABLE
Inclination and height.

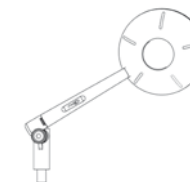
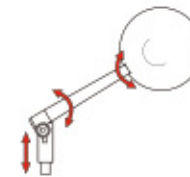

ADAPTABLE
To the handlebar and adapters available for the original fairing.

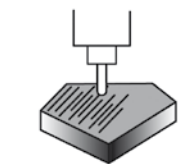

MATERIAL
Manufactured from billet aluminium and anodized.

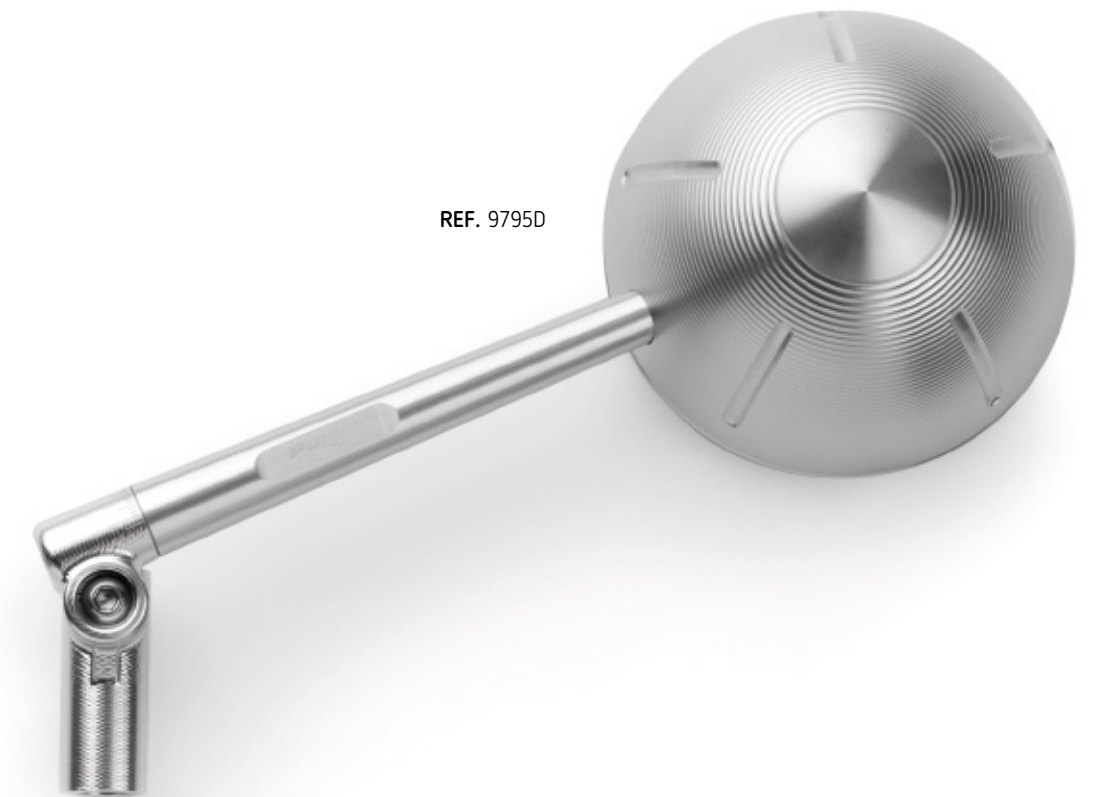

REF. 9795D

MODEL	SIDE	REF.	N D
UNIVERSAL THREAD M10/125	RIGHT	9794 (#)	(*)
UNIVERSAL THREAD M10/125	LEFT	9795 (+)	(*)

(#) SCREW M10/125+M10/125 REVERSE THREAD + SCREW M8/125 + M8/125 REVERSE THREAD.
(+) SCREW M10/125 + SCREW M8/125.

TO SEE PART# FOR THE ADAPTORS ON THE MODELS AVAILABLE: [CHECK OUR WEBSITE](#).
FOR THOSE MODELS REQUIRING ADAPTORS TO ATTACH TO THE FAIRING: [CHECK OUR WEBSITE](#).

(*) Check price with your distributor.

IMPORTANT: Indicate code color after part#. Example 0973A.

N Black

D Aluminium Anodized

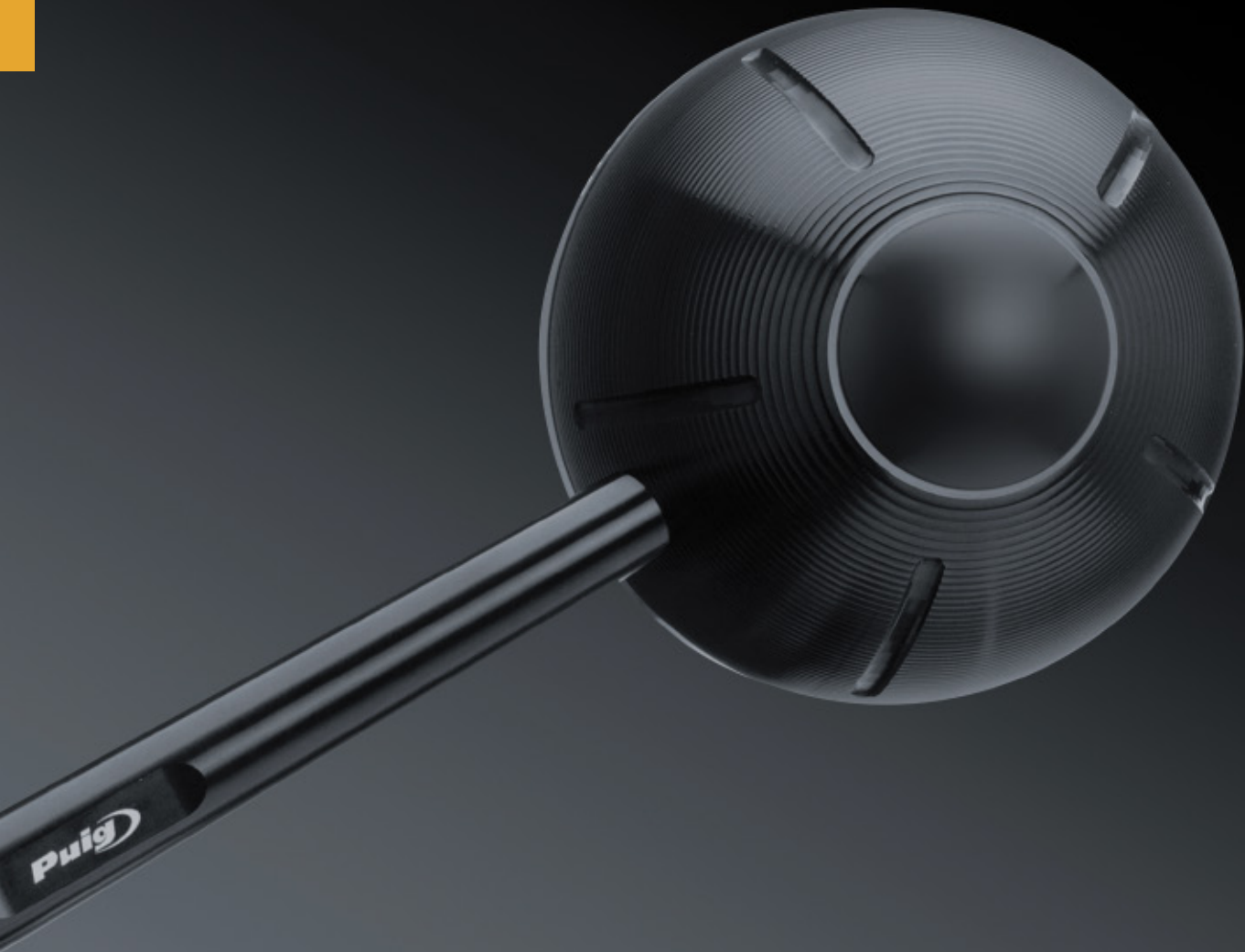

REARVIEW MIRROR HYPERNAKED

HI-TECH PARTS | TECHNICAL SECTION



* Check availability for motorcycle models at www.puig.tv typing in the searching window.

NOT HOMOLOGATED

REF. 9884D



ANTI GLARE GLASS
145 x 48 mm.

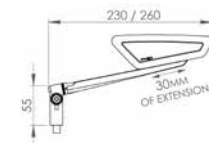

ADJUSTABLE
Inclination, adjustment, and extension of the mirror.

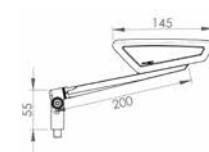
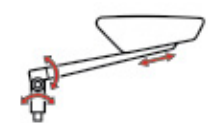

ADAPTABLE
Available adapters for handlebar and fairing fitting.

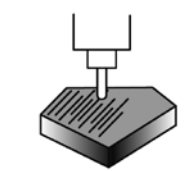

MATERIAL
Manufactured from billet aluminium and anodized.



- N Black
- D Aluminium Anodized

MODEL	SIDE	REF.	N D
UNIVERSAL THREAD M10/125	RIGHT	9883 (#)	(*)
UNIVERSAL THREAD M10/125	LEFT	9884 (+)	(*)

(#) SCREW M10/125+M10/125 REVERSE THREAD + SCREW M8/125 + M8/125 REVERSE THREAD.
(+) SCREW M10/125 + SCREW M8/125.

TO SEE PART# FOR THE ADAPTORS ON THE MODELS AVAILABLE: **CHECK OUR WEBSITE.**
FOR THOSE MODELS REQUIRING ADAPTORS TO ATTACH TO THE FAIRING: **CHECK OUR WEBSITE.**

(*) Check price with your distributor.
IMPORTANT: Indicate code color after part#. Example 0973A.

REARVIEW MIRROR EXPLORER

HI-TECH PARTS | TECHNICAL SECTION



* Check availability for motorcycle models at www.puig.tv typing in the searching window.

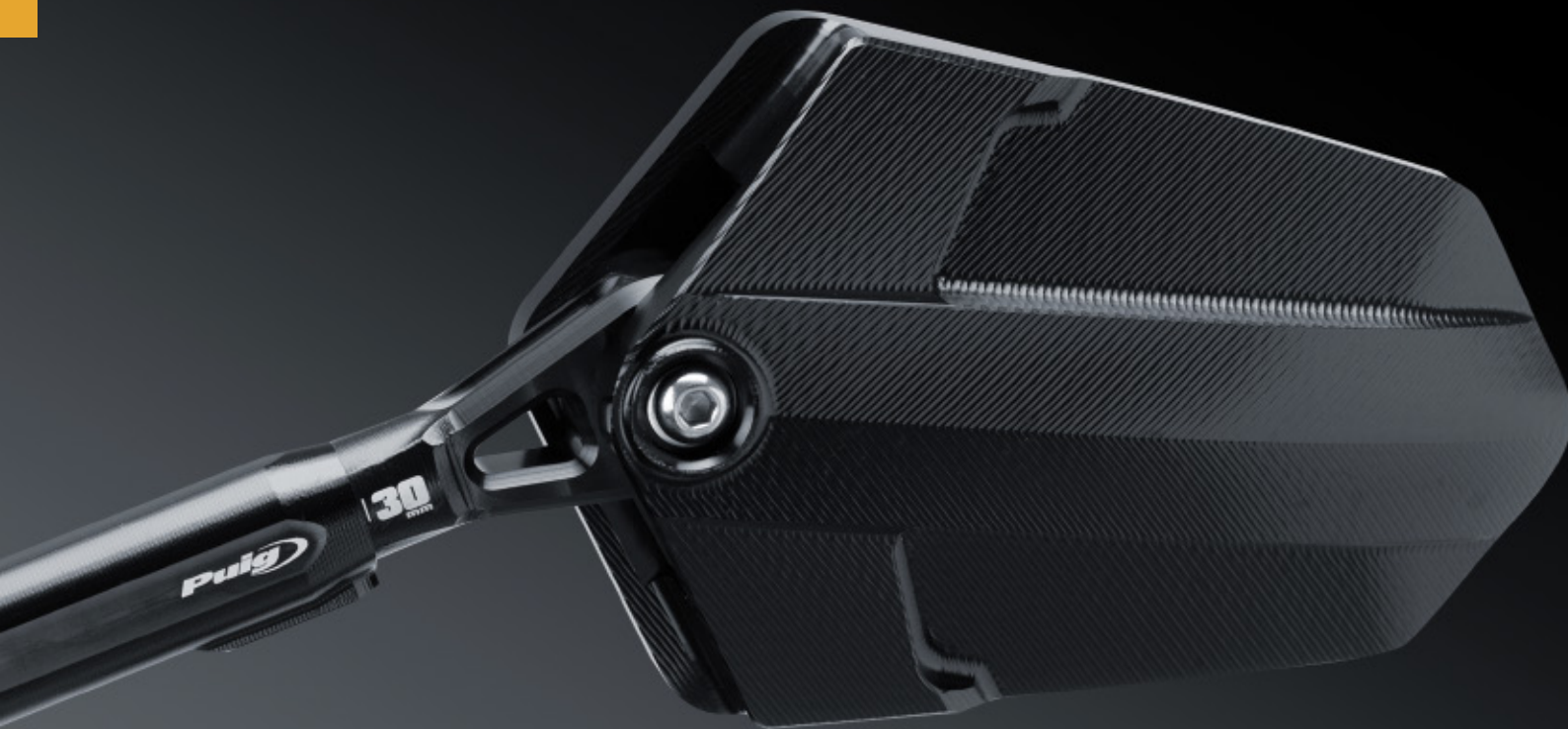

HOMOLOGATED

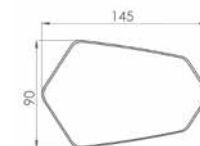

ANTIGLARE GLASS
145 x 90 mm.

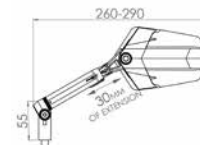

ADJUSTABLE
Inclination, adjustment, and extension of the mirror.

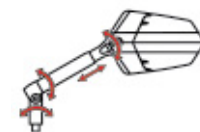

ADAPTABLE
Available adapters for handlebar and fairing fitting.

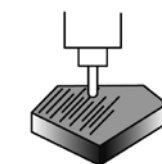

MATERIAL
Manufactured from billet aluminium and anodized.



N Black



D Aluminium Anodized



MODEL	SIDE	REF.	N D
UNIVERSAL THREAD M10/125	RIGHT	010NN (1) (#)	(*)
UNIVERSAL THREAD M10/125	RIGHT	010DD (2) (#)	(*)
UNIVERSAL THREAD M10/125	RIGHT	010DN (3) (#)	(*)
UNIVERSAL THREAD M10/125	RIGHT	010ND (4) (#)	(*)
UNIVERSAL THREAD M10/125	LEFT	014NN (1) (+)	(*)
UNIVERSAL THREAD M10/125	LEFT	014DD (2) (+)	(*)
UNIVERSAL THREAD M10/125	LEFT	014DN (3) (+)	(*)
UNIVERSAL THREAD M10/125	LEFT	014ND (4) (+)	(*)

(#) SCREW M10/125+M10/125 REVERSE THREAD + SCREW M8/125 + M8/125 REVERSE THREAD.
(+) SCREW M10/125 + SCREW M8/125.

TO SEE PART# FOR THE ADAPTORS ON THE MODELS AVAILABLE: [CHECK OUR WEBSITE](#).
FOR THOSE MODELS REQUIRING ADAPTORS TO ATTACH TO THE FAIRING: [CHECK OUR WEBSITE](#).

(*) Check price with your distributor.

IMPORTANT: Indicate code color after part#. Example 0973A.

REARVIEW MIRROR GT.1

HI-TECH PARTS | TECHNICAL SECTION



* Check availability for motorcycle models at www.puig.tv typing in the searching window.



HOMOLOGATED



ANTI-GLARE GLASS

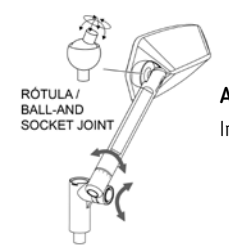

ADJUSTABLE
Inclination and height.

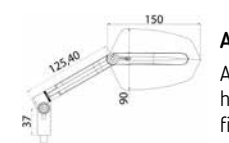

ADAPTABLE
Available adapters for handlebar and fairing fitting.

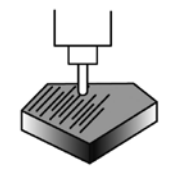

MATERIAL
Manufactured from billet aluminium and anodized.

- N Black
- D Aluminium Anodized

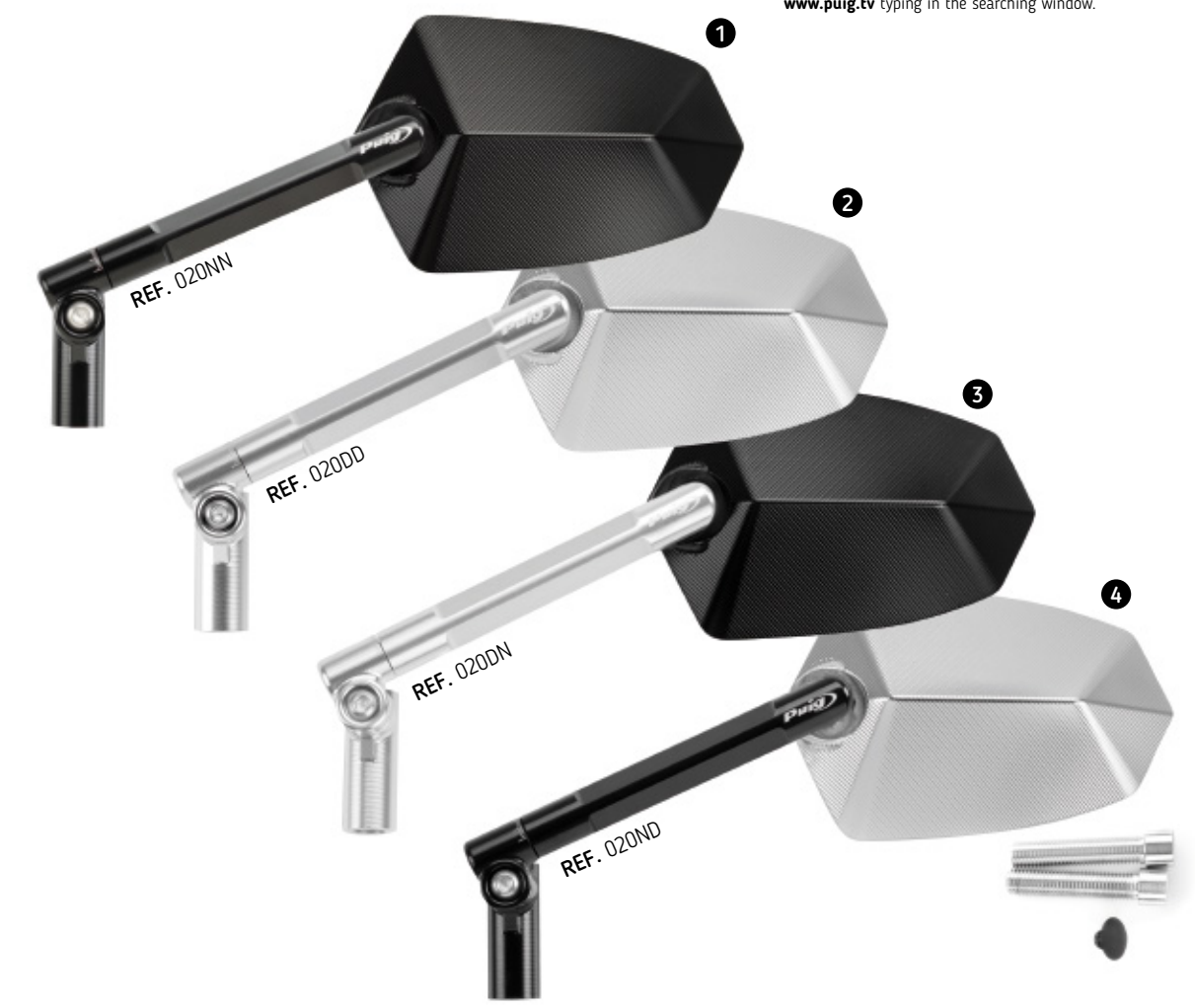

MODEL	SIDE	REF.	N	D
UNIVERSAL THREAD M10/125	RIGHT	020NN (1) (#)	(*)	
UNIVERSAL THREAD M10/125	RIGHT	020DD (2) (#)	(*)	
UNIVERSAL THREAD M10/125	RIGHT	020DN (3) (#)	(*)	
UNIVERSAL THREAD M10/125	RIGHT	020ND (4) (#)	(*)	
UNIVERSAL THREAD M10/125	LEFT	019NN (1) (+)	(*)	
UNIVERSAL THREAD M10/125	LEFT	019DD (2) (+)	(*)	
UNIVERSAL THREAD M10/125	LEFT	019DN (3) (+)	(*)	
UNIVERSAL THREAD M10/125	LEFT	019ND (4) (+)	(*)	

(#) SCREW M10/125+M10/125 REVERSE THREAD + SCREW M8/125 + M8/125 REVERSE THREAD.
(+) SCREW M10/125 + SCREW M8/125.

TO SEE PART# FOR THE ADAPTORS ON THE MODELS AVAILABLE: [CHECK OUR WEBSITE](#).
FOR THOSE MODELS REQUIRING ADAPTORS TO ATTACH TO THE FAIRING: [CHECK OUR WEBSITE](#).

(*) Check price with your distributor.
IMPORTANT: Indicate code color after part#. Example 0973A.

REARVIEW MIRROR GTI

HI-TECH PARTS | TECHNICAL SECTION



* Check availability for motorcycle models at www.puig.tv typing in the searching window.



HOMOLOGATED



ANTI GLARE GLASS

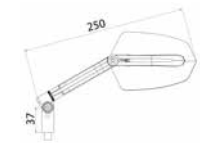

ADJUSTABLE
Inclination and height.

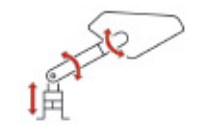

ADAPTABLE
Availbe adapters for handlebar and fairing fitting.

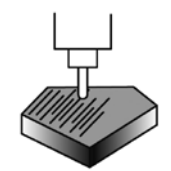

MATERIAL
Manufactured from billet aluminium and anodized.

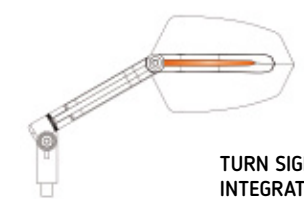

TURN SIGNAL INTEGRATED

- N Black
- D Aluminium Anodized



MODEL	SIDE	REF.	N D
UNIVERSAL THREAD M10/125	RIGHT	015NN (1) (#)	(*)
UNIVERSAL THREAD M10/125	RIGHT	015DD (2) (#)	(*)
UNIVERSAL THREAD M10/125	RIGHT	015DN (3) (#)	(*)
UNIVERSAL THREAD M10/125	RIGHT	015ND (4) (#)	(*)
UNIVERSAL THREAD M10/125	LEFT	016NN (1) (+)	(*)
UNIVERSAL THREAD M10/125	LEFT	016DD (2) (+)	(*)
UNIVERSAL THREAD M10/125	LEFT	016DN (3) (+)	(*)
UNIVERSAL THREAD M10/125	LEFT	016ND (4) (+)	(*)

(#) SCREW M10/125+M10/125 REVERSE THREAD + SCREW M8/125 + M8/125 REVERSE THREAD.
(+) SCREW M10/125 + SCREW M8/125.

TO SEE PART# FOR THE ADAPTORS ON THE MODELS AVAILABLE: [CHECK OUR WEBSITE.](#)
FOR THOSE MODELS REQUIRING ADAPTORS TO ATTACH TO THE FAIRING: [CHECK OUR WEBSITE.](#)

(*) Check price with your distributor.
IMPORTANT: Indicate code color after part#. Example 0973A.

REARVIEW MIRROR F1.1

HI-TECH PARTS | TECHNICAL SECTION

F1.1

* Check availability for motorcycle models at www.puig.tv typing in the searching window.



NOT HOMOLOGATED

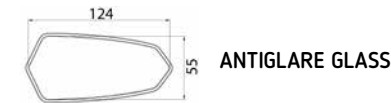

ANTIGLARE GLASS

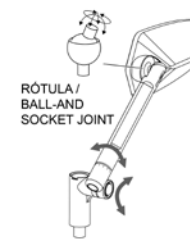

RÓTULA / BALL-AND-SOCKET JOINT

ADJUSTABLE

Inclination and height.

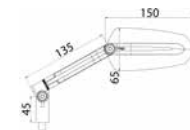

ADAPTABLE

Available adapters for handlebar and fairing fitting.

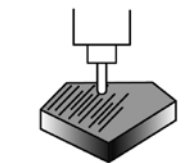

MATERIAL

Manufactured from billet aluminium and anodized.



N Black



D Aluminium Anodized



MODEL	SIDE	REF.	N D
UNIVERSAL THREAD M10/125	RIGHT	017NN (1) (#)	(*)
UNIVERSAL THREAD M10/125	RIGHT	017DD (2) (#)	(*)
UNIVERSAL THREAD M10/125	RIGHT	017DN (3) (#)	(*)
UNIVERSAL THREAD M10/125	RIGHT	017ND (4) (#)	(*)
UNIVERSAL THREAD M10/125	LEFT	018NN (1) (+)	(*)
UNIVERSAL THREAD M10/125	LEFT	018DD (2) (+)	(*)
UNIVERSAL THREAD M10/125	LEFT	018DN (3) (+)	(*)
UNIVERSAL THREAD M10/125	LEFT	018ND (4) (+)	(*)

(#) SCREW M10/125+M10/125 REVERSE THREAD + SCREW M8/125 + M8/125 REVERSE THREAD.
 (+) SCREW M10/125 + SCREW M8/125.

TO SEE PART# FOR THE ADAPTORS ON THE MODELS AVAILABLE: [CHECK OUR WEBSITE](#).
 FOR THOSE MODELS REQUIRING ADAPTORS TO ATTACH TO THE FAIRING: [CHECK OUR WEBSITE](#).

(*) Check price with your distributor.

IMPORTANT: Indicate code color after part#. Example 0973A.



REARVIEW MIRROR RS1

HOMOLOGATED

MODEL	SIDE	REF.	N	C
(1) UNIVERSAL 30° FAIRING FITTING	RIGHT	7342C	(*)	
(1) UNIVERSAL 30° FAIRING FITTING	LEFT	7343C	(*)	
(2) UNIVERSAL FAIRING FITTING	RIGHT	7344	(*)	
(2) UNIVERSAL FAIRING FITTING	LEFT	7345	(*)	
(3) UNIVERSAL 70° FAIRING FITTING	RIGHT	7346	(*)	

N Black

C Carbon look

RS1



* Check availability for motorcycle models at www.puig.tv typing in the searching window.

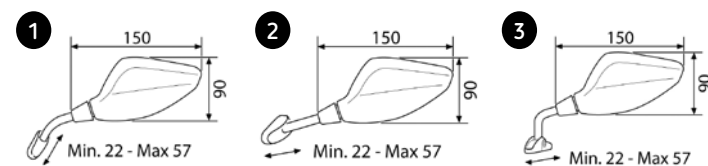

REAR MIRROR WITH PLASTIC BASE.

TO SEE PART# FOR THE ADAPTORS ON THE MODELS AVAILABLE: [CHECK OUR WEBSITE](http://www.puig.tv).
FOR THOSE MODELS REQUIRING ADAPTORS TO ATTACH TO THE FAIRING: [CHECK OUR WEBSITE](http://www.puig.tv).

REARVIEW MIRROR RS2

NOT HOMOLOGATED

MODEL	SIDE	REF.	N	C
(1) UNIVERSAL WITH BAR	RIGHT	7348 (#)	(*)	
(1) UNIVERSAL WITH BAR	LEFT	7349 (#)	(*)	
(2) UNIVERSAL 30° FAIRING FITTING	RIGHT	7350	(*)	
(2) UNIVERSAL 30° FAIRING FITTING	LEFT	7351	(*)	
(3) UNIVERSAL FAIRING FITTING	RIGHT	7352	(*)	
(3) UNIVERSAL FAIRING FITTING	LEFT	7353	(*)	
(4) UNIVERSAL 70° FAIRING FITTING	RIGHT	7354	(*)	
(4) UNIVERSAL 70° FAIRING FITTING	LEFT	7355	(*)	

N Black

C Carbon look

RS2



* Check availability for motorcycle models at www.puig.tv typing in the searching window.

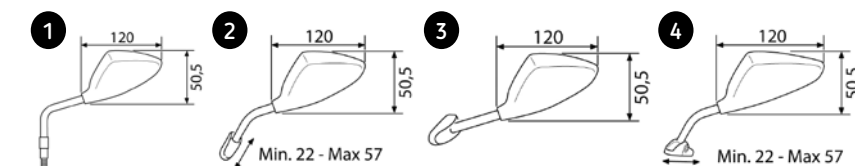

(#) KIT ADAPTER DELIVERED: M10 x 1,25RH, M10 x 1,25LH, M8 x 1,25RH, M8 x 1,25LH.
REAR MIRROR WITH PLASTIC BASE.

TO SEE PART# FOR THE ADAPTORS ON THE MODELS AVAILABLE: [CHECK OUR WEBSITE](http://www.puig.tv).
FOR THOSE MODELS REQUIRING ADAPTORS TO ATTACH TO THE FAIRING: [CHECK OUR WEBSITE](http://www.puig.tv).



REARVIEW MIRROR MT

NOT HOMOLOGATED

MODEL	SIDE	REF.	N	P
UNIVERSAL THREAD M10	RIGHT	4310 (#)	(*)	
UNIVERSAL THREAD M10	LEFT	4311	(*)	

 N Black

 P Silver



REARVIEW MIRROR MG

NOT HOMOLOGATED

MODEL	SIDE	REF.	N
UNIVERSAL THREAD M10	LEFT	4498	(*)

 N Black

TO SEE PART# FOR THE ADAPTORS ON THE MODELS AVAILABLE: [CHECK OUR WEBSITE.](#)



* Check availability for motorcycle models at www.puig.tv typing in the searching window.

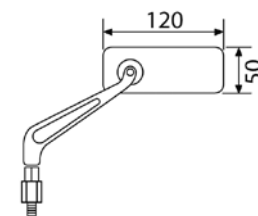

(#) KIT ADAPTER DELIVERED: M10 x 1,25 (reverse thread).
REAR MIRROR WITH ALUMINIUM BASE.

TO SEE PART# FOR THE ADAPTORS ON THE MODELS AVAILABLE: [CHECK OUR WEBSITE.](#)



* Check availability for motorcycle models at www.puig.tv typing in the searching window.

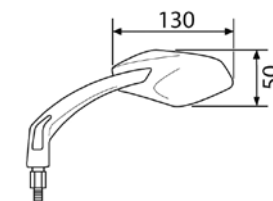

REAR MIRROR WITH ALUMINIUM BASE.

TO SEE PART# FOR THE ADAPTORS ON THE MODELS AVAILABLE: [CHECK OUR WEBSITE.](#)



REARVIEW MIRROR Z1

HOMOLOGATED

MODEL	SIDE	REF.	C
(1) UNIVERSAL THREAD M10 TO HANDLEBAR	RIGHT	4306 (#)	(*)
(1) UNIVERSAL THREAD M10 TO HANDLEBAR	LEFT	4307	(*)
(2) FAIRING FITTING	RIGHT	4251	(*)
(2) FAIRING FITTING	LEFT	4252	(*)

 C Carbon look

Z1



* Check availability for motorcycle models at www.puig.tv typing in the searching window.

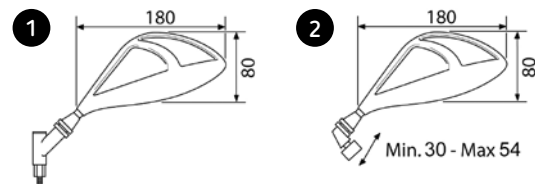

(#) ADAPTOR KIT INCLUDED: M10 x 1,25 (reverse thread).
REAR MIRROR WITH CARBON LOOK BASE.

TO SEE PART# FOR THE ADAPTORS ON THE MODELS AVAILABLE: [CHECK OUR WEBSITE.](#)

REARVIEW MIRROR Z2

HOMOLOGATED

MODEL	SIDE	REF.	N
(1) UNIVERSAL WITH BAR	RIGHT	3574 (#)	(*)
(1) UNIVERSAL WITH BAR	LEFT	3575 (#)	(*)
(2) UNIVERSAL 30° FAIRING FITTING	RIGHT	3576	(*)
(2) UNIVERSAL 30° FAIRING FITTING	LEFT	3577	(*)
(3) UNIVERSAL FAIRING FITTING	RIGHT	3578	(*)
(3) UNIVERSAL FAIRING FITTING	LEFT	3579	(*)
(4) UNIVERSAL 70° FAIRING FITTING	RIGHT	3580	(*)
(4) UNIVERSAL 70° FAIRING FITTING	LEFT	3581	(*)

 N Black

Z2



* Check availability for motorcycle models at www.puig.tv typing in the searching window.

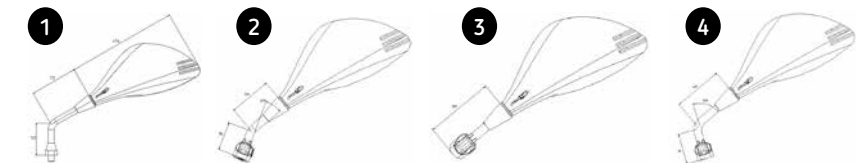

(#) KIT ADAPTER DELIVERED: M10 x 1,25RH, M10 x 1,25LH, M8 x 1,25RH, M8 x 1,25LH.
REAR MIRROR WITH CARBON LOOK BASE.

TO SEE PART# FOR THE ADAPTORS ON THE MODELS AVAILABLE: [CHECK OUR WEBSITE.](#)



ORIGINAL REARVIEW MIRRORS CAPS, SUPPORT AND SHIFTER

HI-TECH PARTS | TECHNICAL SECTION

REF. 7511N



BASE CAPS FOR OEM REAR MIRRORS BY PAIR

MODEL	YEAR	REF.	A N O R
YAMAHA			
T-MAX 530	12' - 16'	7511	(*)
T-MAX 530/DX/SX	17' - 19'	7511	(*)
T-MAX 560 /SX/DX/MAX TECH	20' - 21'	3875	(*)

REF. 7517N



ADAPTOR TO AXLE LEVER

MODEL	YEAR	REF.	N
YAMAHA			
T-MAX 530	12' - 16'	7517	(*)
T-MAX 530/DX/SX	17' - 19'	7517 (#)	(*)
T-MAX 560/DX/SX/TECH MAX	20' - 21'	3883	(*)

(#) FOR T-MAX 530/SX/DX 17' COMPATIBLE ONLY FOR V-TECH LINES SPORT / TOURING PUIG.

REF. REF. 5021N



REARVIEW MIRROR MOVE SET

MODEL	REF.	N
UNIVERSAL DISPLACER MIRROR DIAMETER 10 mm. LEFT SIDE	5021N	(*)
UNIVERSAL REAR MIRROR MOVE SET DIAMETER 10 mm. RIGHT SIDE	5021N	(*)

A Blue
N Black

R Red
O Gold

(*) Check price with your distributor.
IMPORTANT: Indicate code color after part#. Example 0973A.

REARVIEW MIRROR CAPS

HI-TECH PARTS | TECHNICAL SECTION



FUNCTION

Cover the fairing holes when the original rearview mirrors are taken out. Specific models for each motorbike.

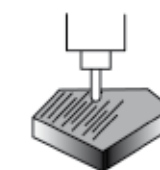

CNC MACHINED

Cover the fairing holes when the original rearview mirrors are taken out. Specific models for each motorbike.



REF. 3845N



REF. 3847N

■ N Black

MODEL	YEAR	REF.	N
DUCATI			
PANIGALE V2	20' - 21'	20427N	(*)
PANIGALE V2 BAYLISS	21'	20427N	(*)
HONDA			
CBR500R	13' - 19'	3854N	(*)
CBR600RR	13' - 16'	3854N	(*)
CBR650F	14'-19'	3854N	(*)
CBR650R	19'	3854N	(*)
CBR1000RR FIREBLADE/SP/SP2	17' - 19'	3843N	(*)
CBR1000RR FIREBLADE/SP/SP2	17' - 19'	3843N	(*)
CBR1000RR FIREBLADE/SP	20' - 21'	3843N	(*)
KAWASAKI			
NINJA 125	19'	3859N	(*)
NINJA 250SL	15'-16'	3859N	(*)
NINJA 400	18'-19'	3859N	(*)
NINJA 650	20' - 21'	3859N	(*)
ZX-10R	16' - 19'	3847N	(*)
ZX-10R	16' - 19'	3847N	(*)
ZX-10R	21'	3847N	(*)
ZX-10RR	17' - 19'	3847N	(*)
ZX-10RR	17' - 19'	3847N	(*)
ZX-10RR	21'	3847N	(*)
SUZUKI			
GSX-R250	17'-19'	3851N	(*)
GSX-R250	17'-19'	3851N	(*)
GSX-R1000/R	17' - 19'	3848N	(*)
GSX-R1000/R	17' - 19'	3848N	(*)
TRIUMPH			
DAYTONA 675/R	13' - 16'	3852N	(*)
DAYTONA 675/R	13' - 16'	3852N	(*)
YAMAHA			
XJ6 DIVERSION	09'-16'	3855N	(*)
YZF-R1	09'-14'	3855N	(*)
YZF-R1	15'-19'	3845N	(*)
YZF-R1	15'-21'	3845N	(*)
YZF-R1M	20' - 21'	3845N	(*)
YZF-R3	15'-19'	3856N	(*)
YZF-R6	06'-16'	3857N	(*)
YZF-R6	06'-16'	3857N	(*)
YZF-R6	17'-19'	3845N	(*)
YZF-R6	17'-19'	3845N	(*)

(*) Check price with your distributor.

IMPORTANT: Indicate code color after part#. Example 0973A.

MOTORCYCLE HANDGUARDS

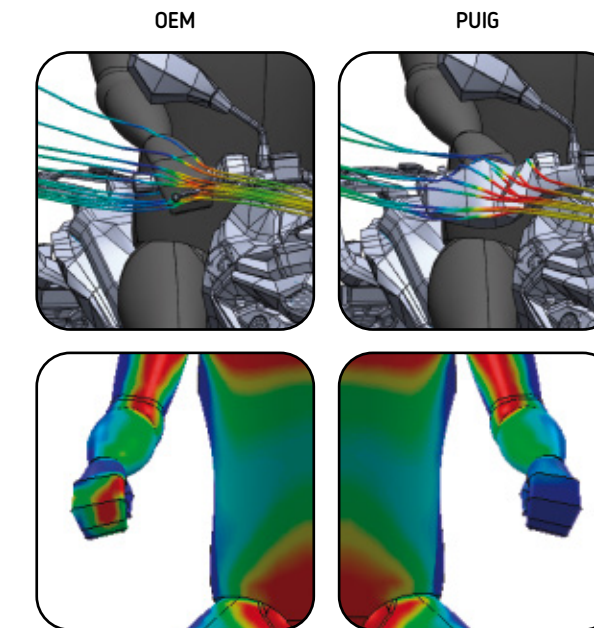
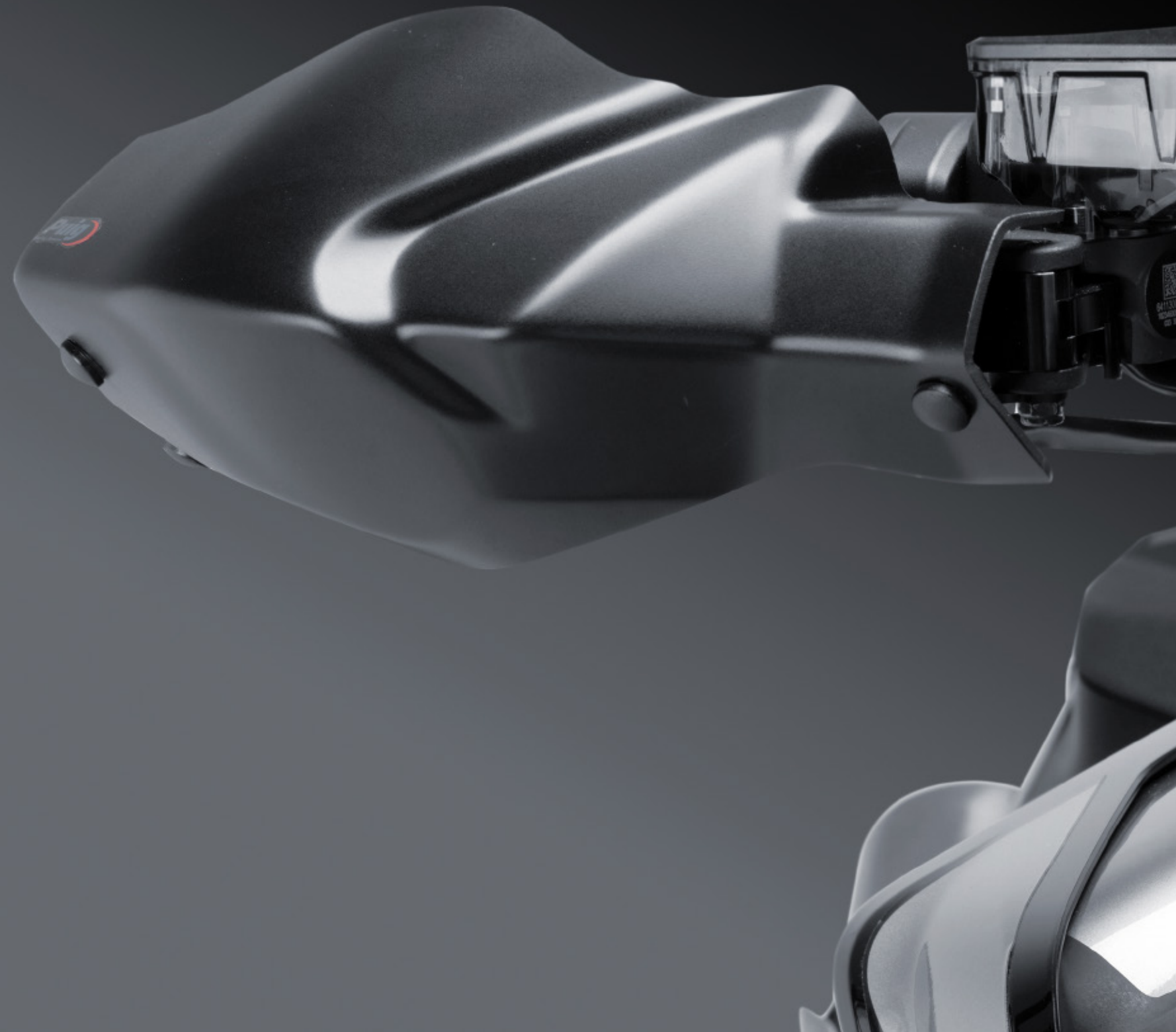

HI-TECH PARTS | TECHNICAL SECTION



Puig offers a wide range of handguards for those motorcycles that do not have them. Manufactured in a matt black plastic material. They are light, durable and matching your motorcycle lines.

Designed with the best aerodynamic software to protect your hands and arms from the rain, air and possible small impacts from small rocks or insects.

Available in two models according to the protection or style you prefer, sport or touring.

-  J Matt black
-  C Carbon look

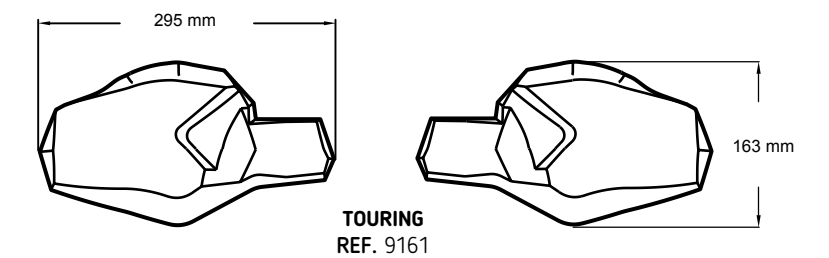
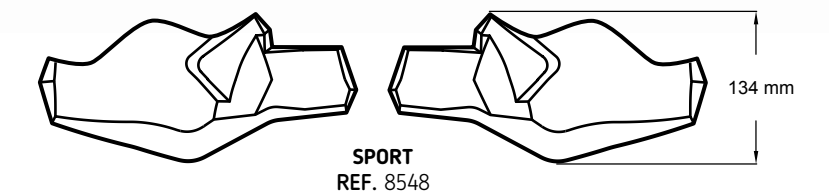

FOR SPECIFIC MODELS SEE PAGE 322.



MOTORCYCLE HANDGUARD EXTENSIONS

HI-TECH PARTS | TECHNICAL SECTION

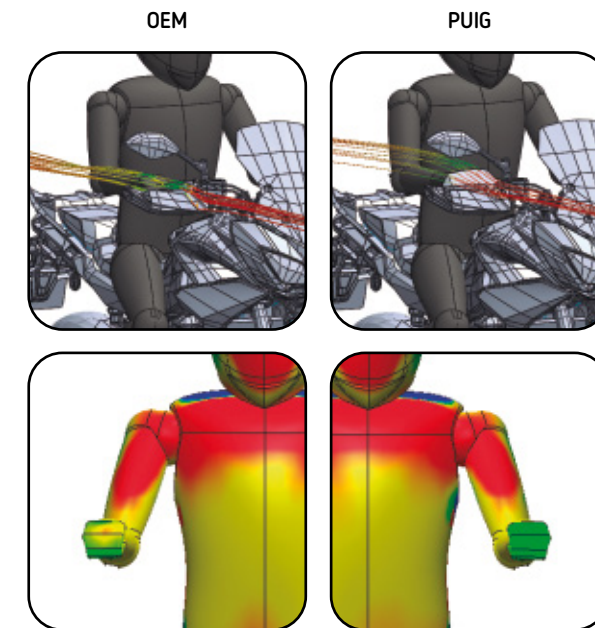

REF. 8184H

The Puig handguard extension is a product destined to the client that looks for maximum protection or that suffers from the impact of the wind on his arms and shoulders.

These small and discrete parts have been specially designed through a comprehensive aerodynamic study to redirect air flow, water or small impacts to your upper arms and thus offering the best riding comfort.

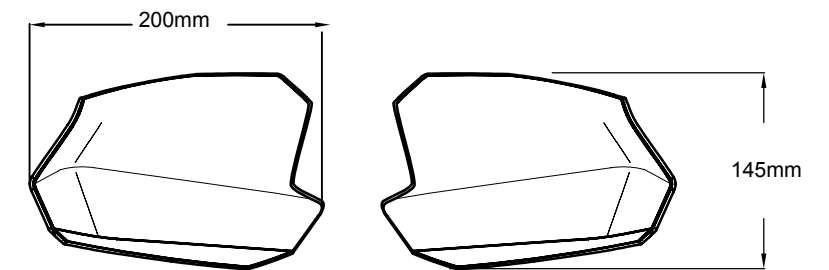

REF. 8184

- H Smoke
- F Dark Smoke
- W Transparent
- T Orange

FOR SPECIFIC MODELS SEE PAGE 322.



MAXISCOOTER HANDGUARDS

HI-TECH PARTS | TECHNICAL SECTION

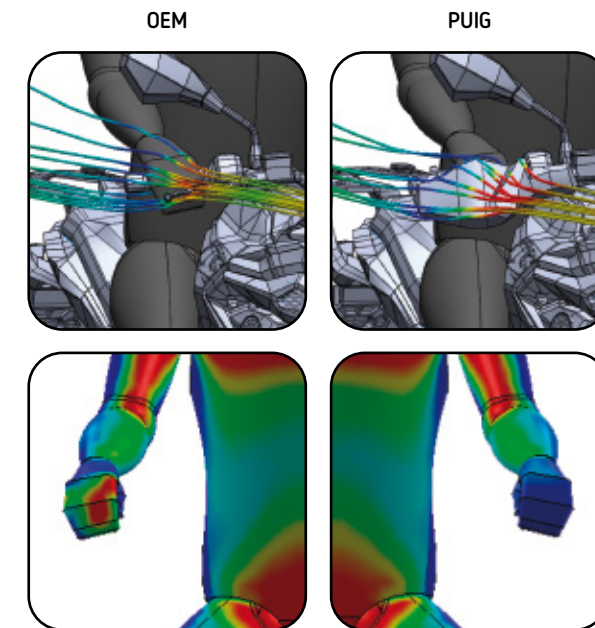

REF. 9652H



Puig offers a line of handguards for Scooters and Maxiscooters. They are fabricated in very durable material, they are light and made with soft and discrete lines that will match your motorcycle perfectly.

Designed with the best aerodynamic software to protect your hands and arms from the rain, air and possible small impacts from small rocks or insects.

Available in three shades, smoke, dark smoke and transparent.

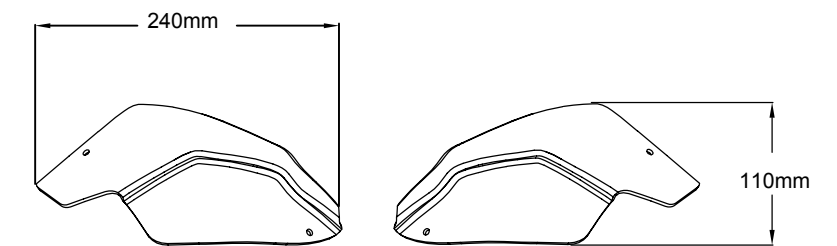

REF. 9652

- H Smoke
- F Dark Smoke
- W Transparent

FOR SPECIFIC MODELS SEE PAGE 322.

HANDGUARDS

HI-TECH PARTS | TYPE OF HANDGUARDS:

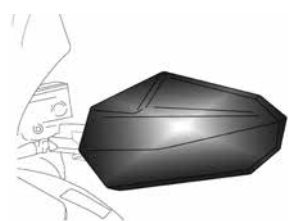

MAXISCOOTER HANDGUARDS

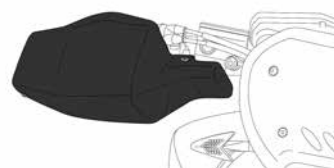

MOTORCYCLE HANDGUARDS

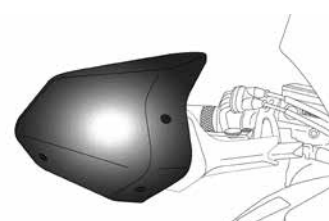

EXTENSION MOTORCYCLE HANDGUARDS

* To be mounted with the complete OEM Handguards.

2022									
For the new 2022 motorcycle models check www.puig.tv									
MODEL	YEAR	TYPE OF HANGUARDS	MATERIAL	ADHESIVE KIT	REF.	J	C	F	W
BENELLI									
TRK 502	16' - 21'	MOTORCYCLE TOURING	ABS		20622	(*)			
TRK 502X	16' - 21'	MOTORCYCLE TOURING	ABS		20622	(*)			
TRK 251	20' - 21'	MOTORCYCLE TOURING	ABS		20622	(*)			
BMW									
F750 GS	18' - 21'	EXTENSION	PMMA	NOT INCLUDED	3763				(*)
F800 R	15' - 19'	MOTORCYCLE TOURING	ABS	INCLUDED	8939	(*)			
F800 GS	13' - 17'	MOTORCYCLE TOURING	ABS	INCLUDED	8939	(*)			
F800GS ADVENTURE	13' - 18'	EXTENSION	PMMA	NOT INCLUDED	3763				(*)
F850GS	18' - 21'	EXTENSION	PMMA	NOT INCLUDED	3763				(*)
F850GS ADVENTURE	19' - 21'	EXTENSION	PMMA	NOT INCLUDED	3763				(*)
F900XR	20' - 21'	EXTENSION	PMMA	NOT INCLUDED	3763				(*)
G310 GS	17' - 21'	MOTORCYCLE TOURING	ABS	INCLUDED	9881	(*)			
G310 R	16' - 21'	MOTORCYCLE TOURING	ABS	INCLUDED	9881	(*)			
G650 GS	11' - 16'	MOTORCYCLE TOURING	ABS	INCLUDED	8937				
R1200 GS	13' - 18'	EXTENSION	PMMA	NOT INCLUDED	3763				(*)
R1200GS EXCLUSIVE	17' - 18'	EXTENSION	PMMA	NOT INCLUDED	3763				(*)
R1200GS RALLYE	17' - 18'	EXTENSION	PMMA	NOT INCLUDED	3763				(*)
R1200GS ADVENTURE	14' - 18'	EXTENSION	PMMA	NOT INCLUDED	3763				(*)
R1200 R	15' - 18'	MOTORCYCLE TOURING	ABS	INCLUDED	8940	(*)			
R1250GS	18' - 21'	EXTENSION	PMMA	NOT INCLUDED	3763				(*)
R1250GS HP	18' - 21'	EXTENSION	PMMA	NOT INCLUDED	3763				(*)
R1250GS ADVENTURE	18' - 21'	EXTENSION	PMMA	NOT INCLUDED	3763				(*)
R1250GS RALLYE	18' - 21'	EXTENSION	PMMA	NOT INCLUDED	3763				(*)
R1250R	19' - 21'	MOTORCYCLE TOURING	ABS	INCLUDED	8940	(*)			
R NINE T	14' - 20'	MOTORCYCLE TOURING	ABS	INCLUDED	9393	(*)			
R NINE T SCRAMBLER	15' - 20'	MOTORCYCLE TOURING	ABS	INCLUDED	9393	(*)			
S1000 XR	15' - 19'	EXTENSION	PMMA	NOT INCLUDED	3763				(*)
S1000 XR	20' - 21'	EXTENSION	PMMA	NOT INCLUDED	3763				(*)

2022									
For the new 2022 motorcycle models check www.puig.tv									
MODEL	YEAR	TYPE OF HANGUARDS	MATERIAL	ADHESIVE KIT	REF.	J	C	F	W
DUCATI									
MULTISTRADA V4/S/S SPORT	21'	EXTENSION			20772				(*)
SCRAMBLER DESERT SLED	17' - 20'	MOTORCYCLE TOURING	ABS	INCLUDED	20509	(*)			
SCRAMBLER ICON/CLASSIC/FULL THROTTLE	15' - 21'	MOTORCYCLE TOURING	ABS	INCLUDED	20509	(*)			
SCRAMBLER SIXTY2	16' - 21'	MOTORCYCLE TOURING	ABS	INCLUDED	8949	(*)			
HONDA									
CB500F	16 - 21'	MOTORCYCLE TOURING	ABS	INCLUDED	9236	(*)			
CB500X	13' - 18'	MOTORCYCLE TOURING	ABS	INCLUDED	8943	(*)			
CB650F	14' - 16'	MOTORCYCLE TOURING	ABS	INCLUDED	8944	(*)			
CROSSRUNNER	15' - 21'	MOTORCYCLE TOURING	ABS	INCLUDED	8946	(*)			
CRF1000L AFRICA TWIN	16' - 19'	EXTENSION	PMMA	NOT INCLUDED	8948				(*)
CRF1100L AFRICA TWIN	20' - 21'	EXTENSION	PMMA	NOT INCLUDED	3824				(*)
CRF1100L AFRICA TWIN ADVENTURE SPORTS	20' - 21'	EXTENSION	PMMA	NOT INCLUDED	3824				(*)
FORZA 125	15' - 20'	MAXISCOOTER	PMMA	NOT INCLUDED	9652				(*)
FORZA 125	21'	MAXISCOOTER	PMMA	NOT INCLUDED	3488				(*)
FORZA 300	18' - 20'	MAXISCOOTER	PMMA	NOT INCLUDED	9652				(*)
FORZA 350	21'	MAXISCOOTER	PMMA	NOT INCLUDED	3488				(*)
INTEGRA 750	14' - 21'	MAXISCOOTER	PMMA	NOT INCLUDED	9652				(*)
INTEGRA 750S	14' - 21'	MAXISCOOTER	PMMA	NOT INCLUDED	9652				(*)
NC700X	12' - 13'	MOTORCYCLE TOURING	ABS	INCLUDED	8549	(*)			
NC750S	16' - 21'	MOTORCYCLE TOURING	ABS	INCLUDED	8549	(*)			
NC750X	14' - 20'	MOTORCYCLE TOURING	ABS	INCLUDED	8549	(*)			
PCX 125	14' - 21'	MAXISCOOTER	PMMA	NOT INCLUDED	9652				(*)
PCX 150	18' - 21'	MAXISCOOTER	PMMA	NOT INCLUDED	9652				(*)
X-ADV	17' - 21'	MAXISCOOTER	PMMA	NOT INCLUDED	9652				(*)
X-ADV	17' - 21'	EXTENSION	PMMA	INCLUDED	3621				(*)
KAWASAKI									
J125	16' - 21'	MAXISCOOTER	PMMA	NOT INCLUDED	3488				(*)
J300	14' - 21'	MAXISCOOTER	PMMA	NOT INCLUDED	3488				(*)
VERSYS 650	10' - 14'	MOTORCYCLE TOURING	ABS	INCLUDED	8952	(*)			
VERSYS 650	15' - 21'	MOTORCYCLE TOURING	ABS	INCLUDED	8951	(*)			
VERSYS 1000	15' - 18'	MOTORCYCLE TOURING	ABS	INCLUDED	8951	(*)			
Z650	17' - 21'	MOTORCYCLE TOURING	ABS	INCLUDED	9398	(*)			
Z900	17' - 21'	MOTORCYCLE TOURING	ABS	INCLUDED	9398	(*)			
KTM									
250 ADVENTURE	21'	EXTENSION	PMMA	NOT INCLUDED	9622				(*)
390 ADVENTURE	20' - 21'	EXTENSION	PMMA	NOT INCLUDED	9622				(*)

- J Matt black
- W Transparent
- F Dark Smoke
- H Smoke
- N Orange
- C Carbon look

(*) Check price with your distributor.
IMPORTANT: Indicate code color after part#. Example 0973A.

HANDGUARDS

HI-TECH PARTS | TYPE OF HANDGUARDS:

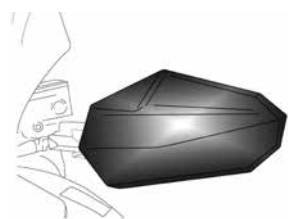

MAXISCOOTER HANDGUARDS

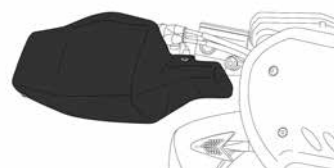

MOTORCYCLE HANDGUARDS

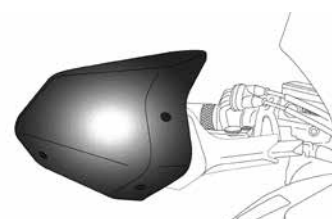

EXTENSION MOTORCYCLE HANDGUARDS

* To be mounted with the complete OEM Handguards.

2022		For the new 2022 motorcycle models check www.puig.tv									
MODEL	YEAR	TYPE OF HANGUARDS	MATERIAL	ADHESIVE KIT	REF.	J	C	F	W	T	H
690 DUKE	16' - 18'	EXTENSION	PMMA	NOT INCLUDED	9622						(*)
690 DUKE R	16' - 17'	EXTENSION	PMMA	NOT INCLUDED	9622						(*)
690 ENDURO R	19' - 20'	EXTENSION	PMMA	NOT INCLUDED	9622						(*)
690 SMC R	19' - 20'	EXTENSION	PMMA	NOT INCLUDED	9622						(*)
790 ADVENTURE/R	19' - 21'	EXTENSION	PMMA	NOT INCLUDED	3589						(*)
790 ADVENTURE R RALLY	20' - 21'	EXTENSION	PMMA	NOT INCLUDED	9622						(*)
790 DUKE	18' - 21'	EXTENSION	PMMA	NOT INCLUDED	9622						(*)
790 DUKE	18' - 21'	MOTORCYCLE TOURING	ABS	INCLUDED	0072	(*)					
890 ADVENTURE	21'	EXTENSION	PMMA	NOT INCLUDED	3589						(*)
890 ADVENTURE R	21'	EXTENSION	PMMA	NOT INCLUDED	3589						(*)
890 ADVENTURE R RALLY	21'	EXTENSION	PMMA	NOT INCLUDED	3589						(*)
890 DUKE R	20' - 21'	EXTENSION	PMMA	NOT INCLUDED	9622						(*)
990 SUPERMOTO	08' - 13'	EXTENSION	PMMA	NOT INCLUDED	9622						(*)
990 SUPERMOTO R	09' - 13'	EXTENSION	PMMA	NOT INCLUDED	9622						(*)
1050 ADVENTURE	15' - 16'	EXTENSION	PMMA	NOT INCLUDED	9622						(*)
1090 ADVENTURE/R	17' - 20'	EXTENSION	PMMA	NOT INCLUDED	9622						(*)
1190 ADVENTURE/R	13' - 16'	EXTENSION	PMMA	NOT INCLUDED	9622						(*)
1290 SUPERDUKE R	14' - 21'	EXTENSION	PMMA	NOT INCLUDED	9622						(*)
1290 SUPERDUKE GT	16' - 20'	MOTORCYCLE TOURING	ABS	INCLUDED	9186	(*)					
1290 SUPER ADVENTURE	15' - 16'	EXTENSION	PMMA	NOT INCLUDED	9622						(*)
1290 SUPER ADVENTURE T	17'	EXTENSION	PMMA	NOT INCLUDED	9622						(*)
1290 SUPER ADVENTURE R	17' - 20'	EXTENSION	PMMA	NOT INCLUDED	9622						(*)
1290 SUPER ADVENTURE S	17' - 20'	EXTENSION	PMMA	NOT INCLUDED	9622						(*)
KYMCO											
AK550	17' - 21'	MAXISCOOTER	PMMA	NOT INCLUDED	9652						(*)
DOWNTOWN 125i	09' - 14'	MAXISCOOTER	PMMA	NOT INCLUDED	9652						(*)
DOWNTOWN 300i	09' - 14'	MAXISCOOTER	PMMA	NOT INCLUDED	9652						(*)
GRAND DINK 125	16' - 20'	MAXISCOOTER	PMMA	NOT INCLUDED	9652						(*)
GRAND DINK 300	16' - 21'	MAXISCOOTER	PMMA	NOT INCLUDED	9652						(*)

2022		For the new 2022 motorcycle models check www.puig.tv									
MODEL	YEAR	TYPE OF HANGUARDS	MATERIAL	ADHESIVE KIT	REF.	J	C	F	W	T	H
G-DINK 50	12' - 18'	MAXISCOOTER	PMMA	NOT INCLUDED	9652						(*)
G-DINK 125i	12' - 18'	MAXISCOOTER	PMMA	NOT INCLUDED	9652						(*)
G-DINK 300i	12' - 18'	MAXISCOOTER	PMMA	NOT INCLUDED	9652						(*)
K-XCT 125i	13' - 16'	MAXISCOOTER	PMMA	NOT INCLUDED	9652						(*)
K-XCT 300i	13' - 16'	MAXISCOOTER	PMMA	NOT INCLUDED	9652						(*)
NEW DOWNTOWN 125i	15' - 20'	MAXISCOOTER	PMMA	NOT INCLUDED	9652						(*)
NEW DOWNTOWN 350i	15' - 20'	MAXISCOOTER	PMMA	NOT INCLUDED	9652						(*)
SUPERDINK 125i	09' - 21'	MAXISCOOTER	PMMA	NOT INCLUDED	9652						(*)
SUPERDINK 350i	09' - 21'	MAXISCOOTER	PMMA	NOT INCLUDED	9652						(*)
XCITING 400i	14' - 16'	MAXISCOOTER	PMMA	NOT INCLUDED	9652						(*)
XCITING S 400	19' - 21'	MAXISCOOTER	PMMA	NOT INCLUDED	9652						(*)
X-TOWN 125	16' - 20'	MAXISCOOTER	PMMA	NOT INCLUDED	9652						(*)
X-TOWN 300	16' - 20'	MAXISCOOTER	PMMA	NOT INCLUDED	9652						(*)
YAGER GT 125i	13' - 18'	MAXISCOOTER	PMMA	NOT INCLUDED	9652						(*)
YAGER GT 300i	13' - 18'	MAXISCOOTER	PMMA	NOT INCLUDED	9652						(*)
SUZUKI											
BURGMAN 125	10' - 20'	MAXISCOOTER	PMMA	NOT INCLUDED	9652						(*)
BURGMAN 400	17' - 21'	MAXISCOOTER	PMMA	NOT INCLUDED	9652						(*)
DL1000 V-STROM	14' - 16'	MOTORCYCLE TOURING	ABS	INCLUDED	8950	(*)					
TRIUMPH											
SPEED TRIPLE/R	16' - 20'	MOTORCYCLE TOURING	ABS	INCLUDED	9255						
TIGER 800	11' - 14'	MOTORCYCLE TOURING	ABS	INCLUDED	8953	(*)					
TIGER 800 XC	11' - 14'	MOTORCYCLE TOURING	ABS	INCLUDED	8953	(*)					
TIGER 800 XC/XCX/XCA	15' - 20'	MOTORCYCLE TOURING	ABS	INCLUDED	8953	(*)					
TIGER 800 XR/XRX/XRT	15' - 20'	MOTORCYCLE TOURING	ABS	INCLUDED	8953	(*)					
TIGER 900	20' - 21'	EXTENSION	PMMA		20378						(*)
TIGER 900 GT	20' - 21'	EXTENSION	PMMA		20378						(*)
TIGER 900 GT LOW	20' - 21'	EXTENSION	PMMA		20378						(*)
TIGER 900 GT PRO	20' - 21'	EXTENSION	PMMA		20378						(*)
TIGER 900 RALLY	20' - 21'	EXTENSION	PMMA		20378						(*)
TIGER 900 RALLY PRO	20' - 21'	EXTENSION	PMMA		20378						(*)
YAMAHA											
MT-03	16' - 21'	MOTORCYCLE SPORT	ABS	INCLUDED	8897	(*)	(*)				
MT-07	14' - 20'	MOTORCYCLE TOURING	ABS	INCLUDED	8548	(*)					
MT-07	14' - 20'	MOTORCYCLE SPORT	ABS	INCLUDED	9161	(*)	(*)				
MT-07 TRACER	16 - 19'	EXTENSION	PMMA	NOT INCLUDED	9214						(*)
MT-07 TRACER	20' - 21'	EXTENSION	PMMA	NOT INCLUDED	20436						(*)

J Matt black
 W Transparent
 F Dark Smoke

H Smoke
 N Orange
 C Carbon look

(*) Check price with your distributor.
 IMPORTANT: Indicate code color after part#. Example 0973A.

HANDGUARDS

HI-TECH PARTS | TYPE OF HANDGUARDS:

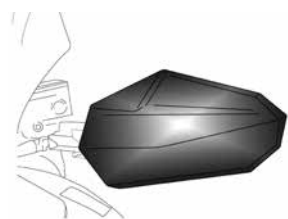

MAXISCOOTER HANDGUARDS

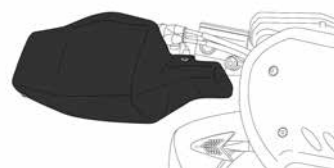

MOTORCYCLE HANDGUARDS

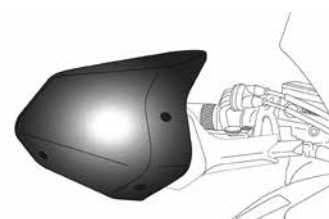

EXTENSION MOTORCYCLE HANDGUARDS

* To be mounted with the complete OEM Handguards.

2022		For the new 2022 motorcycle models check www.puig.tv							
MODEL	YEAR	TYPE OF HANGUARDS	MATERIAL	ADHESIVE KIT	REF.	J	C	F W T H	
MT-07 TRACER GT	19'	EXTENSION	PMMA	NOT INCLUDED	9214			(*)	
MT-07 TRACER GT	20' - 21'	EXTENSION	PMMA	NOT INCLUDED	20436			(*)	
MT-09	13' - 20'	MOTORCYCLE TOURING	ABS	INCLUDED	8548	(*)			
MT-09	13' - 20'	MOTORCYCLE SPORT	ABS	INCLUDED	9161	(*)	(*)		
MT-09 SP	18' - 20'	MOTORCYCLE TOURING	ABS	INCLUDED	8548	(*)			
MT-09 SP	18' - 20'	MOTORCYCLE SPORT	ABS	INCLUDED	9161	(*)	(*)		
MT-09 TRACER	15' - 17'	EXTENSION	PMMA	NOT INCLUDED	8184			(*)	
MT-09 TRACER	18' - 20'	EXTENSION	PMMA	NOT INCLUDED	9727			(*)	
MT-09 TRACER GT	18' - 20'	EXTENSION	PMMA	NOT INCLUDED	9727			(*)	
MT-10	16' - 21'	MOTORCYCLE TOURING	ABS	INCLUDED	8548	(*)			
MT-10	16' - 21'	MOTORCYCLE SPORT	ABS	INCLUDED	9161	(*)	(*)		
MT-10 SP	17' - 21'	MOTORCYCLE TOURING	ABS	INCLUDED	8548	(*)			
MT-10 SP	17' - 21'	MOTORCYCLE SPORT	ABS	INCLUDED	9161	(*)	(*)		
NMAX 125	15' - 20'	MAXISCOOTER	PMMA	NOT INCLUDED	9652			(*)	
NMAX 125	21'	MAXISCOOTER	PMMA	NOT INCLUDED	3488			(*)	
NMAX 155	21'	MAXISCOOTER	PMMA	NOT INCLUDED	3488			(*)	
TENERE 700	19' - 21'	EXTENSION	PMMA	NOT INCLUDED	3729			(*)	
TENERE 700 RALLY EDITION	21'	EXTENSION	PMMA	NOT INCLUDED	3729			(*)	
T-MAX 530	12' - 16'	MAXISCOOTER	PMMA	NOT INCLUDED	8200			(*)	
T-MAX 530/DX/SX	17' - 19'	MAXISCOOTER	PMMA	NOT INCLUDED	8200			(*)	
T-MAX 530/DX/SX	17' - 19'	MAXISCOOTER	PMMA	NOT INCLUDED	3488			(*)	
T-MAX 560/DX/SX/TECH MAX	20' - 21'	MAXISCOOTER	PMMA	NOT INCLUDED	8200			(*)	
T-MAX 560/DX/SX/TECH MAX	20' - 21'	MAXISCOOTER	PMMA	NOT INCLUDED	9652			(*)	
X-MAX 125	14' - 21'	MAXISCOOTER	PMMA	NOT INCLUDED	8111			(*)	
X-MAX 250	14' - 16'	MAXISCOOTER	PMMA	NOT INCLUDED	8111			(*)	
X-MAX 300	17' - 21'	MAXISCOOTER	PMMA	NOT INCLUDED	8111			(*)	
X-MAX 400	13' - 21'	MAXISCOOTER	PMMA	NOT INCLUDED	8111			(*)	
XSR 700	16' - 21'	MOTORCYCLE TOURING	ABS	INCLUDED	8548	(*)			
XSR 700	16' - 21'	MOTORCYCLE SPORT	ABS	INCLUDED	9161	(*)	(*)		

2022		For the new 2022 motorcycle models check www.puig.tv							
MODEL	YEAR	TYPE OF HANGUARDS	MATERIAL	ADHESIVE KIT	REF.	J	C	F W T H	
XSR 900	16' - 21'	MOTORCYCLE TOURING	ABS	INCLUDED	8548	(*)			
XSR 900	16' - 21'	MOTORCYCLE SPORT	ABS	INCLUDED	9161	(*)	(*)		

-  J Matt black
-  W Transparent
-  F Dark Smoke
-  H Smoke
-  N Orange
-  C Carbon look

(*) Check price with your distributor.
IMPORTANT: Indicate code color after part#. Example 0973A.

HANDLEBAR DEFLECTORS

HI-TECH PARTS | TECHNICAL SECTION



REF. 9397



- H Smoke
- W Transparent
- F Dark Smoke

2022		For the new 2022 motorcycle models check www.puig.tv			
MODEL	YEAR	REF.	H	F	W
BMW					
F750GS	18' - 21'	1319			(*)
F850GS	18' - 21'	1319			(*)
F850GS ADVENTURE	19' - 21'	1319			(*)
F900R	20' - 21'	1319			(*)
F900XR	20' - 21'	1319			(*)
R1200GS	13' - 18'	9397			(*)
R1200GS ADVENTURE	14' - 18'	9397			(*)
R1200GS EXCLUSIVE	17' - 18'	9397			(*)
R1200GS RALLYE	17' - 18'	9397			(*)
R1250GS	18' - 21'	9397			(*)
R1250GS ADVENTURE	18' - 21'	9397			(*)
R1250GS HP	18' - 21'	9397			(*)
R1250GS RALLYE	18' - 21'	9397			(*)
S1000 XR	15' - 18'	9397			(*)

(*) Check price with your distributor.
 IMPORTANT: Indicate code color after part#. Example 0973A.



MOBILE PHONE SUPPORT

HI-TECH PARTS | TECHNICAL SECTION

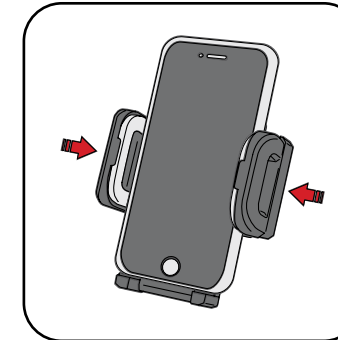
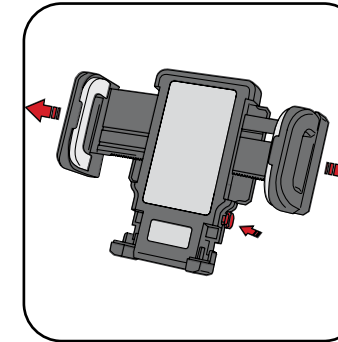
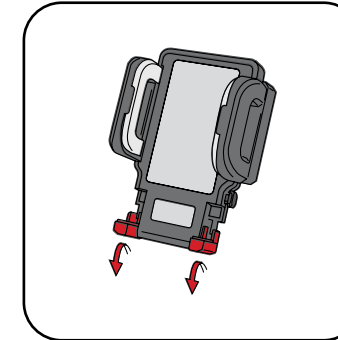
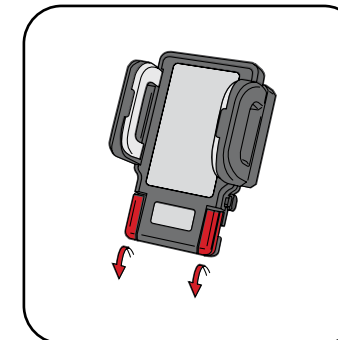

 N Black



REF. 3836N

HORIZONTAL SMARTPHONE PHONE HOLDER

Thanks to the Puig phone holder you can use your smartphone as a browser without suffering for its integrity and security. In addition, in our catalog you will find a line of accessories related to your mobile phone and its protection during journeys of all kinds and with different weather scenarios.

The support will allow you to integrate your phone comfortably and without affecting the final visibility of the road. The locking mechanism adapts to the inches of today's phones. The padded area on the sides and the back, where it rests, improves its grip, and prevents vibration that could affect its operating system.

You can mount the phone holder on the base of the mirror, the mirror rod, on the handlebar and on the seat post of the motorcycle where it will be more immobilized against possible impacts or potholes on the road.

MODEL	DIMENSIONS (mm.)	REF.	N
UNIVERSAL			
MOBILE PHONE SUPPORT	110 x 50-115	3836N	(*)

(*) Check price with your distributor.
IMPORTANT: Indicate code color after part#. Example 0973A.



MOBILE CASE

HI-TECH PARTS | TECHNICAL SECTION



REF. 3531N
TACTILE

185 mm
30 mm
100 mm

LARGE MOBILE CASE

MODEL	DIMENSIONS (mm.)	REF.	N
UNIVERSAL			
MOBILE CASE	185 x 100	3531N	(*)



REF. 3530N
TACTILE

165 mm
30 mm
100 mm

SMALL MOBILE CASE

MODEL	DIMENSIONS (mm.)	REF.	N
UNIVERSAL			
MOBILE CASE	165 x 100	3530N	(*)



REF. 6390N

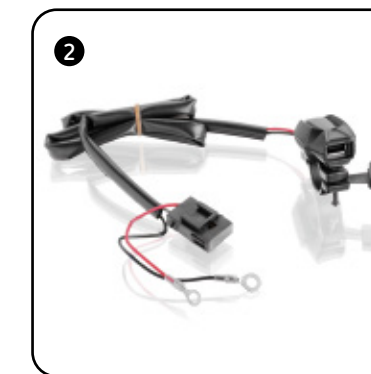

REF. 6840N

IN-TAKE CHARGE

MODEL	REF.	N
(1) IN-TAKE CHARGE C/BLACK	6390N	(*)
(2) USB IN-TAKE CHARGE N/BLACK INPUT:12v OUTPUT:2.5A	6840N	(*)

 N Black

(*) Check price with your distributor.
IMPORTANT: Indicate code color after part#. Example 0973A.



MOBILE SUPPORT BRAKE-CLUTCH LIQUID CAP

HI-TECH PARTS | TECHNICAL SECTION

NEW!

MOBILE SUPPORTS 

* Check availability for motorcycle models at www.puig.tv typing in the searching window.

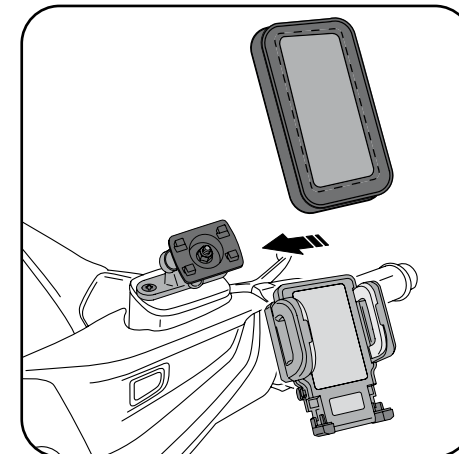
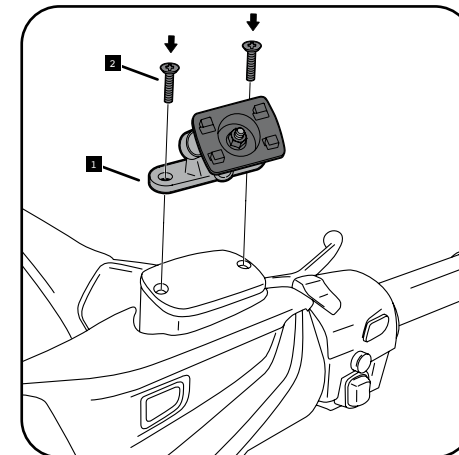
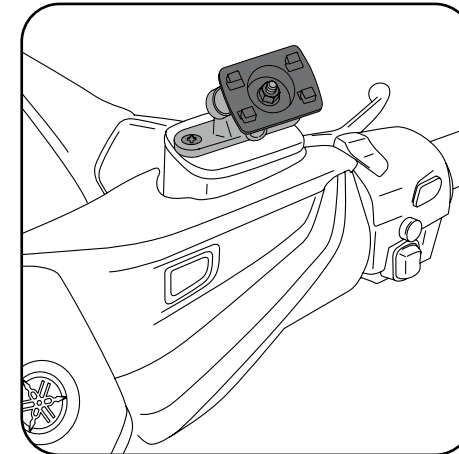

REF. 3830N

SUPPORT BRAKE-CLUTCH LIQUID CAP

MODEL	REF.	N
UNIVERSAL		
SUPPORT BRAKE-CLUTCH LIQUID CAP	3830N	(*)

Specific support for certain motorcycle models made of aluminum and anodized in black. It is fixed on the upper part of the front brake expansion tank cover ensuring good visibility of the device and the motorcycle control panel.

Compatible with the mobile phone holder Ref.3836N and the Puig Motoplastic quick-fix covers Ref.3530N and 3531N.

Available for a wide range of models, consult adjustability to the motorcycle model in the web.

 N Black

(*) Check price with your distributor.
IMPORTANT: Indicate code color after part#. Example 0973A.



MOBILE SUPPORTS

HI-TECH PARTS | TECHNICAL SECTION



* Check availability for motorcycle models at www.puig.tv typing in the searching window.

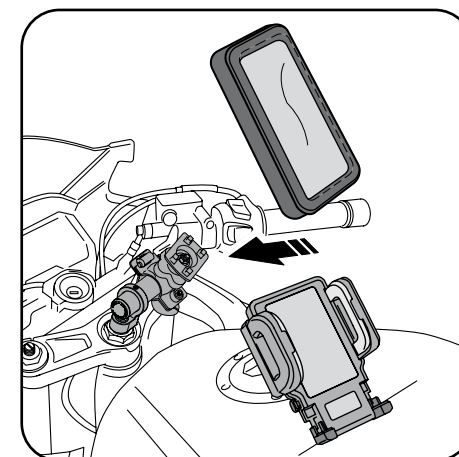
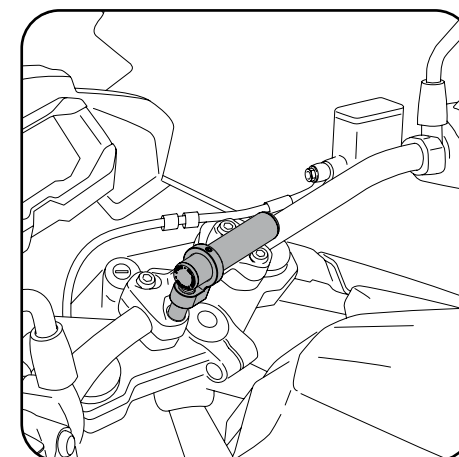
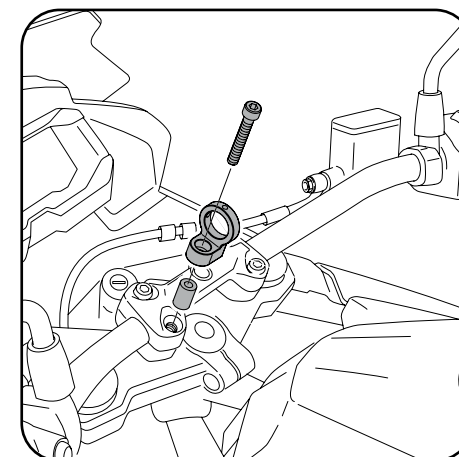

REF. 3570P

RISERS HANDLEBAR SUPPORT

MODEL	REF.	P
UNIVERSAL		
HANDLEBAR BAR SUPPORT	3570P	(*)

Smartphone mount of superior quality, with machined parts in billet aluminium and anodized in silver color. Diameter of the tube is 20mm and 80mm in length which allows the attachment of several products such as GPS, cel phone, etc. It attaches easily and quickly. It is offered with screws in different lengths to adapt it to any motorcycle.

It requires that you buy the 3534N support. Compatible with the mobile phone holder Ref.3836N and the Puig Motoplastic quick-fix covers Ref.3530N and 3531N.

Available for a wide range of models, consult adjustability to the motorcycle model in the web.

■ P Silver

(*) Check price with your distributor.
IMPORTANT: Indicate code color after part#. Example 0973A.



MOBILE SUPPORTS

HI-TECH PARTS | TECHNICAL SECTION



* Check availability for motorcycle models at www.puig.tv typing in the searching window.

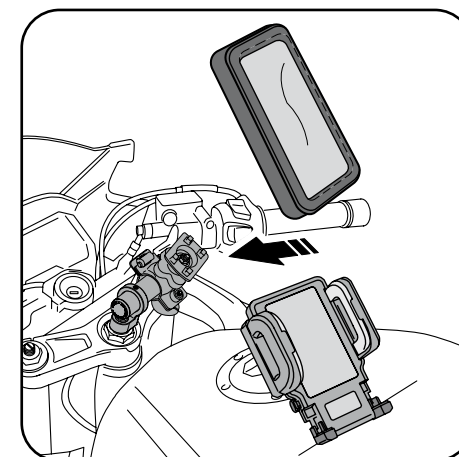
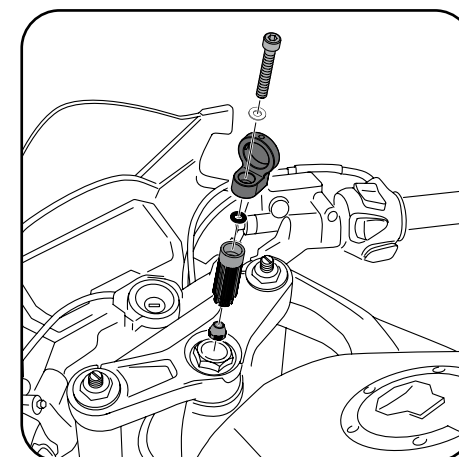
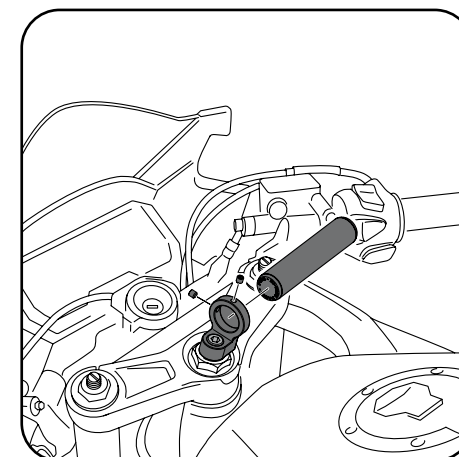

REF. 3756N



REF. 3756P



SUPPORT TO CENTRAL HOLE YOKE

MODEL	REF.	N	P
UNIVERSAL			
SUPPORT TO CENTRAL HOLE YOKE	3756N		(*)

Universal support for Sport motorcycles. It is fixed in the center of the yoke axle. Allows you to adjust the inclination and lateral movement. It consists of a machined aluminum body in silver or black, with a bar of the same color and a plastic support with an adjustable hemisphere that allows a quick adjustment without tools.

It can be mounted on any motorcycle that has a hole in the yoke axle (or a plug) with dimensions between Ø13 and Ø18, where the stamping pin will pass. Easy to assemble.

Compatible with the mobile phone holder Ref.3836N and the Puig Motoplasic quick-fix covers Ref.3530N and 3531N. Check the compatibility of the motorcycle at Puig Motoplasic website.

Available for a wide range of models, consult adjustability to the motorcycle model in the web.

■ P Silver

■ N Black

(*) Check price with your distributor.

IMPORTANT: Indicate code color after part#. Example 0973A.

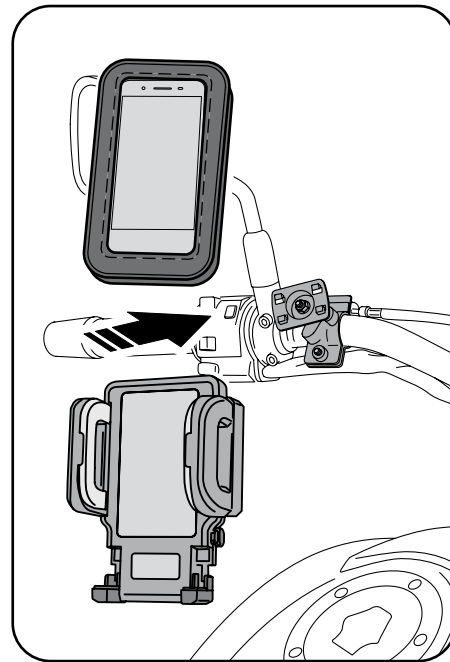

This element allows you to directly adjust the support for the Smartphone to the handlebar of the motorcycle. It is made out of two halves that adjust to each other with the handlebar in between, while they adjusted through a thumbscrew. We also offer different thickness rubber spacers, so that it ends up perfectly adjusted to the motorcycle.

Compatible with the mobile phone holder Ref.3836N and the Puig Motoplastic quick-fix covers Ref.3530N and 3531N.

This part is good for any handlebar that has a diameter of Ø20 until Ø25 mm and just like any of our supports, it is compatible with our cel phone covers.

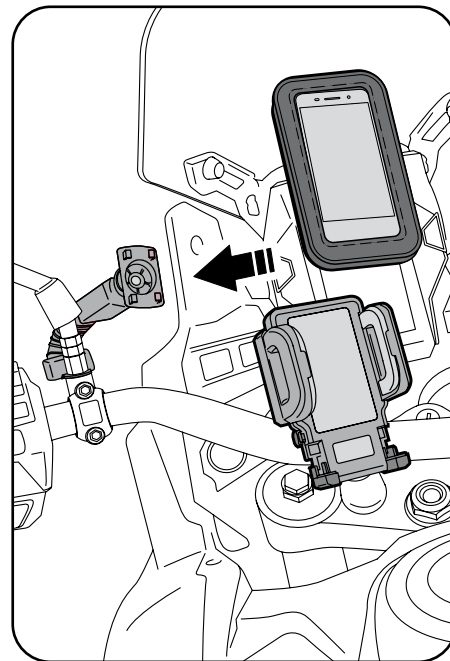

Support for the rearview mirror base, it is an universal support with complete mobility, 360° and also allows 100% adjustability to guarantee the best view during the ride, so the rider doesn't loose focus of the road.

Compatible with the mobile phone holder Ref.3836N and the Puig Motoplastic quick-fix covers Ref.3530N and 3531N.

The support is made of a metal base and a semi-rigid arm that guarantees a perfect attachment to the base of the rearview mirror. This support is good for all those motorcycle models that carry the rearview mirrors over the handlebars and are also compatible with Puig's covers.

N Black

* Check availability for motorcycle models at www.puig.tv typing in the searching window.



REF. 3534N

HANDLEBAR

MODEL	REF.	N
UNIVERSAL		
HANDLEBAR BRACKET	3534N	(*)

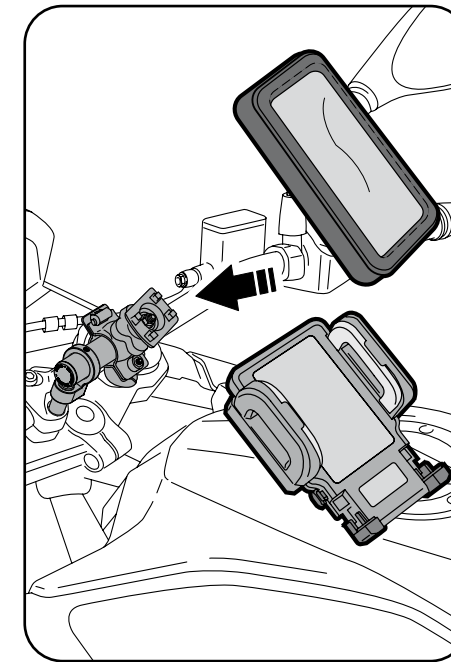

A support of easy and quick application, where the plastic cover hugs the rearview mirror rod and it is attached by a thumbscrew. It is offered with different rubber spacers, of different thickness, to adapt it to the different motorcycles needs

Compatible with the mobile phone holder Ref.3836N and the Puig Motoplastic quick-fix covers Ref.3530N and 3531N.

This support is good for mounting over any rearview mirror with a cilindrical rod of Ø9 until Ø25 and just like the last one it is compatible with our covers.



REF. 3533N

REARVIEW MIRROR ROD

MODEL	REF.	N
UNIVERSAL		
REAR VIEW MIRROR SUPPORT	3533N	(*)



REF. 3532N

REARVIEW MIRROR BASE

MODEL	REF.	N
UNIVERSAL		
REARVIEW BASE SUPPORT	3532N	(*)

N Black

(*) Check price with your distributor.

IMPORTANT: Indicate code color after part#. Example 0973A.

(*) Check price with your distributor.

IMPORTANT: Indicate code color after part#. Example 0973A.

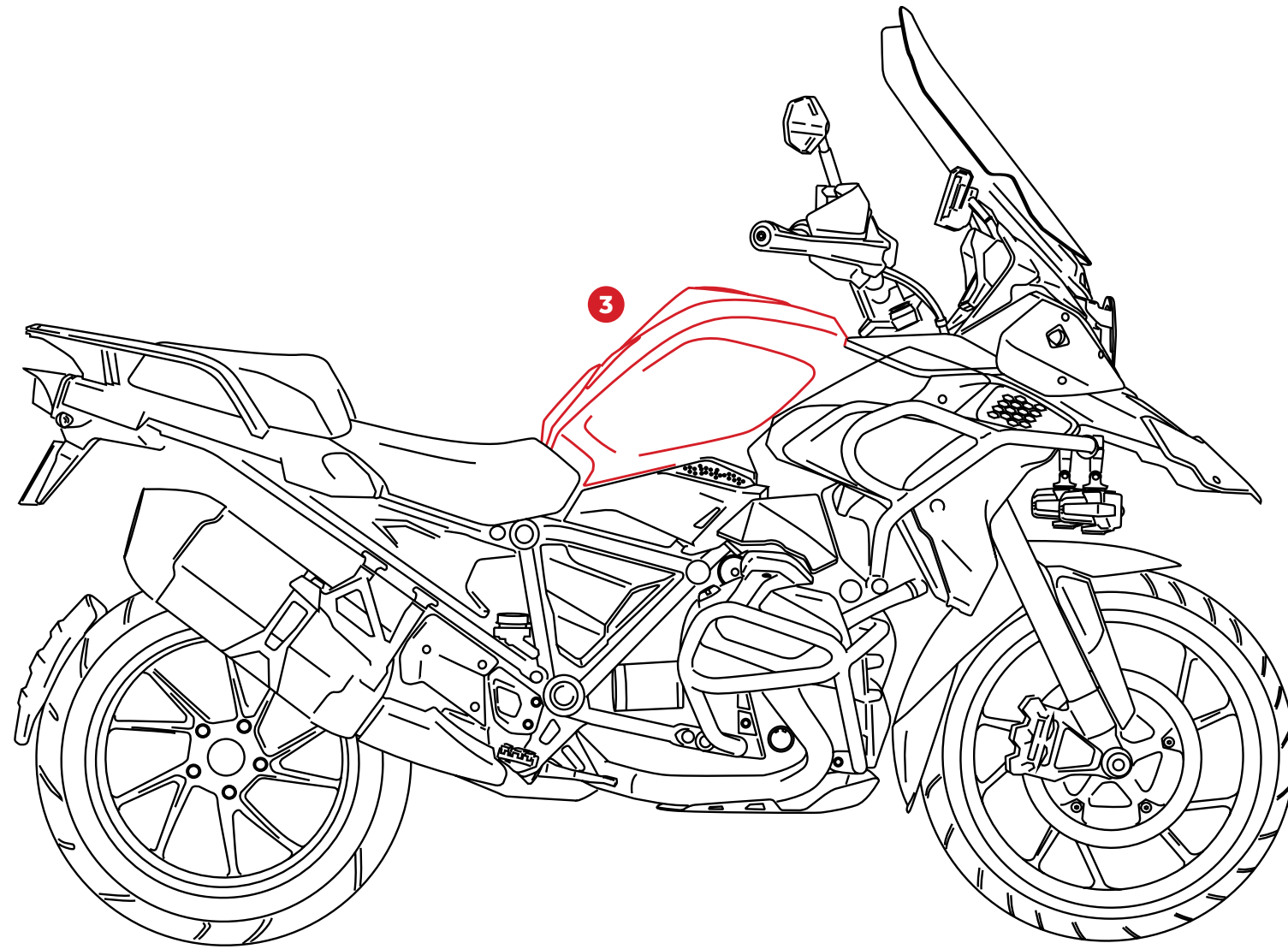

GAS TANK AREA

ADHESIVE FOAM SEAT	385
ADHESIVE NAKED YOKE & TANK PADS	351
ADHESIVE RADIKAL YOKE & TANK PADS	355
ADHESIVE TANK PADS SET	363
ADHESIVE X-TREME YOKE & TANK PADS	359
BIKE / F-YOU / MUGELLO TANK PADS	381
BUMPS-SHEET	385
DREI TANK PADS	368
FUTURE / VIOLENT TANK PADS	376
HANDHOLDS	345
JOKER / CLOWN TANK PADS	379
MARC MÁRQUEZ TANK PADS	349
MINI / ARROW TANK PADS	383
MOON / SCREAM TANK PADS	378
PERFORMANCE 2 TANK PADS	370
PERFORMANCE TANK PADS	369
PROTECTOR SCRATCH SAVER	387
SHEETS	385
SKULL / SKULL I / COLOURY TANK PADS	382
SKULL PARTY / SKULL PARTY BLACK & WHITE / ROCK & ROLL TANK PADS	380
SPIRIT II / ONE TANK PADS	377
SPIRIT TANK PADS	374
TANK SIDE PROTECTORS ANTI-SLIP	365
TIRE / LEATHER / SOFT TANK PADS	371
WAY / SUN TANK PADS	384
WINGS TANK PADS	372

HANDHOLDS

HI-TECH PARTS | TECHNICAL SECTION



2022		For the new 2022 motorcycle models check www.puig.tv			
MODEL	YEAR	Nº SCREWS	REF.	N	
APRILIA					
RSV4	09' - 12'	WITHOUT SCREWS	3615N	(*)	
RSV4 FACTORY	13' - 14'	WITHOUT SCREWS	3615N	(*)	
RSV4 R	13' - 14'	WITHOUT SCREWS	3615N	(*)	
RSV4 RF/RR	15' - 20'	WITHOUT SCREWS	9035N	(*)	
RS 660	21'	6	5148N	(*)	
SHIVER 750	07' - 20'	WITHOUT SCREWS	5148N	(*)	
SHIVER 900	17' - 21'	WITHOUT SCREWS	5148N	(*)	
TUONO V4R	11' - 14'	WITHOUT SCREWS	9035N	(*)	
TUONO V4 1100 RR	15' - 21'	WITHOUT SCREWS	9035N	(*)	
TUONO V4 1100 FACTORY	15' - 20'	WITHOUT SCREWS	9035N	(*)	
BMW					
G310R	16' - 20'	6	5148N	(*)	
R 1150R	01' - 06'	6	9037N	(*)	
R 1200R	05' - 06'	6	9037N	(*)	
R1250R	19' - 21'	6	9037N	(*)	
R1250RS	19' - 21'	6	9037N	(*)	
S1000 R	14' - 20'	WITHOUT SCREWS	6741N	(*)	
S1000RR	09' - 21'	WITHOUT SCREWS	6741N	(*)	
DUCATI					
1199 PANIGALE	12' - 14'	WITHOUT SCREWS	9035N	(*)	
1299 PANIGALE/S	15' - 17'	WITHOUT SCREWS	9035N	(*)	
959 PANIGALE	16' - 20'	WITHOUT SCREWS	9035N	(*)	

N Black

2022		For the new 2022 motorcycle models check www.puig.tv			
MODEL	YEAR	Nº SCREWS	REF.	N	
959 PANIGALE CORSE	18' - 20'	WITHOUT SCREWS	9035N	(*)	
PANIGALE 1100 V4	18' - 21'	WITHOUT SCREWS	9035N	(*)	
PANIGALE 1100 V4S	18' - 21'	WITHOUT SCREWS	9035N	(*)	
PANIGALE 1100 V4R	18' - 21'	WITHOUT SCREWS	9035N	(*)	
SUPERSPORT 939/S	17' - 20'	5	5149N	(*)	
STREETFIGHTER V4	20' - 21'	WITHOUT SCREWS	9035N	(*)	
HONDA					
CB500F	20' - 21'	5	9036N	(*)	
CBR600F	91' - 07'	7	4614N	(*)	
CBR500R	16' - 21'	5	9036N	(*)	
CBR600RR	03' - 13'	7	4614N	(*)	
CBR650R	19' - 20'	5	9036N	(*)	
CBR900RR FIRE BLADE	92' - 03'	7	4614N	(*)	
CBR1000RR FIRE BLADE	04' - 14'	7	4614N	(*)	
CBR1000RR FIRE BLADE	15' - 21'	5	9036N	(*)	
CBR1100XX BLACKBIRD	97' - 07'	7	4614N	(*)	
NT650 REVERE	88' - 98'	7	4614N	(*)	
VFR800F	98' - 01'	7	4614N	(*)	
VFR800F	15' - 18'	5	9036N	(*)	
VFR800	02' - 13'	7	4614N	(*)	
VFR1200F	10' - 16'	7	4614N	(*)	
VTR1000F FIRE STORM	97' - 07'	7	4614N	(*)	
VTR1000 SP-1	00' - 02'	7	4614N	(*)	
VTR1000 SP-2	02' - 05'	7	4614N	(*)	
KAWASAKI					
ER-6F	06' - 16'	5	4613N	(*)	
ER-6N	05' - 16'	5	4613N	(*)	
GT1400	07' - 16'	5	4613N	(*)	
NINJA 250R	08' - 12'	6	6742N	(*)	
NINJA 300	13' - 15'	6	6742N	(*)	
NINJA 400	18' - 21'	8	3761N	(*)	
NINJA 650	17' - 21'	8	3761N	(*)	

MADE IN LIGHT ALUMINIUM.

(*) Check price with your distributor.

IMPORTANT: Indicate code color after part#. Example 0973A.

2022 For the new 2022 motorcycle models check www.puig.tv					
MODEL	YEAR	Nº SCREWS	REF.	N	
NINJA H2 SX	20' - 21'	8	3761N	(*)	
Z250SL	15' - 17'	8	6742N	(*)	
Z400	19' - 21'	8	3761N	(*)	
Z650	17' - 21'	8	3761N	(*)	
Z750	07' - 12'	8	4613N	(*)	
Z750R	11' - 12'	8	4613N	(*)	
Z800	13' - 16'	8	4613N	(*)	
Z900	17' - 21'	8	3761N	(*)	
Z1000	03' - 13'	8	4613N	(*)	
Z1000	14' - 21'	8	9700N	(*)	
Z1000SX	17' - 19'	8	4613N	(*)	
ZX-6R	00' - 16'	8	4613N	(*)	
ZX-6R	18' - 21'	8	3761N	(*)	
ZX-6R 636	13' - 16'	5	4613N	(*)	
ZX-10R	04' - 21'	5	4613N	(*)	
ZZR1400	06' - 21'	5	4613N	(*)	
KTM					
1290 SUPERDUKE R	14' - 21'	6	9037N	(*)	
MV AGUSTA					
F3 675	12' - 21'	6	9038N	(*)	
F4	10' - 20'	5	5150N	(*)	
F4 750	99' - 04'	5	5150N	(*)	
BRUTALE	05' - 09'	5	5150N	(*)	
BRUTALE 675	12' - 16'	6	9038N	(*)	
BRUTALE 800/RR	13' - 16'	6	9038N	(*)	
BRUTALE 1090 RR	13' - 18'	WITHOUT SCREWS	3616N	(*)	
DRAGSTER 800/RR	14' - 16'	6	9038N	(*)	
RIVALE 800	13' - 16'	6	9038N	(*)	
SUZUKI					
BANDIT 1250F	17'	5	4612N	(*)	
GSF650 BANDIT	05' - 17'	5	4612N	(*)	
GSF650S BANDIT	05' - 14'	5	4612N	(*)	
GSF650S BANDIT	07' - 14'	7	6842N	(*)	
GSR600	05' - 13'	5	4612N	(*)	
GSR750	11' - 16'	5	4612N	(*)	
GSX650	05' - 17'	5	4612N	(*)	

2022 For the new 2022 motorcycle models check www.puig.tv					
MODEL	YEAR	Nº SCREWS	REF.	N	
GSX-R250	17' - 21'	5	4612N	(*)	
GSX-R300	17' - 20'	5	4612N	(*)	
GSX-R150	18' - 20'	5	4611N	(*)	
GSX-R600	04' - 17'	5	4611N	(*)	
GSX-R750	93' - 03'	7	6842N	(*)	
GSX-R750	04' - 17'	5	4611N	(*)	
GSX-R1000	03' - 04'	5	4612N	(*)	
GSX-R1000	05' - 18'	5	4611N	(*)	
GSX-R1000	19' - 20'	5	4612N	(*)	
GSX-R1300 HAYABUSA	99' - 07'	7	6842N	(*)	
GSX-R1300 HAYABUSA	08' - 15'	5	4612N	(*)	
GSX-R600	98' - 03'	7	6842N	(*)	
GSX-S750	17' - 21'	5	4612N	(*)	
GSX-S1000	15' - 21'	5	4612N	(*)	
GSX-S1000F	15' - 21'	5	4612N	(*)	
GSX1250F	17'	5	4612N	(*)	
INAZUMA	13' - 17'	5	4612N	(*)	
KATANA	19' - 21'	5	4612N	(*)	
SV1000	00' - 03'	7	6842N	(*)	
SV650	00' - 03'	7	6842N	(*)	
SFV650 GLADIUS	09' - 15'	5	4612N	(*)	
SV650	04' - 08'	5	4611N	(*)	
SV650	16' - 17'	5	4612N	(*)	
SV650X	18' - 21'	5	4612N	(*)	
SV1000	04'-07'	5	4611N	(*)	
TRIUMPH					
DAYTONA 675/R	06' - 19'	6	5148N	(*)	
DAYTONA 955i	02' - 06'	6	5148N	(*)	
SPEED FOUR 600	00' - 06'	6	5148N	(*)	
SPEED TRIPLE	08' - 20'	6	5148N	(*)	
SPRINT ST	08' - 15'	6	5148N	(*)	
STREET TRIPLE/R	08' - 19'	6	5148N	(*)	
STREET TRIPLE R/S	20' - 21'	6	5148N	(*)	
STREET TRIPLE RS	18' - 21'	6	5148N	(*)	
YAMAHA					
FAZER8	13' - 16'	5	4616N	(*)	
FZ1/ FZ1 FAZER	06' - 15'	5	4616N	(*)	

2022 For the new 2022 motorcycle models check www.puig.tv					
MODEL	YEAR	Nº SCREWS	REF.	N	
FZ6	04' - 06'	5	4616N	(*)	
FZ6 FAZER	07' - 08'	5	4616N	(*)	
FZ8	10' - 16'	5	4616N	(*)	
FZ8 FAZER	10' - 12'	5	4616N	(*)	
MT-01	05' - 13'	5	4616N	(*)	
MT-03	06' - 14'	5	4616N	(*)	
MT-09	13' - 20'	5	4616N	(*)	
MT-09 SP	18' - 20'	5	4616N	(*)	
MT-10	16' - 21'	3	9039N	(*)	
NIKEN	18' - 21'	5	4616N	(*)	
XJ6	09' - 16'	5	4616N	(*)	
XJ6 DIVERSION	09' - 16'	5	4616N	(*)	
XJ6 DIVERSION F	10' - 16'	5	4616N	(*)	
YZF-R1	02' - 14'	5	4615N	(*)	
YZF-R1	15' - 21'	3	9040N	(*)	
YZF-R3	18'	5	4615N	(*)	
YZF-R3	19' - 21'	3	9040N	(*)	
YZF-R6	04' - 16'	5	4615N	(*)	
YZF-R6	17' - 20'	5	9040N	(*)	

 N Black

MADE IN LIGHT ALUMINIUM.
(*) Check price with your distributor.
IMPORTANT: Indicate code color after part#. Example 0973A.

 N Black

MADE IN LIGHT ALUMINIUM.
(*) Check price with your distributor.
IMPORTANT: Indicate code color after part#. Example 0973A.



MM93
MARC MARQUEZ
OFFICIAL PRODUCT

MARC MÁRQUEZ TANK PADS

HI-TECH PARTS | TECHNICAL SECTION

NEW!



93

MODEL	REF.	C	W
93 CARBON LOOK	20682C	(*)	
93 TRANSPARENT	20682W		(*)

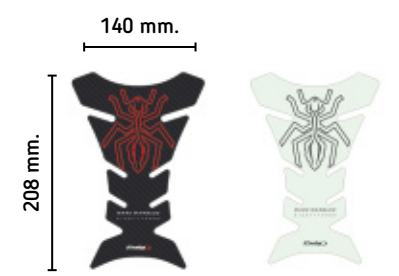

BIG ANT

MODEL	REF.	C	W
BIG ANT CARBON LOOK	20681C	(*)	
BIG ANT TRANSPARENT	20681W		(*)



MM93

MODEL	REF.	C	W
MM93 CARBON LOOK	20683C	(*)	
MM93 TRANSPARENT	20683W		(*)

 C Carbon look
 W Transparent

(*) Check price with your distributor.
IMPORTANT: Indicate code color after part#. Example 0973A.



ADHESIVE NAKED YOKE & TANK PADS

HI-TECH PARTS | TECHNICAL SECTION



TANKPAD NAKED

* Check availability for motorcycle models at www.puig.tv typing in the searching window.



TANK PAD

MODEL	REF.	U
UNIVERSAL	6291U	(*)



PLUG DEPOSIT PROTECTOR

MODEL	REF.	U
SPECIFIC MODELS (#)	CHECK OUR WEBSITE	(*)



YOKE PROTECTOR

MODEL	REF.	U
SPECIFIC MODELS	CHECK OUR WEBSITE	(*)

(#) DRAWINGS OF ALL FUEL CAP PROTECTORS AVAILABLE SEE PAGE 352.



NAKED FUEL CAP COVER

HI-TECH PARTS

2022

For the new 2022 motorcycle models check www.puig.tv

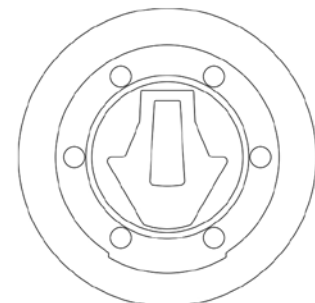

3698

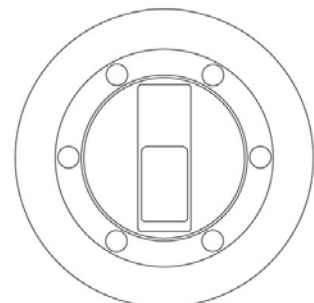

6293

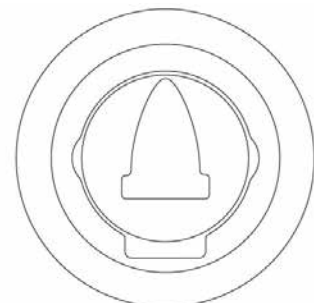

6295

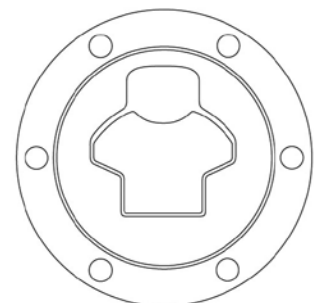

6297

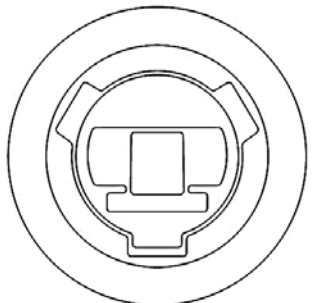

6299

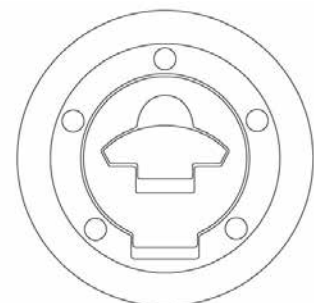

6303

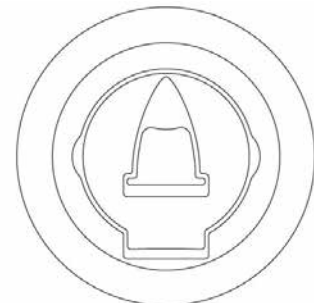

6305

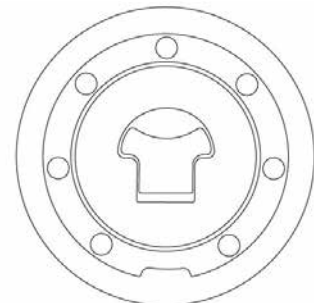

6307

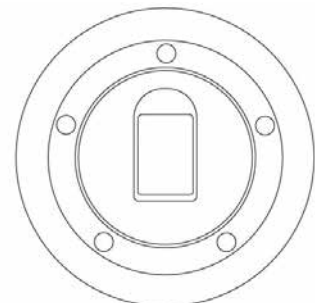

6309

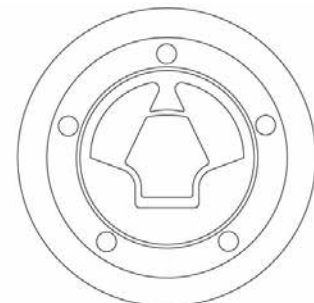

6311

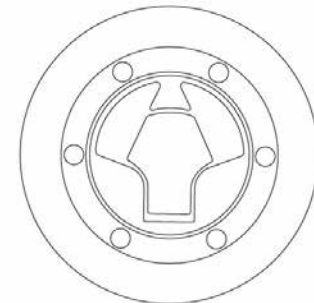

6313

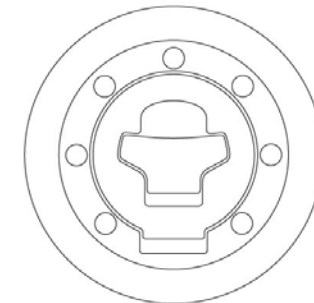

6315

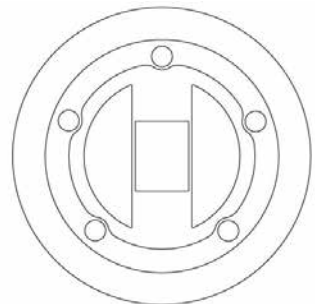

6317

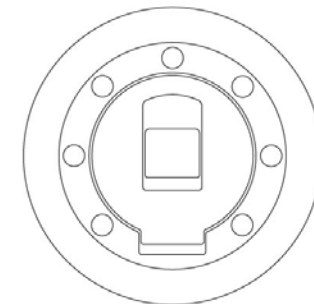

6321

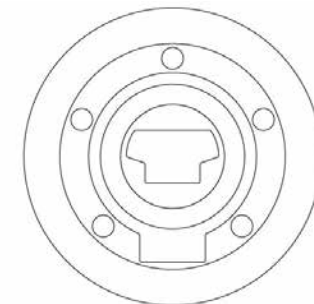

6323

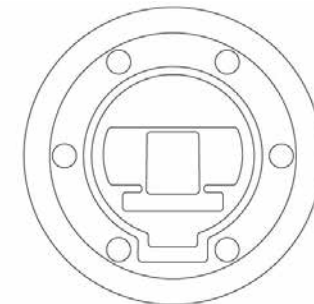

6824

2022

For the new 2022 motorcycle models check www.puig.tv

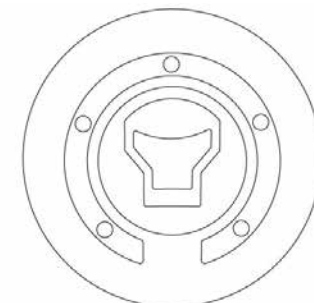

7571

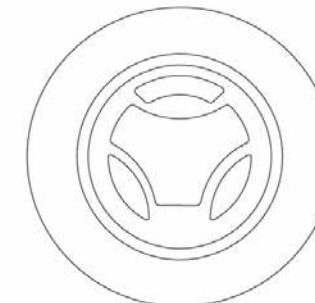

7583

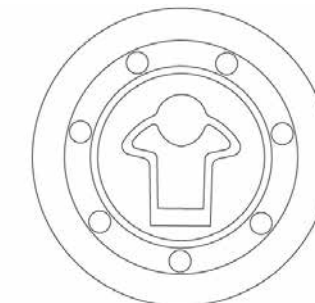

7610

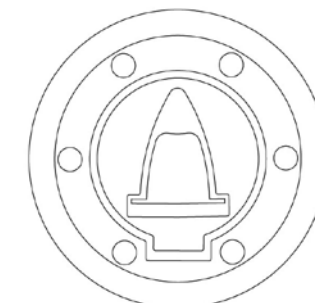

8172

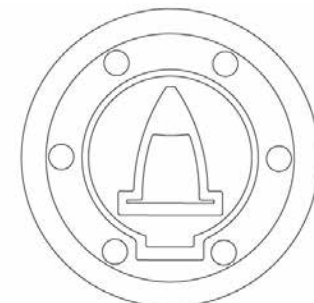

8236

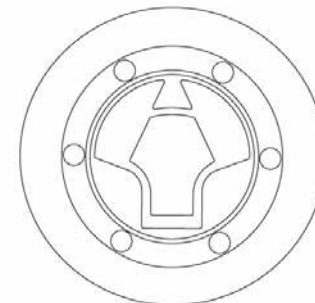

8242

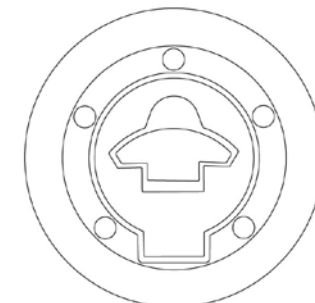

8254

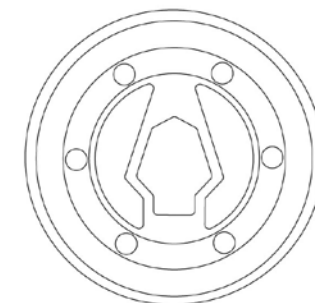

8968

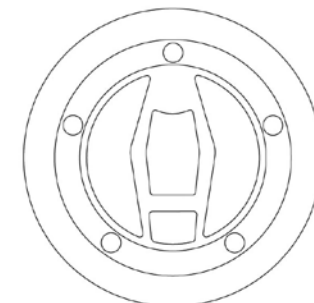

8976

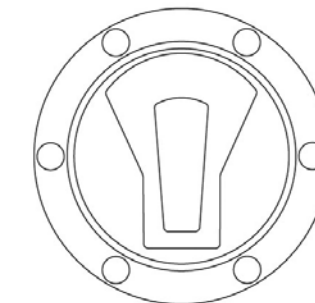

8978

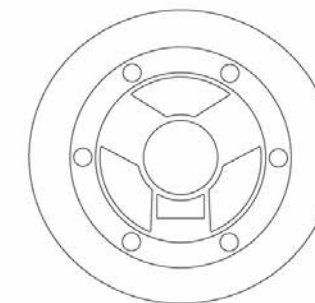

8980

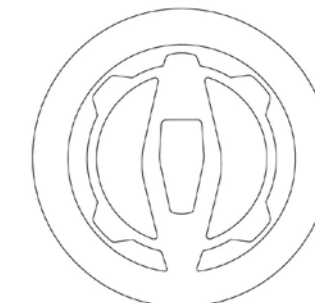

9361

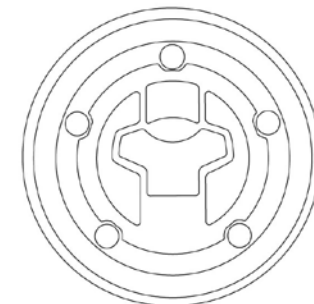

9428

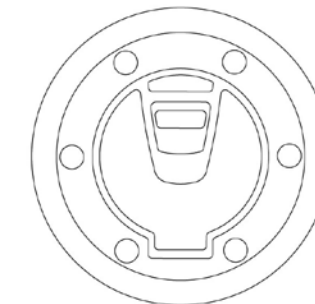

9446

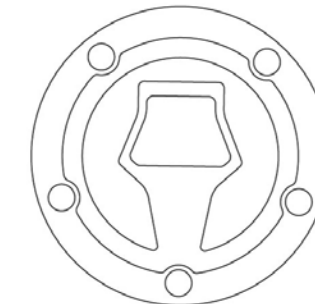

9608

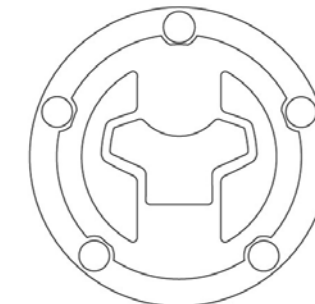

9964

IMPORTANT: We recommend verify the design of the cap with the above diagrams when ordering.

IMPORTANT: We recommend verify the design of the cap with the above diagrams when ordering.



ADHESIVE RADIKAL YOKE & TANK PADS

HI-TECH PARTS | TECHNICAL SECTION



TANKPAD RADIKAL

* Check availability for motorcycle models at www.puig.tv typing in the searching window.



TANK PAD

MODEL	REF.	A	R	U	V
UNIVERSAL	6292			*	



PLUG DEPOSIT PROTECTOR

MODEL	REF.	A	R	U	V
SPECIFIC MODELS (#)	CHECK OUR WEBSITE			*	

(#) DRAWINGS OF ALL FUEL CAP PROTECTORS AVAILABLE SEE PAGE 356.



YOKE PROTECTOR

MODEL	REF.	A	R	U	V
SPECIFIC MODELS	CHECK OUR WEBSITE			*	

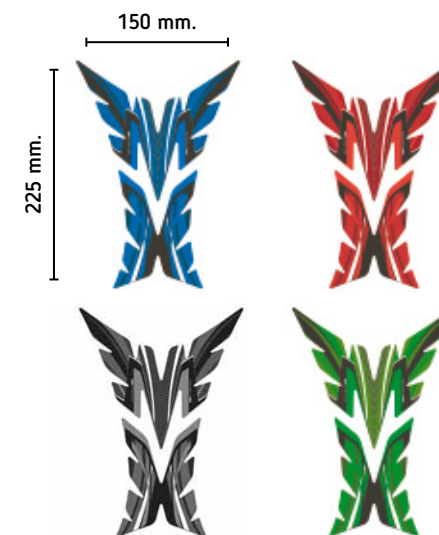

RADIKAL FUEL CAP COVER

HI-TECH PARTS

2022

For the new 2022 motorcycle models check www.puig.tv

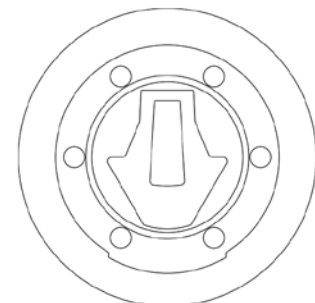

3696

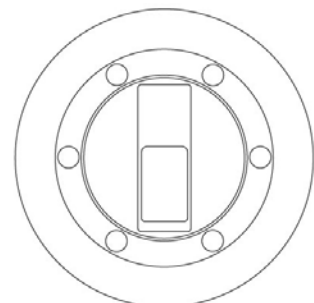

6294

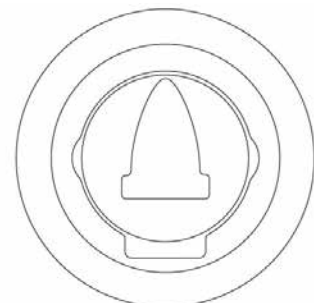

6296

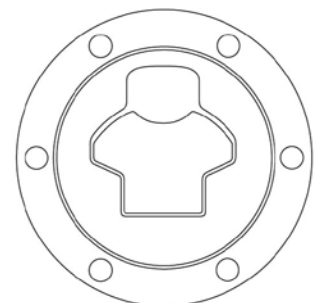

6298

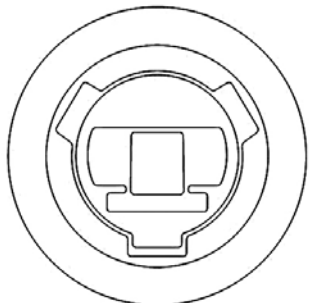

6300

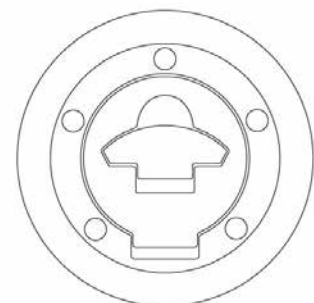

6304

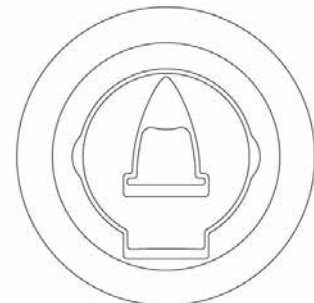

6306

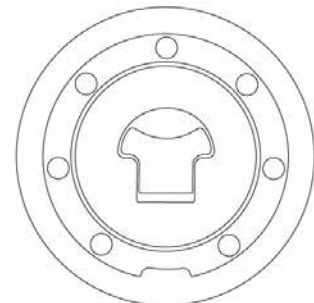

6308

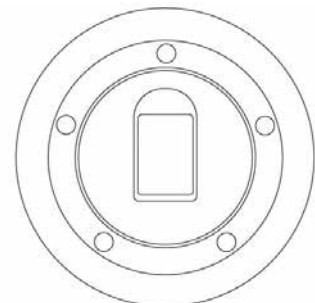

6310

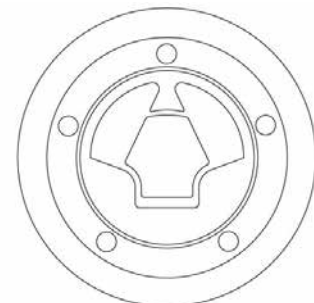

6312

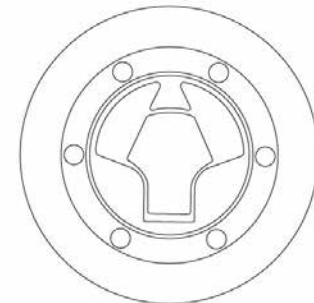

6314

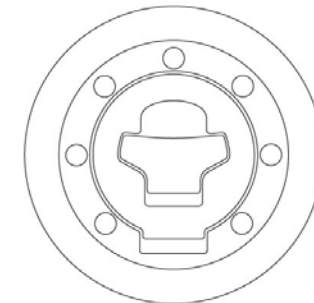

6316

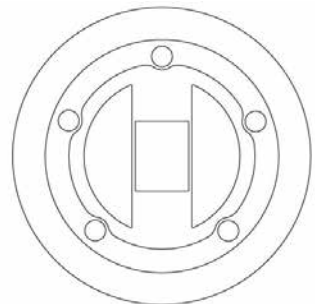

6318

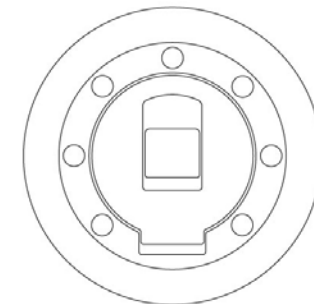

6322

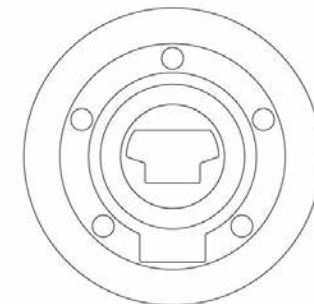

6324

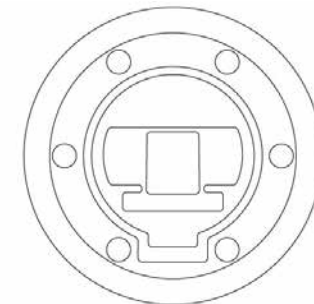

6825

2022

For the new 2022 motorcycle models check www.puig.tv

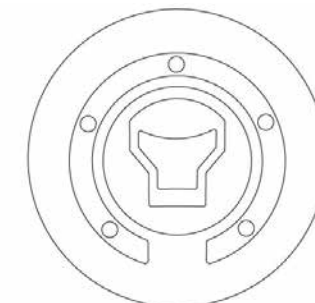

7572

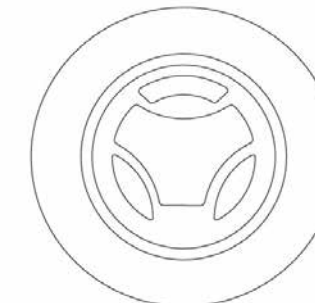

7584

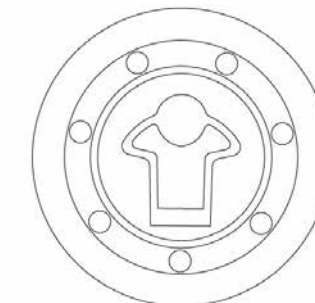

7611

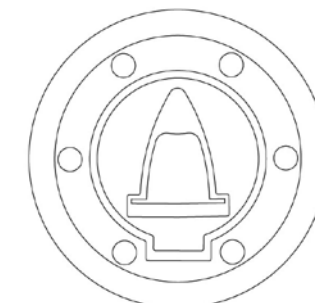

8174

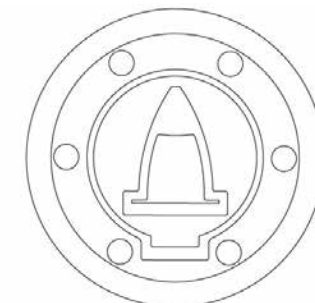

8263

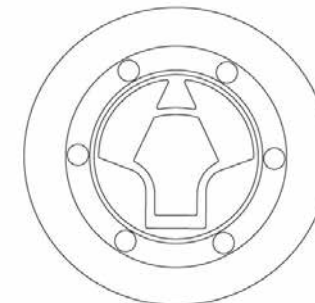

8269

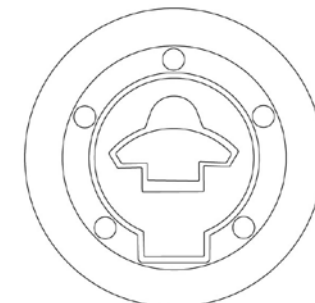

8281

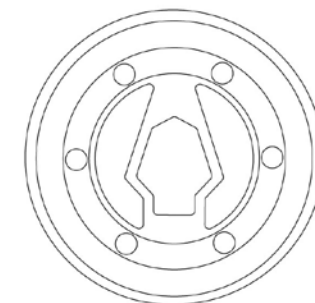

9041

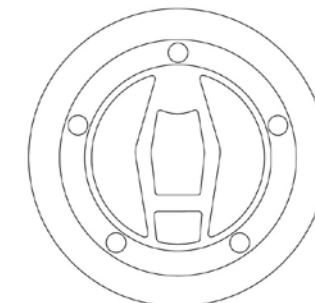

9049

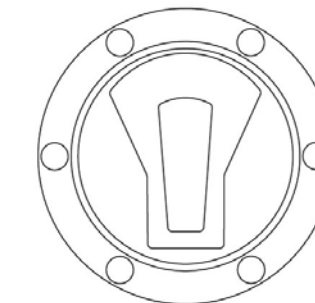

9051

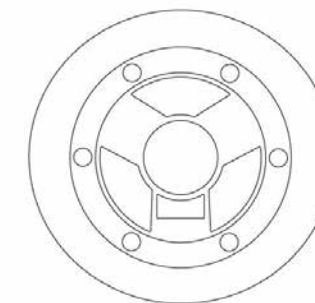

9053

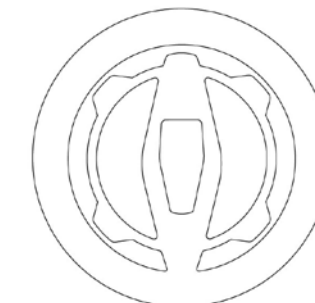

9362

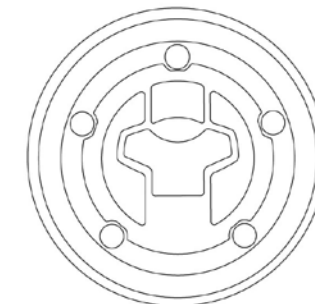

9429

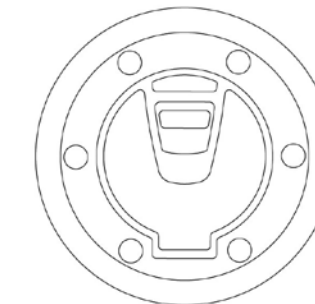

9447

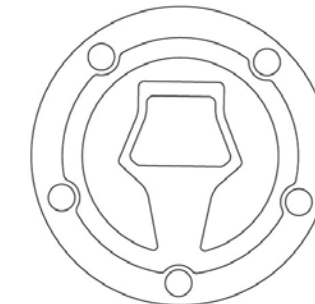

9609

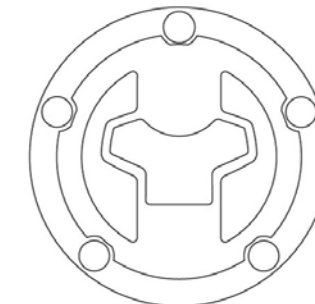

9965

IMPORTANT: We recommend verify the design of the cap with the above diagrams when ordering.

IMPORTANT: We recommend verify the design of the cap with the above diagrams when ordering.



ADHESIVE X-TREME YOKE & TANK PADS

HI-TECH PARTS | TECHNICAL SECTION



* Check availability for motorcycle models at www.puig.tv typing in the searching window.



TANK PAD

MODEL	REF.	C
UNIVERSAL	7597C	(*)



PLUG DEPOSIT PROTECTOR

MODEL	REF.	C
SPECIFIC MODELS (#)	CHECK OUR WEBSITE	(*)

(#) DRAWINGS OF ALL FUEL CAP PROTECTORS AVAILABLE SEE PAGE 360.



YOKE PROTECTOR

MODEL	REF.	C
SPECIFIC MODELS	CHECK OUR WEBSITE	(*)

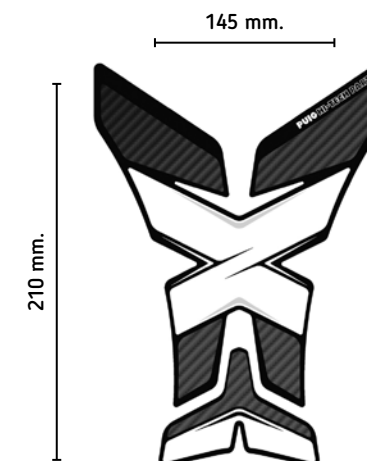

The central section of the tank pad is transparent.



X-TREME FUEL CAP COVER

HI-TECH PARTS

2022

For the new 2022 motorcycle models check www.puig.tv

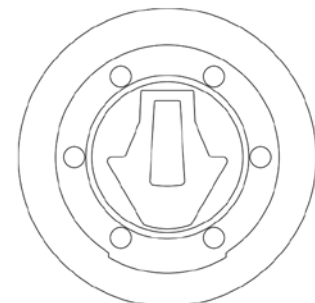

3697

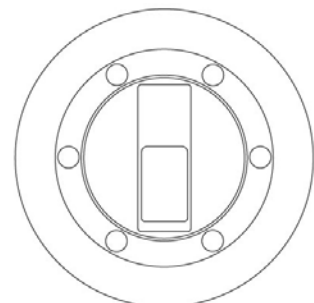

8375

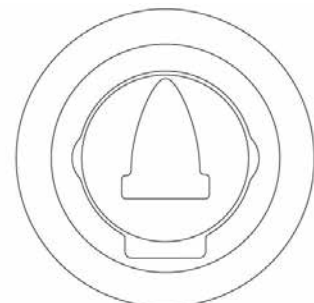

8376

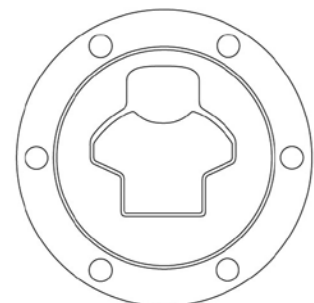

8382

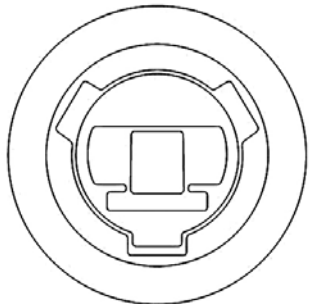

8383

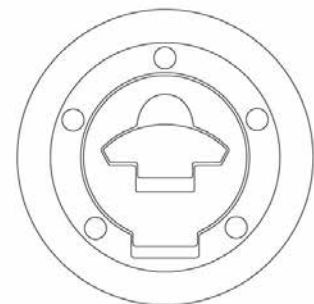

8385



8386



8390

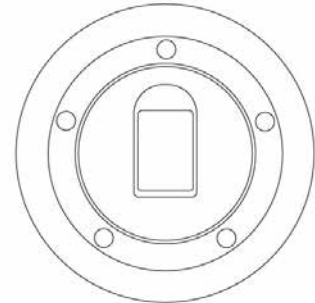

8401

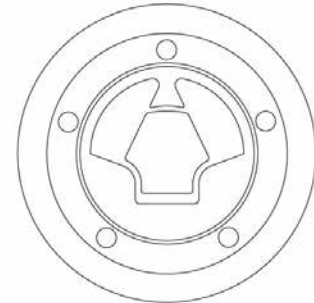

8402

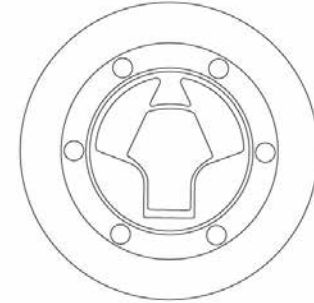

8394

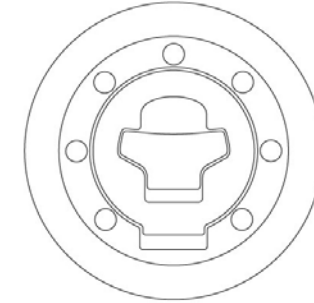

8409

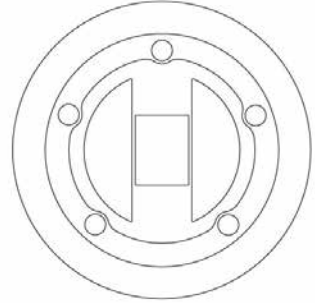

8410

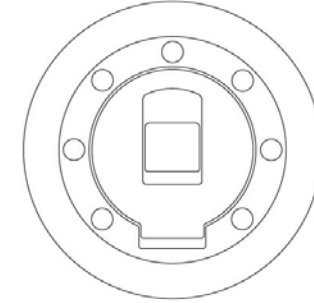

8415

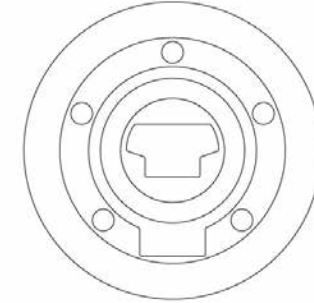

8416

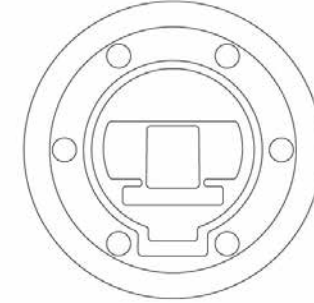

8379

2022

For the new 2022 motorcycle models check www.puig.tv

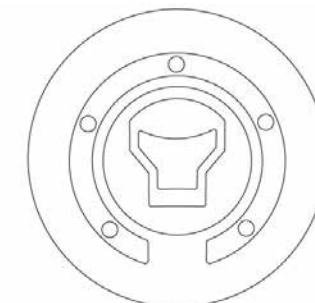

8391

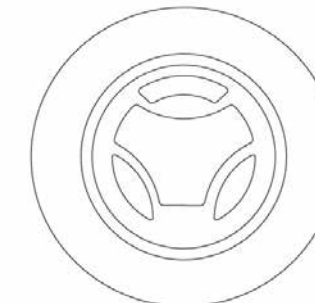

8414

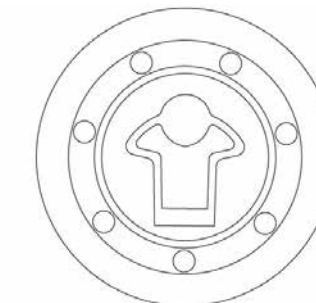

8405

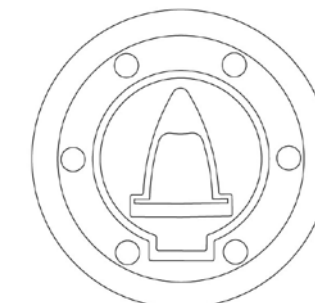

8175

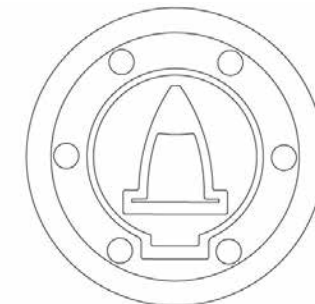

8384

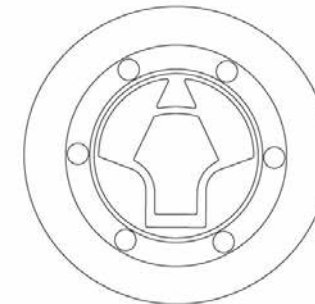

8399

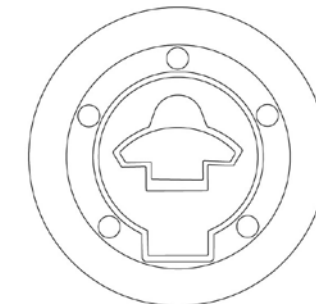

8413

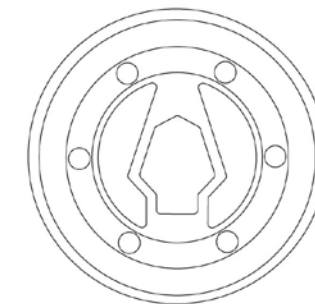

9057

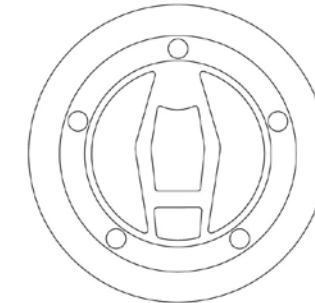

9065

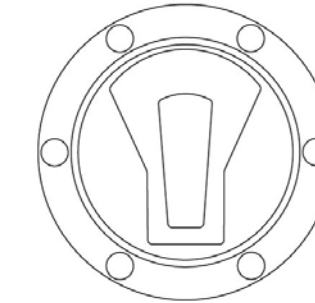

9067

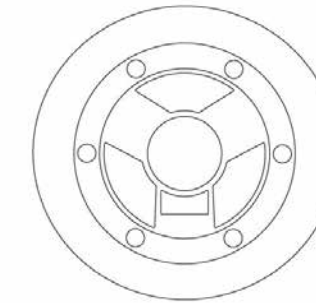

9069

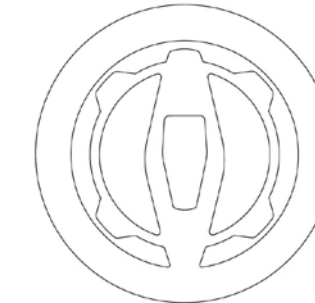

9363

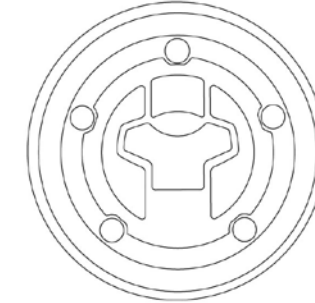

9430

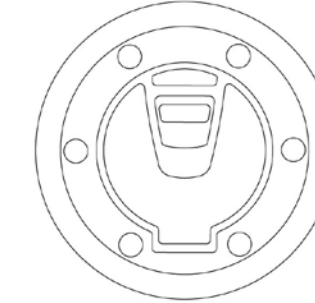

9448

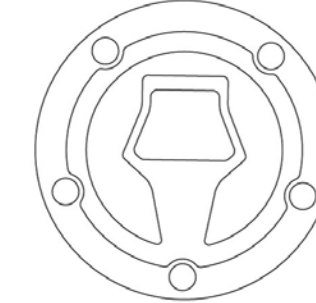

9610

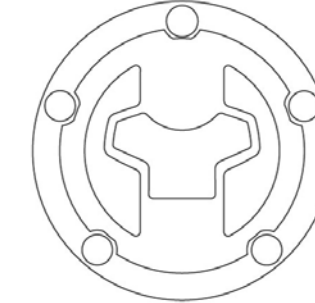

9966

IMPORTANT: We recommend verify the design of the cap with the above diagrams when ordering.

IMPORTANT: We recommend verify the design of the cap with the above diagrams when ordering.



ADHESIVE TANK PADS SET

HI-TECH PARTS | TECHNICAL SECTION



FORM DESIGNED SPECIFICALLY FOR EACH MODEL MOTORCYCLE

The kit consists of three elements: The frontal protection and the two lateral ones that improve grip in turns.

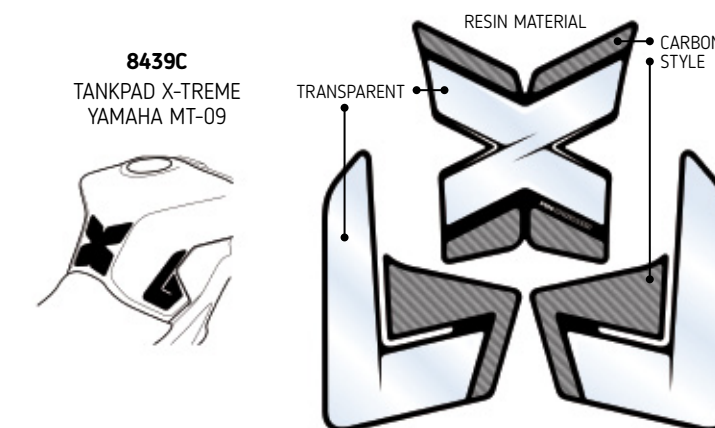

2022	For the new 2022 motorcycle models check www.puig.tv			
	MODEL	YEAR	REF.	C
BMW				
	F800R	09' - 20'	8433C	(*)
	F750GS	18' - 21'	3716C	(*)
	F850GS	18' - 21'	3717C	(*)
	F850GS ADVENTURE	19' - 21'	3718C	(*)
	S1000R	14' - 20'	9130C	(*)
	S1000XR	15' - 21'	3715C	(*)
	R1200GS	13 - 16'	8434C	(*)
	R1200GS	17' - 18'	9463C	(*)
	R1200GS EXCLUSIVE	17' - 18'	9463C	(*)
	R1200GS RALLYE	17' - 18'	9463C	(*)
	R1250GS	18' - 21'	3719C	(*)
	R1250GS HP	18' - 21'	3719C	(*)
	R1250GS ADVENTURE	18' - 20'	3720C	(*)
	R1250GS RALLYE	18' - 21'	3719C	(*)
	R NINE T	14' - 20'	9129C	(*)
	R NINE T SCRAMBLER	16' - 20'	9129C	(*)
	R NINE T PURE	17' - 20'	9129C	(*)
	R NINE T RACER	17' - 20'	9129C	(*)
	R NINE T URBAN G/S	17' - 20'	9129C	(*)
DUCATI				
	SCRAMBLER 1100	18' - 21'	9131C	(*)
	SCRAMBLER 1100 SPORT	18' - 21'	9131C	(*)
	SCRAMBLER 1100 SPECIAL	18' - 21'	9131C	(*)
	SCRAMBLER ICON/CLASSIC/FULL THROTTLE	15' - 21'	9131C	(*)
	SCRAMBLER SIXTY2	16' - 21'	9131C	(*)
	SCRAMBLER URBAN ENDURO	15' - 16'	9131C	(*)
	SCRAMBLER FLAT TRACK PRO	16'	9131C	(*)
	SCRAMBLER DESERT SLED	17' - 20'	9131C	(*)
	SCRAMBLER CAFE RACER	17' - 21'	9131C	(*)
HONDA				
	CMX 500 REBEL	17' - 21'	3721C	(*)

 C Carbon Look combined with transparent

2022	For the new 2022 motorcycle models check www.puig.tv			
	MODEL	YEAR	REF.	C
	CMX 500 REBEL S	20' - 21'	3721C	(*)
	CRF1000L AFRICA TWIN	16' - 19'	9303C	(*)
	CRF1000L AFRICA TWIN ADVENTURE SPORTS	18' - 19'	9303C	(*)
KAWASAKI				
	ER-6N	12' - 16'	9132C	(*)
	Z650	17' - 21'	9297C	(*)
	Z800/E	13' - 16'	8435C	(*)
	Z900	17' - 21'	9296C	(*)
	Z1000	14' - 19'	8436C	(*)
KTM				
	390 DUKE	17 - 21'	3722C	(*)
	790 DUKE	18' - 21'	3723C	(*)
	1290 SUPERDUKE R	14' - 21'	9298C	(*)
SUZUKI				
	GSR750	11' - 16'	8437C	(*)
	GSX-S750	17' - 21'	9295C	(*)
YAMAHA				
	MT-07	14' - 20'	8438C	(*)
	MT-07 TRACER	16' - 21'	9301C	(*)
	MT-07 TRACER GT	19' - 21'	9301C	(*)
	MT-09	13' - 20'	8439C	(*)
	MT-09 SP	18' - 20'	8439C	(*)
	MT-09 TRACER	15' - 20'	9302C	(*)
	MT-09 TRACER GT	18' - 20'	9302C	(*)
	MT-10	16' - 21'	9294C	(*)
	MT-10 SP	17' - 21'	9294C	(*)
	XSR700	16' - 21'	9300C	(*)
	XSR700 XTRIBUTE	19' - 21'	9300C	(*)
	XSR900	16' - 21'	9299C	(*)

(*) Check price with your distributor.
IMPORTANT: Indicate code color after part#. Example 0973A.



TANK SIDE PROTECTORS ANTI-SLIP

HI-TECH PARTS | TECHNICAL SECTION



EASY MOUNTING
PROCESS



ANTI-SCRATCH



IMPROVE
GRIP



SOFT RUBBER
FEEL

REF. 20060N



REF. 20060W



■ N Black

□ W Transparent

PARA SPECIFIC MODELS SEE PAGE 366.

TANK SIDE PROTECTORS ANTI-SLIP

HI-TECH PARTS | TECHNICAL SECTION

2022 For the new 2022 motorcycle models check www.puig.tv				
MODEL	YEAR	REF.	N	W
APRILIA				
RSV4	09' - 12'	20060	(*)	
RSV4 FACTORY	09' - 15'	20060	(*)	
RSV4 R	13' - 14'	20060	(*)	
RSV4 RF/RR	15' - 20'	20060	(*)	
RS 660	21'	20746	(*)	
TUONO 660	21'	20746	(*)	
TUONO 1100 RR	21'	20797	(*)	
TUONO V4 1100 FACTORY	15'-17'	20598	(*)	
TUONO V4R	11' - 14'	20060	(*)	
BENELLI				
TRK 502 X	17' - 21'	20749	(*)	
BMW				
F900 R	20'-21'	20599	(*)	
R1200 GS	04' - 12'	20061	(*)	
R1200 GS	13' - 18'	20062	(*)	
R1250 GS	18' - 21'	20600	(*)	
R1250 GS HP	18' - 21'	20600	(*)	
R1250 GS RALLYE	18' - 21'	20600	(*)	
R1200 GS RALLYE	17' - 18'	20062	(*)	
R1200 GS EXCLUSIVE	17' - 18'	20062	(*)	
R1200 GS ADVENTURE	06' - 13'	20061	(*)	
R1200GS ADVENTURE	14' - 18'	20063	(*)	
R1200 RS	14' - 19'	20064	(*)	
S1000 R	09' - 20'	20065	(*)	
S1000RR	09' - 18'	20065	(*)	
S1000RR	19' - 21'	20290	(*)	
S1000 XR	20' - 21'	20744	(*)	
DUCATI				
899 PANIGALE	14' - 15'	20066	(*)	
959 PANIGALE	16' - 20'	20066	(*)	
1199 PANIGALE	12' - 14'	20066	(*)	
1299 PANIGALE/S	15' - 17'	20066	(*)	
PANIGALE V2	21'	20743	(*)	
PANIGALE V2 BAYLISS	21'	20743	(*)	
PANIGALE 1100 V4	18' - 20'	20067	(*)	

2022 For the new 2022 motorcycle models check www.puig.tv				
MODEL	YEAR	REF.	N	W
PANIGALE 1100 V4 S	18' - 20'	20067	(*)	
MONSTER 797	17' - 20'	20068	(*)	
MONSTER 821	14' - 20'	20068	(*)	
MONSTER 1200/S	14' - 20'	20068	(*)	
MONSTER 1200 R	16' - 20'	20068	(*)	
MULTISTRADA 950	17' - 21'	20291	(*)	
MULTISTRADA 1200/ S	15' - 17'	20069	(*)	
MULTISTRADA 1200 ENDURO/PRO	16' - 21'	20070	(*)	
MULTISTRADA 1200 PIKES PEAK	16' - 17'	20069	(*)	
MULTISTRADA 1260/S/S D AIR	18' - 20'	20069	(*)	
MULTISTRADA 1260 PIKES PEAK	18' - 20'	20069	(*)	
MULTISTRADA 1260 ENDURO	18' - 20'	20070	(*)	
SCRAMBLER ICON/CLASSIC/FULL THROTTLE	15' - 21'	20071	(*)	
SCRAMBLER SIXTY2	16' - 21'	20071	(*)	
SCRAMBLER URBAN ENDURO	15' - 16'	20071	(*)	
SCRAMBLER FLAT TRACK PRO	16'	20071	(*)	
SCRAMBLER DESERT SLED	17' - 20'	20071	(*)	
SCRAMBLER CAFE RACER	17' - 21'	20071	(*)	
SCRAMBLER 1100	15' - 20'	20071	(*)	
SCRAMBLER 1100 SPORT	15' - 20'	20071	(*)	
SCRAMBLER 1100 SPECIAL	15' - 20'	20071	(*)	
HONDA				
CB650R NEO SPORTS CAFÉ	19'-21'	20601	(*)	
CBR600RR	13' - 16'	20072	(*)	
CBR650R	19' - 20'	20469	(*)	
CBR1000RR FIREBLADE/SP	12' - 16'	20073	(*)	
CBR1000RR FIREBLADE/SP/SP2	17' - 20'	20074	(*)	
CBR1000RR FIREBLADE/SP	21'	20074	(*)	
CRF1000L AFRICA TWIN	16' - 19'	20075	(*)	
CRF1000L AFRICA TWIN ADVENTURE SPORTS	18' - 19'	20487	(*)	
CRF1100L AFRICA TWIN	20' - 21'	20075	(*)	
CRF1100L AFRICA TWIN ADVENTURE SPORTS	20' - 21'	20487	(*)	
KAWASAKI				
NINJA 400	18' - 21'	20076	(*)	
NINJA 650	17' - 20'	20738	(*)	
VERSYS 1000	15' - 20'	20077	(*)	

2022 For the new 2022 motorcycle models check www.puig.tv				
MODEL	YEAR	REF.	N	W
Z900	17' - 21'	20078	(*)	
Z1000	18' - 20'	20079	(*)	
Z1000SX	11' - 19'	20079	(*)	
ZX-6R	09' - 16'	20080	(*)	
ZX-6R 636	09' - 16'	20080	(*)	
ZX-10R	11' - 20'	20081	(*)	
KTM				
690 DUKE	08' - 11'	20171	(*)	
1050 ADVENTURE	15' - 16'	20171	(*)	
1090 ADVENTURE /R	17' - 20'	20171	(*)	
1190 ADVENTURE /R	13' - 16'	20171	(*)	
1290 SUPER ADVENTURE	15' - 16'	20171	(*)	
1290 SUPER ADVENTURE R	17' - 20'	20171	(*)	
1290 SUPER ADVENTURE S	17' - 20'	20171	(*)	
1290 SUPER ADVENTURE T	17' - 20'	20171	(*)	
1290 SUPER ADVENTURE R/S	21'	20798	(*)	
1290 SUPER DUKE R	14' - 19'	20745	(*)	
SUZUKI				
DL1000 V-STROM	14' - 19'	20082	(*)	
DL1000XT V-STROM	17' - 19'	20082	(*)	
GSX-R600	11' - 16'	20083	(*)	
GSX-R750	11' - 16'	20083	(*)	
GSX-R1000/R	17' - 20'	20084	(*)	
GSX-S750	17' - 20'	20085	(*)	
GSX-S1000	15' - 20'	20086	(*)	
GSX-S1000F	16' - 21'	20086	(*)	
SV650	17'- 21'	20602	(*)	
TRIUMPH				
DAYTONA 675	13' - 17'	20087	(*)	
DAYTONA 675 R	13' - 17'	20087	(*)	
STREET TRIPLE	13' - 19'	20087	(*)	
STREET TRIPLE R	13' - 19'	20087	(*)	
STREET TRIPLE S/RS	17' - 19'	20087	(*)	
TIGER EXPLORER XC/XR/XRX/XRT/XCX/XCA	16' - 20'	20088	(*)	
TIGER 1200 ALPINE	21'	20088	(*)	
TIGER 1200 DESERT	21'	20088	(*)	

2022 For the new 2022 motorcycle models check www.puig.tv				
MODEL	YEAR	REF.	N	W
YAMAHA				
MT-07	14' - 17'	20750	(*)	
MT-07	18' - 20'	20089	(*)	
MT-07	21'	20739	(*)	
MT-07 TRACER	21'	20741	(*)	
MT-07 TRACER GT	21'	20741	(*)	
MT-09	13' - 20'	20090	(*)	
MT-09	21'	20740	(*)	
MT-09 SP	18' - 20'	20090	(*)	
MT-09 SP	21'	20740	(*)	
MT-09 TRACER	15' - 20'	20091	(*)	
MT-09 TRACER	21'	20799	(*)	
MT-09 TRACER GT	18' - 20'	20091	(*)	
MT-10	16' - 21'	20092	(*)	
MT-10 SP	17' - 21'	20092	(*)	
XT1200Z SUPER TÉNÉRÉ	12' - 21'	20093	(*)	
XT1200ZE SUPER TENERE	19' - 21'	20093	(*)	
YZF-R1	15' - 19'	20094	(*)	
YZF-R1M	17' - 19'	20094	(*)	
YZF-R1	20' - 21'	20604	(*)	
YZF-R1M	20' - 21'	20604	(*)	
YZF-R3	15'-18'	20603	(*)	
YZF-R3	19' - 21'	20292	(*)	
YZF-R6	08' - 16'	20095	(*)	
YZF-R6	17' - 20'	20096	(*)	
SPARES				
PRMOTER KIT FIJADOR		20220N	(*)	

N Black
W Transparent

(*) Check price with your distributor.
IMPORTANT: Indicate code color after part#. Example 0973A.

N Black
W Transparent



(*) Check price with your distributor.
IMPORTANT: Indicate code color after part#. Example 0973A.

DREI TANK PADS

HI-TECH PARTS



MODEL	REF.	C W
DREI CARBON LOOK	3075C	(*)
DREI TRANSPARENT	3075W	(*)

 C Carbon look
 W Transparent

(*) Check price with your distributor.
IMPORTANT: Indicate code color after part#. Example 0973A.

PERFORMANCE TANK PADS

HI-TECH PARTS

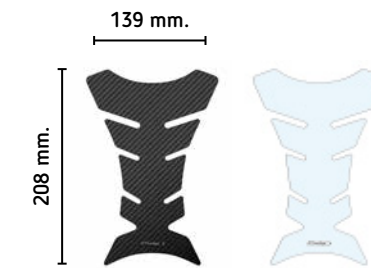

MODEL	REF.	C P U W
PERFORMANCE CARBON LOOK	4051C	(*)
PERFORMANCE TRANSPARENT	4051W	(*)
PERFORMANCE SILVER	4051P	(*)
PERFORMANCE GREY	4051U	(*)
50° ANNIVERSARY	7427C	(*)

 P Silver
 U Grey
 C Carbon look
 W Transparent

(*) Check price with your distributor.
IMPORTANT: Indicate code color after part#. Example 0973A.

PERFORMANCE 2 TANK PADS

HI-TECH PARTS

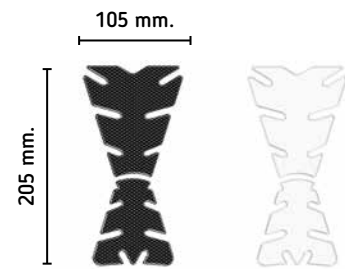
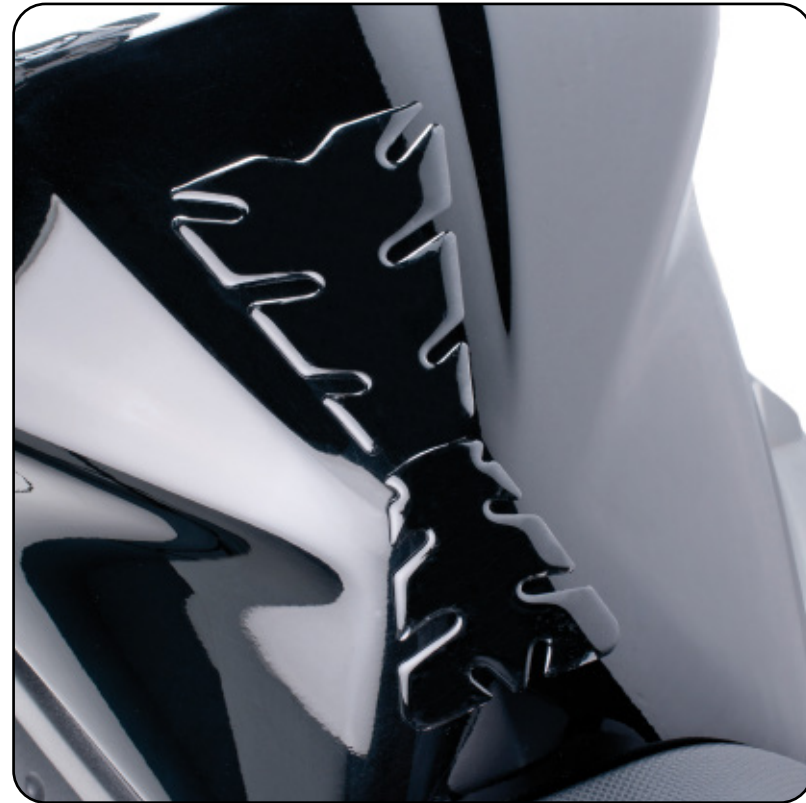

PERFORMANCE 2

MODEL	REF.	C W
PERFORMANCE 2 CARBON LOOK	5876C	(*)
PERFORMANCE 2 TRANSPARENT	5876W	(*)

C Carbon look
 W Transparent

(*) Check price with your distributor.
 IMPORTANT: Indicate code color after part#. Example 0973A.

TANK PADS

HI-TECH PARTS



EASY MOUNTING PROCESS



ANTI-SCRATCH



IMPROVE GRIP

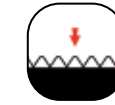

SOFT RUBBER FEEL



SOFT FEEL



SOFT FEEL

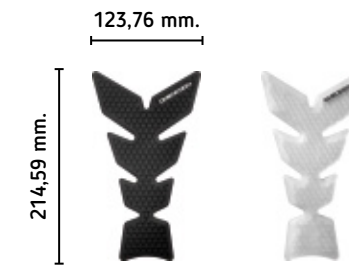

TIRE

MODEL	REF.	N W
TIRE BLACK	9939N	(*)
TIRE TRANSPARENT	9939W	(*)

B White
 U Grey

F Brown
 N Black

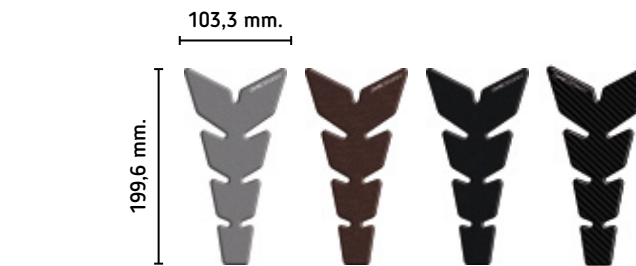

LEATHER

MODEL	REF.	U M N C
LEATHER GREY	9304U	(*)
LEATHER BROWN	9304F	(*)
LEATHER BLACK	9304N	(*)
LEATHER CARBON LOOK	9304C	(*)

C Carbon look
 W Transparent

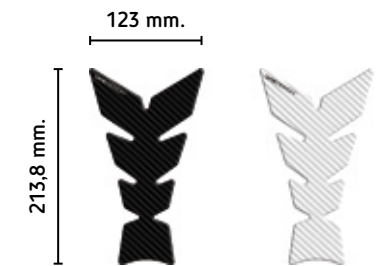

SOFT

MODEL	REF.	B C
SOFT CARBON LOOK	8432C	(*)
SOFT WHITE	8432B	(*)

Because of its width might not get properly fit on tanks with pronounced curves.

(*) Check price with your distributor.
 IMPORTANT: Indicate code color after part#. Example 0973A.

WINGS TANK PADS

HI-TECH PARTS



MODEL	REFERENCE	A R V N P
BMW (1)	4718N	(*)
DUCATI (2)	4719R	(*)
HONDA (3)	4785P	(*)
HONDA (4)	4785R	(*)
CBR (5)	4784A	(*)
CBR (6)	4784P	(*)
CBR (7)	4784R	(*)
KAWASAKI (8)	4720N	(*)
KAWASAKI (9)	4720V	(*)
NINJA (10)	4721V	(*)
NINJA (11)	4721R	(*)
SUZUKI (12)	4724A	(*)
YAMAHA (13)	4722A	(*)
YAMAHA (14)	4722R	(*)
YZF (15)	4723A	(*)
YZF (16)	4723R	(*)
YZF (17)	4723P	(*)

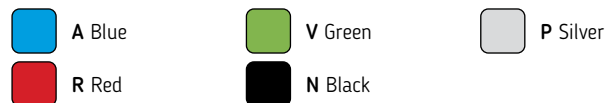

(*) Check price with your distributor.
 IMPORTANT: Indicate code color after part#. Example 0973A.

SPIRIT TANK PADS

HI-TECH PARTS



MODEL	REF.	N	P
APRILIA			
RSV1000	4727	(*)	
SHIVER	5111	(*)	
DUCATI			
1098	4728	(*)	
MONSTER	4726	(*)	
HONDA			
AFRICA TWIN	20484	(*)	
CBR	4223	(*)	
CBF	4725	(*)	
HORNET	4228	(*)	

N Black
 P Silver

MODEL	REF.	N	P
NC	9142	(*)	
REBEL	20483	(*)	
HYOSUNG			
GT650	4729	(*)	
KAWASAKI			
ER6F	5112	(*)	
ER6N	4327	(*)	
NINJA	4221	(*)	
VULCAN S	20485	(*)	
Z650	9306	(*)	
Z750	4328	(*)	
Z800	7484	(*)	
Z900	9307	(*)	
Z1000	4479	(*)	
KTM			
ADVENTURE	20482	(*)	
DUKE	20480	(*)	
SUZUKI			
BANDIT	4226	(*)	
GSR	4329	(*)	
GSX-R	4222	(*)	
SV	4225	(*)	
TRIUMPH			
DAYTONA	4730	(*)	
YAMAHA			
FZ	4227	(*)	
FAZER	4341	(*)	
R6	4220	(*)	
R1	4219	(*)	
XJ6	5110	(*)	
MT	9143	(*)	
XSR	9308	(*)	
TENERE	20481	(*)	
TENERE 700 RALLY EDITION	20481	(*)	
UNIVERSAL			
RACING	4224	(*)	

(*) Check price with your distributor.
 IMPORTANT: Indicate code color after part#. Example 0973A.



TANK PADS

HI-TECH PARTS



FUTURE

MODEL	REF.	A N R P V
APRILIA	5631N	(*)
BMW	6460P	(*)
DUCATI	5633R	(*)
HONDA	5634R	(*)
KAWASAKI (1)	5630P	(*)
KAWASAKI (2)	5630V	(*)
SUZUKI	5632A	(*)
YAMAHA	5635P	(*)

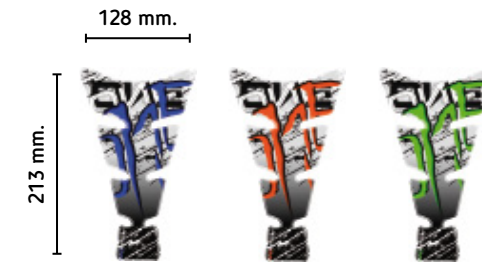

SPIRIT II

MODEL	REF.	A T W
SPIRIT II BLUE	9140A	(*)
SPIRIT II ORANGE	9140T	(*)
SPIRIT II GREEN	9140V	(*)



VIOLENT

MODEL	REF.	A N V C W R
VIOLENT BLUE	5519A	(*)
VIOLENT CARBON LOOK	5519C	(*)
VIOLENT BLACK	5519N	(*)
VIOLENT RED	5519R	(*)
VIOLENT GREEN	5519V	(*)
VIOLENT TRANSPARENT	5519W	(*)

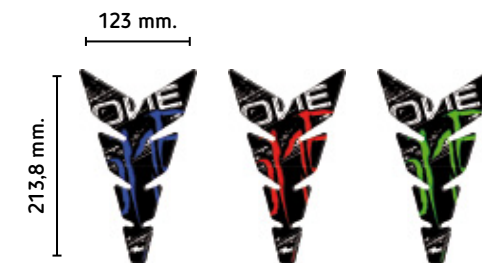

SOFT TOUCH

ONE

MODEL	REF.	A R V
ONE BLUE	9141A	(*)
ONE RED	9141R	(*)
ONE GREEN	9141V	(*)



(*) Check price with your distributor.
IMPORTANT: Indicate code color after part#. Example 0973A.

(*) Check price with your distributor.
IMPORTANT: Indicate code color after part#. Example 0973A.

TANK PADS

HI-TECH PARTS

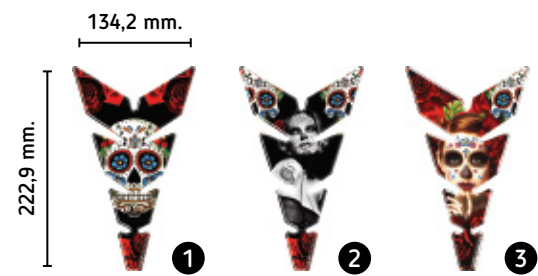

MOON

MODEL	REF.	R P T
MOON RED (1)	9139R	(*)
MOON SILVER (2)	9139P	(*)
MOON ORANGE (3)	9139T	(*)

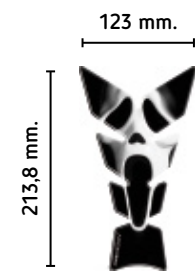

SCREAM

MODEL	REF.	N
SCREAM BLACK	9602N	(*)

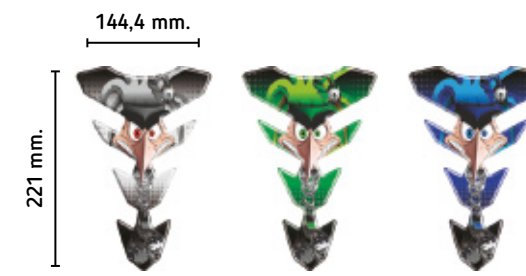

JOKER

MODEL	REF.	U V A
JOKER GREY	6496U	(*)
JOKER GREEN	6496V	(*)
JOKER BLUE	6496A	(*)

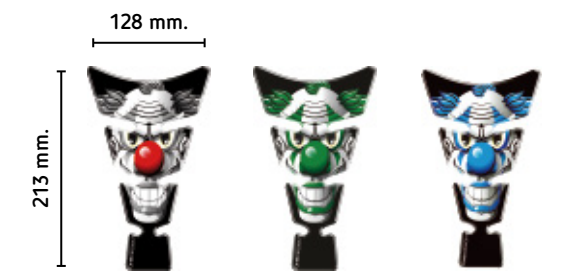
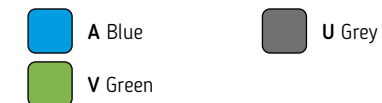

CLOWN

MODEL	REF.	U V A
CLOWN GREY	9305U	(*)
CLOWN GREEN	9305V	(*)
CLOWN BLUE	9305A	(*)

(*) Check price with your distributor.
IMPORTANT: Indicate code color after part#. Example 0973A.

NEW!

NEW!

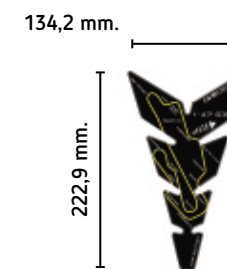
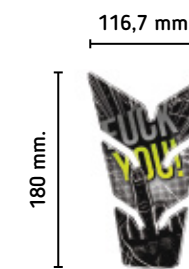
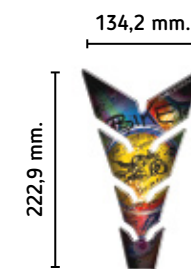
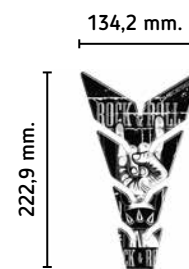
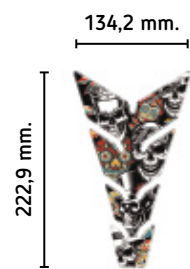

SKULL PARTY

MODEL	REF.	N
SKULL PARTY BLACK	20593N	(*)

SKULL PARTY BLACK & WHITE

MODEL	REF.	N
SKULL PARTY BLACK & WHITE	20594N	(*)

ROCK & ROLL

MODEL	REF.	N
ROCK & ROLL BLACK	20595N	(*)

BIKE

MODEL	REF.	N
BIKE BLACK	20592N	(*)

F-YOU

MODEL	REF.	N
F-YOU BLACK	20596N	(*)

MUGELLO

MODEL	REF.	N
MUGELLO BLACK	20597N	(*)

N Black

(*) Check price with your distributor.
IMPORTANT: Indicate code color after part#. Example 0973A.

N Black

(*) Check price with your distributor.
IMPORTANT: Indicate code color after part#. Example 0973A.

TANK PADS

HI-TECH PARTS

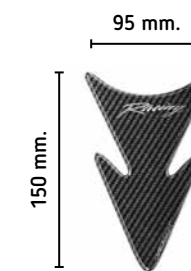
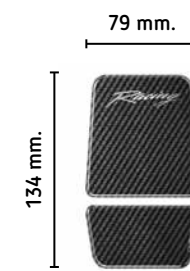
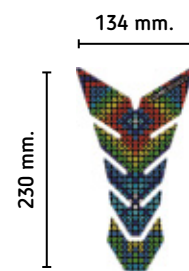
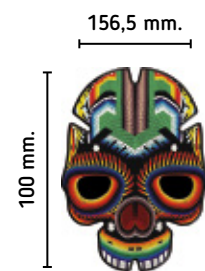

SKULL

MODEL	REF.	A R V
SKULL RED	3673R	(*)
SKULL GREEN	3673V	(*)
SKULL BLUE	3673A	(*)

SKULL I

MODEL	REF.	R
SKULL I	3674R	(*)

COLOURY

MODEL	REF.	R
COLOURY	3675R	(*)

MINI

MODEL	REF.	C
MINI CARBON LOOK	2560C	(*)

ARROW

MODEL	REF.	C
ARROW CARBON LOOK	2774C	(*)



(*) Check price with your distributor.
IMPORTANT: Indicate code color after part#. Example 0973A.



(*) Check price with your distributor.
IMPORTANT: Indicate code color after part#. Example 0973A.

TANK PADS

HI-TECH PARTS

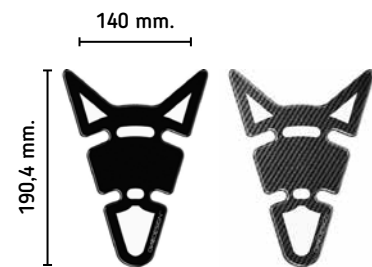

WAY

MODEL	REF.	N C
WAY BLACK	4478N	(*)
WAY CARBON LOOK	4478C	(*)

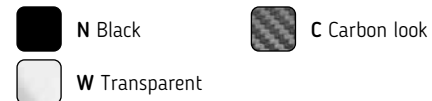

SHEETS

HI-TECH PARTS

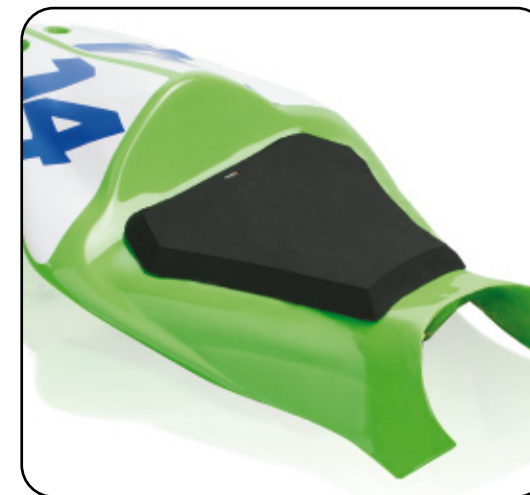

BUMPS-SHEET

MODEL	REF.	C W
1 SHEET COLOUR CARBON LOOK 250 x 350 mm	4557C	(*)
1 SHEET COLOUR TRANSPARENT 250 x 350 mm.	4558W	(*)

GRIPPING ADHESIVE SHEET, DEVELOPED TO PROTECT CERTAIN PARTS FROM BEING SCRATCHED, AND TO IMPROVE THE GRIP OF THE RIDER.
SHEET SIZE: 250 x 350 mm.

FLAT SHEET

MODEL	REF.	C
1 SHEET COLOUR CARBON	4556C	(*)

SHEET SIZE: 320 x 460 mm.

GRIPPING PADS

MODEL	REF.	N
GRIPPING PADS 170 x 93,5 mm.	9310N	(*)

ADHESIVE FOAM SEAT

MODEL	REF.	N
SHORT ADHESIVE FOAM SET - AxBxC (314 x 312 x 20 mm.)	5212N	(*)

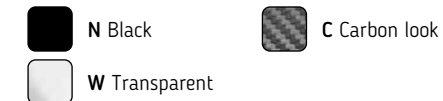

(*) Check price with your distributor.
IMPORTANT: Indicate code color after part#. Example 0973A.

(*) Check price with your distributor.
IMPORTANT: Indicate code color after part#. Example 0973A.



SCRATCH PADS PROTECTOR

HI-TECH PARTS | TECHNICAL SECTION

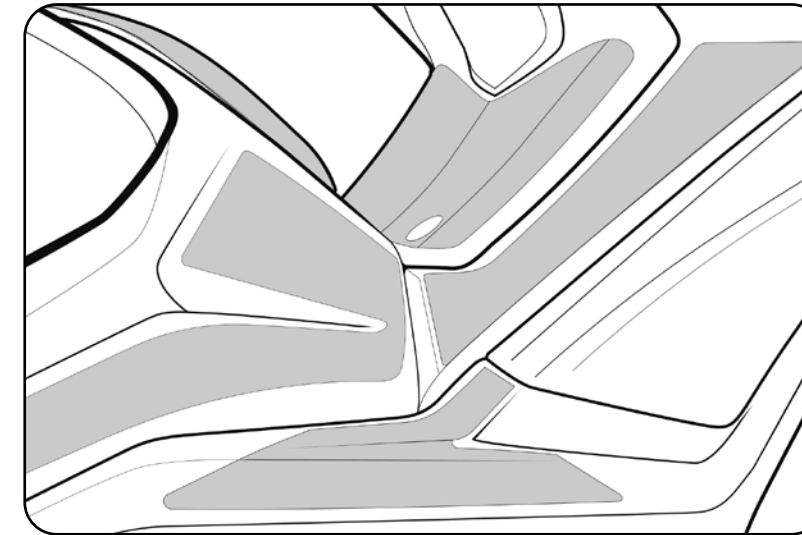

KYMCO AK550
TANKPAD SCOOTER SCRATCH SAVER



SPECIFIC DESIGN FOR EACH MODEL OF MAXISCOOTER

Protects from scratches of getting on/off the bike, as well as embellishes the plastic without altering the graphics of the Maxiscooter.

2022	For the new 2022 motorcycle models check www.puig.tv			
MODEL	YEAR	REF.	N	
BMW				
C650GT	16' - 21'	9951	(*)	
C650 SPORT	16' - 21'	20866	(*)	
HONDA				
X-ADV	17' - 20'	9952	(*)	
X-ADV	21'	20865	(*)	
KYMCO				
AK550	17' - 21'	9953	(*)	
YAMAHA				
T-MAX 530/SX/DX	17' - 19'	9954	(*)	
T-MAX 560 /SX/DX/MAX TECH	20' - 21'	9954	(*)	

■ N Black

(*) Check price with your distributor.
IMPORTANT: Indicate code color after part#. Example 0973A.

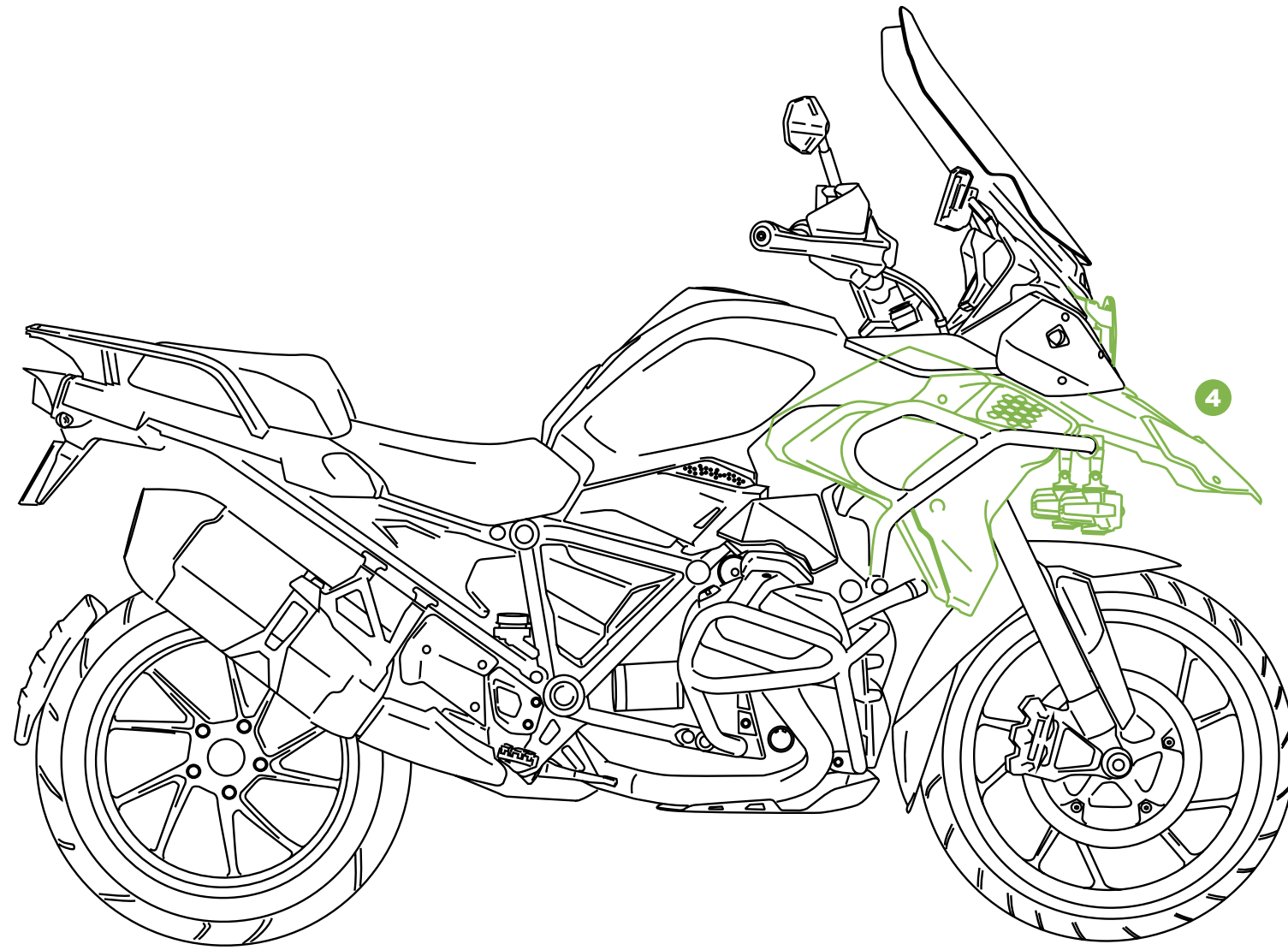

MIDDLE FRONT AREA

BEAK EXTENDER	391
CONNECTORS LEADS	432
HEADLIGHT PROTECTOR	397
HI-BEAM 2.0 AUXILIARY LIGHTS	401
HI-BEAM AUXILIARY LIGHTS	403
HI-BEAM AUXILIARY LIGHTS SUPPORTS	405
INTEGRATED TURN SIGNALS	436
LIGHTS	399
LOWER DEFLECTORS	395
RADIATOR SIDE PANELS	393
RESISTOR SET FOR LEDS TURN SIGNALS AND FLASHER RELAYS	431
SEQUENTIAL TURN SIGNALS	413
TURN SIGNAL COVERS	407
TURN SIGNALS	414



BEAK EXTENDER

HI-TECH PARTS | TECHNICAL SECTION



REF. 9174J



2022				
For the new 2022 motorcycle models check www.puig.tv				
MODEL	YEAR	REF.		ⓘ
BMW				
R1200GS	13' - 16'	9174		(*)
R1200GS	17' - 18'	9473		(*)
R1200GS EXCLUSIVE	17' - 18'	9473		(*)
R1200GS RALLYE	17' - 18'	9473		(*)
R1250GS	18' - 21'	9473		(*)
R1250GS HP	18' - 21'	9473		(*)
R1250GS RALLYE	18' - 21'	9473		(*)

2022				
For the new 2022 motorcycle models check www.puig.tv				
MODEL	YEAR	REF.		ⓘ
HONDA				
CRF1000L AFRICA TWIN	16' - 19'	3583		(*)
CRF1000L AFRICA TWIN ADVENTURE SPORTS	18' - 19'	3583		(*)
CRF1100L AFRICA TWIN	20' - 21'	3887		(*)
CRF1100L AFRICA TWIN ADVENTURE SPORTS	20' - 21'	3887		(*)
KTM				
1290 SUPER ADVENTURE R/S	17' - 20'	3662J		(*)
1290 SUPER ADVENTURE T	17'	3662J		(*)
YAMAHA				
MT-07	18' - 20'	3480		(*)
MT-07 TRACER	16' - 18'	3481		(*)
MT-09 TRACER/GT	18' - 20'	3483		(*)
MT-09 TRACER/GT	21'	3837		(*)
TENERE 700	19' - 21'	3806		(*)
XT1200Z SUPER TÉNÉRÉ	14' - 21'	3584		(*)
XT1200ZE SUPER TENERE	19' - 21'	3584		(*)

■ J Matt black

(*) Check price with your distributor.
IMPORTANT: Indicate code color after part#. Example 0973A.



RADIATOR SIDE PANELS

HI-TECH PARTS | TECHNICAL SECTION



PROTECTION
Protects the rider from inclement weather.

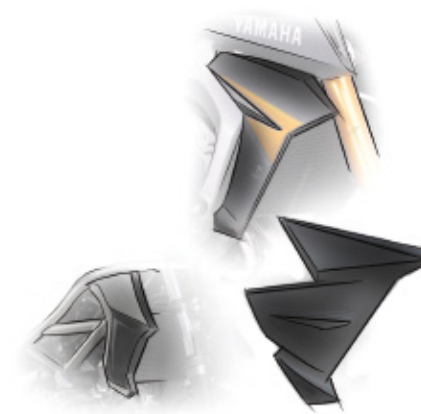



They cover the radiator's side edges and provide a continuous air flow around the rider's legs.



REF. 6880J

2022		For the new 2022 motorcycle models check www.puig.tv				
MODEL	YEAR	ADHESIVE KIT	REF.	J	C	
KAWASAKI						
Z650	17' - 19'	INCLUS	9371	(*)	(*)	
SUZUKI						
SV650	16' - 21'	INCLUS	8564	(*)	(*)	
YAMAHA						
MT-07	14' - 17'	INCLUS	7561	(*)	(*)	
MT-07	18' - 20'	INCLUS	9730	(*)	(*)	
MT-09	17'-20'	INCLUS	9378	(*)	(*)	
MT-09 SP	18' - 20'	INCLUS	9378	(*)	(*)	

-  J Matt black
-  C Carbon look

(*) Check price with your distributor.
IMPORTANT: Indicate code color after part#. Example 0973A.



LOWER DEFLECTORS

HI-TECH PARTS | TECHNICAL SECTION



REF. 9848H



REF. 1320C



LOWER DEFLECTORS

MODEL	YEAR	REF.	F	H	W
BMW					
R1200GS	13' - 18'	9848			(*)
R1200GS EXCLUSIVE	17' - 18'	9848			(*)
R1200GS RALLYE	17' - 18'	9848			(*)
R1250GS	18' - 21'	9848			(*)

FORK PROTECTOR

MODEL	REF.	C
UNIVERSAL BY PAIR C/CARBON LOOK	1320C	(*)

- H Smoke
- F Dark Smoke
- W Transparent
- C Carbon look

(*) Check price with your distributor.
IMPORTANT: Indicate code color after part#. Example 0973A.



HEADLIGHT PROTECTOR

HI-TECH PARTS | TECHNICAL SECTION

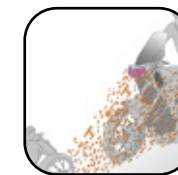

PROTECTION

Avoid impact of objects or insects on the headlight.



2022	For the new 2022 motorcycle models check www.puig.tv			
	MODEL	YEAR	REF.	Ⓜ
	BMW			
	F700 GS	12' -17'	8123W	(*)
	F750 GS	18' - 21'	9762W	(*)
	F800 GS	08'- 17'	8123W	(*)
	F850GS	18' - 21'	9762W	(*)
	F800 GS ADVENTURE	13'- 18'	8123W	(*)
	F850GS ADVENTURE	19' - 21'	3594W	(*)
	F900XR	20' - 21'	20395W	(*)
	R1200 GS	04'- 12'	7577W	(*)
	R1200 GS	13'- 18'	7567W	(*)

2022	For the new 2022 motorcycle models check www.puig.tv			
	MODEL	YEAR	REF.	Ⓜ
	R1200 GS ADVENTURE	06'- 13'	7577W	(*)
	R1200 GS ADVENTURE	14'- 18'	7567W	(*)
	R1200 GS RALLYE/EXCLUSIVE	17' - 18'	7567W	(*)
	R1250 GS	18' - 20'	7567W	(*)
	R1250 GS	21'	20814W	(*)
	R1250GS HP	18' - 20'	7567W	(*)
	R1250GS HP	21'	20814W	(*)
	R1250GS ADVENTURE	18' - 20'	7567W	(*)
	R1250GS ADVENTURE	21'	20814W	(*)
	R1250GS RALLYE	18' - 20'	7567W	(*)

Ⓜ W Transparent

(*) Check price with your distributor.
IMPORTANT: Indicate code color after part#. Example 0973A.

HEADLIGHT PROTECTOR

HI-TECH PARTS

2022	For the new 2022 motorcycle models check www.puig.tv		
MODEL	YEAR	REF.	Ⓜ
R1250GS RALLYE	21'	20814W	(*)
DUCATI			
MULTISTRADA 950	17' - 21'	9401W	(*)
MULTISTRADA 950 S	19' - 21'	9401W	(*)
MULTISTRADA 1200/S	15' - 17'	9401W	(*)
MULTISTRADA 1200 ENDURO/PRO	16' - 18'	9401W	(*)
MULTISTRADA 1260/S/S DJAIR	18' - 20'	9401W	(*)
MULTISTRADA 1260 PIKES PEAK	18' - 20'	9401W	(*)
MULTISTRADA 1260 ENDURO	19' - 20'	9401W	(*)
MULTISTRADA 1260 S GRAND TOUR	20'	9401W	(*)
MULTISTRADA V4/S/S SPORT	21'	20761W	(*)
HONDA			
CRF1000L AFRICA TWIN	16' - 19'	8714W	(*)
CRF1000L AFRICA TWIN ADVENTURE SPORTS	18' - 19'	8714W	(*)
CRF1100L AFRICA TWIN ADVENTURE SPORTS	20' - 21'	3821W	(*)
KTM			
250 ADVENTURE	21'	20416W	(*)
390 ADVENTURE	20' - 21'	20416W	(*)
790 ADVENTURE/R	19' - 21'	3758W	(*)
890 ADVENTURE	21'	20416W	(*)
890 ADVENTURE R	21'	20416W	(*)
890 ADVENTURE R RALLY	21'	20416W	(*)
1290 SUPER ADVENTURE R	17' - 20'	9470W	(*)
1290 SUPER ADVENTURE R	21'	20556W	(*)
1290 SUPER ADVENTURE S	17' - 20'	9470W	(*)
SUZUKI			
DL650 V-STROM	12' - 16'	8125W	(*)
DL650 V-STROM XT	15' - 16'	8125W	(*)
DL650 V-STROM	17' - 21'	9736W	(*)
DL650 V-STROM XT	17' - 21'	9736W	(*)
DL1000 V-STROM	15' - 16'	8126W	(*)
DL1000 V-STROM	17' - 19'	9737W	(*)
DL1000 V-STROM XT	17' - 19'	9737W	(*)
DL1050 V-STROM	20' - 21'	20413W	(*)
DL1050XT V-STROM	20' - 21'	20413W	(*)
TRIUMPH			
TIGER 800	11' - 14'	8124W	(*)
TIGER 800 XC	11' - 14'	8124W	(*)

W Transparent

2022	For the new 2022 motorcycle models check www.puig.tv		
MODEL	YEAR	REF.	Ⓜ
TIGER 800 XC/XCX/XCA	15' - 20'	8124W	(*)
TIGER 800 XR/XRX/XRT	15' - 20'	8124W	(*)
TIGER 900	20' - 21'	20377W	(*)
TIGER 900 GT	20' - 21'	20377W	(*)
TIGER 900 GT LOW	20' - 21'	20377W	(*)
TIGER 900 GT PRO	20' - 21'	20377W	(*)
TIGER 900 RALLY	20' - 21'	20377W	(*)
TIGER 900 RALLY PRO	20' - 21'	20377W	(*)
TIGER EXPLORER	12' - 15'	8124W	(*)
TIGER EXPLORER XC	13' - 15'	8124W	(*)
TIGER EXPLORER XC/XR/XRX/XRT/XCX/XCA	16' - 18'	8124W	(*)
YAMAHA			
MT-07 TRACER	16' - 19'	9215W	(*)
MT-07 TRACER	20' - 21'	20437W	(*)
MT-07 TRACER GT	19'	9215W	(*)
TENERE 700	19' - 21'	3733W	(*)
TENERE 700 RALLY EDITION	19' - 21'	3733W	(*)
XT1200Z SUPER TÉNÉRÉ	10' - 21'	8417W	(*)
XT1200ZE SUPER TENERE	19' - 21'	8417W	(*)

(*) Check price with your distributor.

IMPORTANT: Indicate code color after part#. Example 0973A.

LIGHTS

HI-TECH PARTS | TECHNICAL SECTION



REF. 1944N

LUMEN LIGHTS

HOMOLOGATED		
MODEL	REF.	Ⓝ
LED LIGHTS HOMOLOGATED 175 x 160,4 mm. 11w HIGH/9w LOW/4w POS C/BLACK	1944N	(*)



REF. 20818N

LUMEN R LIGHTS

HOMOLOGATED		
MODEL	REF.	Ⓝ
LED LIGHTS HOMOLOGATED 175 x 160,4 mm. 11w HIGH/9w LOW/4w POS C/BLACK	20818N	(*)

NEW!



REF. 3448N

MODEL	REF.	Ⓝ
OPTIC AND LIGHT H3 55w-12v LONG	3448N	(*)
OPTIC AND LIGHT H3 55w-12v SHORT	3449N	(*)

N Black

(*) Check price with your distributor.

IMPORTANT: Indicate code color after part#. Example 0973A.



HI-BEAM 2.0 AUXILIARY LIGHTS

HI-TECH PARTS | TECHNICAL SECTION

HOMOLOGATED

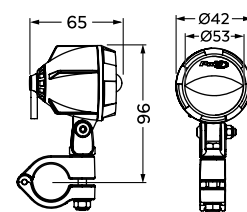
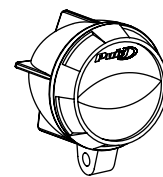

DIMENSIONS

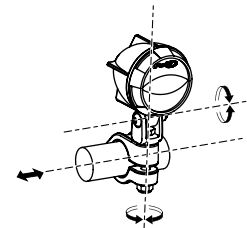

ADJUSTABLE

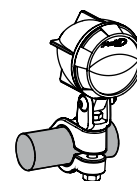

ADAPTABLE

Adjustable to 25 mm diameter tube.

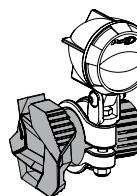

ADAPTABLE

Adjustable to R12/R19 frame sliders* with clamp Ref. 20756N

* Check that the mounting of the headlight does not interfere with the frame of the motorcycle.



Universal fog lights and aluminium case painted black.

LED technology with low power consumption, avoiding putting the battery in danger due to excessive consumption.

Supplied with instructions on our engine guards.

Equipped with a fuse and cables to connect directly to your battery and with a water proof switch to be installed on your handlebars.

Aluminum housing designed to promote heat dissipation.

TECHNICAL CHARACTERISTICS:

Low consumption: 30w (15w per light)

Voltage: DC 12v

Lumens: 2000L M(1000L M/light)

Material: PC Lenses / Aluminum housing

MODEL	REF.	N
UNIVERSAL		
SET AUXILIARY HEADLIGHTS HOMOLOGUE (1)	20755N	(*)
CLAMP SET 39 mm. FOR FRAME SLIDERS R19 (2)	20756N	(*)
SPARES		
WIRED KIT + SWITCH (3)	3541N	(*)
CLAMP SET 25,5 mm.	20831N	(*)
SWITCH (4)	20438N	(*)

AUXILIARY LIGHTS  **NEW!**

* Check availability for motorcycle models at www.puig.tv typing in the searching window.



REF. 3541N



REF. 20756N

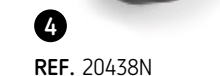

REF. 20438N



REF. 20755N

 N Black

SPECIFIC SUPPORTS FOR AUXILIARY LIGHTS SEE PAGE 405.

(*) Check price with your distributor.
IMPORTANT: Indicate code color after part#. Example 0973A.

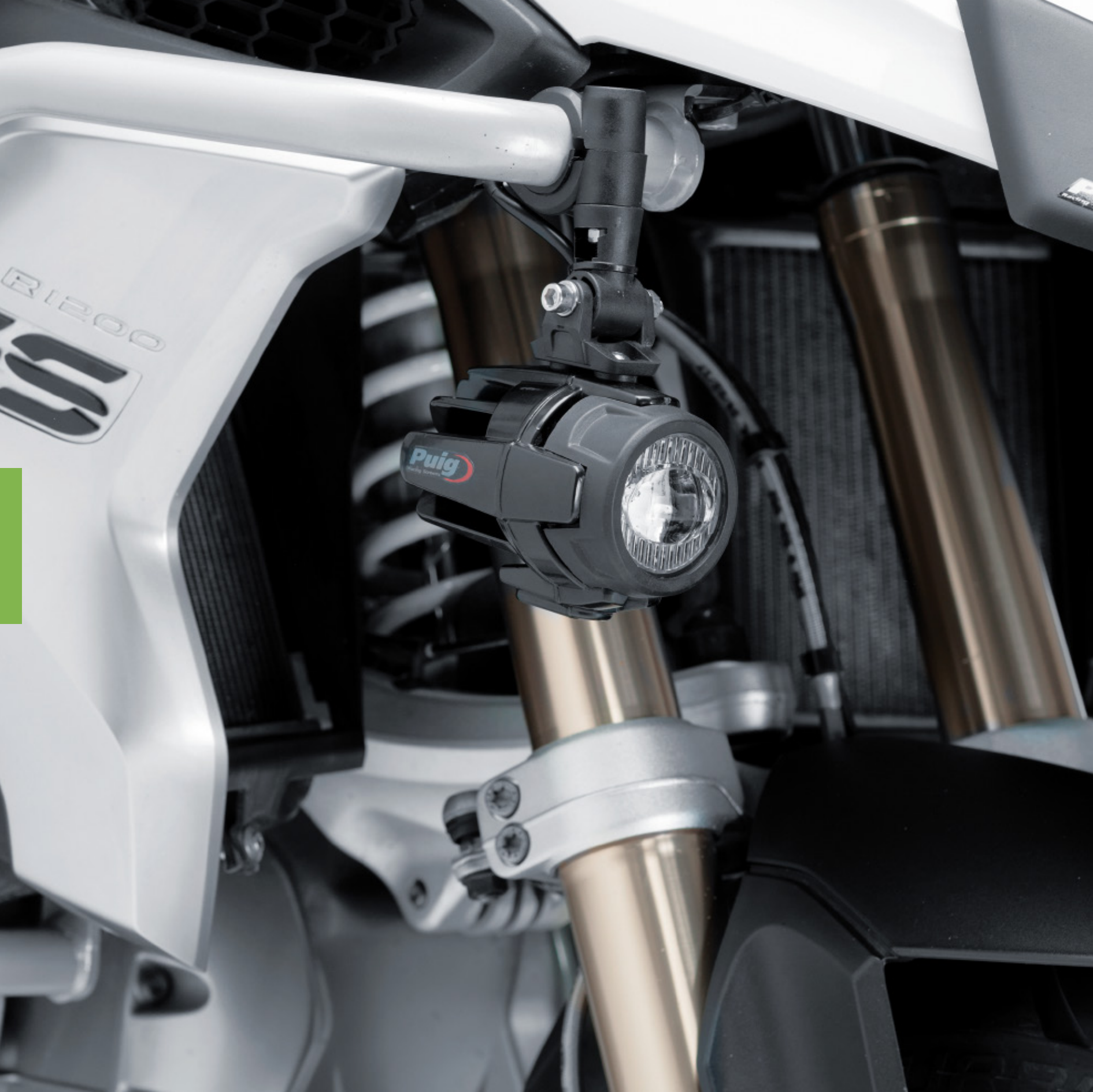

HI-BEAM AUXILIARY LIGHTS

HI-TECH PARTS | TECHNICAL SECTION

HOMOLOGATED

Universal fog lights and aluminium case painted black.

LED technology with low power consumption, avoiding putting the battery in danger due to excessive consumption.

Supplied with instructions on our engine guards. Fit engine guards between 23 and 25 mm diameter.

Equipped with a fuse and cables to connect directly to your battery and with a water proof switch to be installed on your handlebars.

Aluminum housing designed to promote heat dissipation.

Optional metallic grill protections for offroad use.

Sells separately (Ref. 9785N)

TECHNICAL CHARACTERISTICS:

Low consumption: 40w (20w per light)

Voltage: DC 12-24v

Lumens: 4000L M(2000L M/light)

Material: PC Lenses / Aluminum housing

MOUNTING: To mount the auxiliary lights on the Puig engine guards use only one of the two spacers that carries the support and the allen screw M6 x 50.



■ N Black

AUXILIARY LIGHTS

* Check availability for motorcycle models at www.puig.tv typing in the searching window.



MODEL	REF.	N
SET AUXILIARY HEADLIGHTS HOMOLOGUE (1)	3489N	(*)
SET PROTECTION GRID (2)	9785N	(*)
WIRED KIT + SWITCH (3)	3541N	(*)
CLAMP + SUPPORT AUXILIARY LIGHTS (4)	3635N	(*)
SWITCH (5)	20438N	(*)
AUXILIARY HEADLIGHT HOMOLOGATED - UNIT (6)	20815N	(*)

SPECIFIC SUPPORTS FOR AUXILIARY LIGHTS SEE PAGE 405.

(*) Check price with your distributor.
IMPORTANT: Indicate code color after part#. Example 0973A.



HI-BEAM AUXILIARY LIGHTS SUPPORTS

HI-TECH PARTS | TECHNICAL SECTION

FUNCTION

Allow mounting of the lights on bikes that don't mount tube engine guards.



MATERIAL

Made of steel.
Finished with epoxy black paint.



ADJUSTABLE

Sideways and on inclination.



REF. 1943N

2022	For the new 2022 motorcycle models check www.puig.tv			
	SPECIFIC SUPPORTS	YEAR	REF.	N
	BMW			
	G310GS	17' - 20'	3487N	(*)
	F850GS	18' - 20'	3642N	(*)
	R NINE T	14' - 20'	3486N	(*)
	HONDA			
	CB500F	16' - 18'	3550N	(*)
	CB500X	19' - 20'	3573N	(*)
	CB650R NEO SPORTS CAFÉ	19' - 21'	3529N	(*)
	CB1000R NEO SPORTS CAFE	18' - 21'	1943N	(*)
	CB1000R BLACK EDITION	21'	1943N	(*)
	CRF1000L AFRICA TWIN	16' - 17'	3537N	(*)
	CRF1100L AFRICA TWIN	20'	3870N	(*)
	CRF1100L AFRICA TWIN ADVENTURE SPORTS	20'	3870N	(*)
	KAWASAKI			
	VERSYS 650	15' - 21'	3156N	(*)
	VERSYS 1000	17' - 20'	3502N	(*)

N Black

2022	For the new 2022 motorcycle models check www.puig.tv			
	SPECIFIC SUPPORTS	YEAR	REF.	N
	Z900	17' - 21'	3549N	(*)
	KTM			
	790 DUKE	18' - 21'	3643N	(*)
	SUZUKI			
	DL650 V-STROM/XT	17' - 21'	3145N	(*)
	KATANA	19' - 21'	3652N	(*)
	SV650	16' - 21'	3485N	(*)
	TRIUMPH			
	TIGER 800 XC/XCX/XCA/XR/XRX/XRT	18' - 20'	1350N	(*)
	STREET TRIPLE RS	17' - 19'	3536N	(*)
	YAMAHA			
	TENERE 700	19' - 21'	3816N	(*)
	TENERE 700 RALLY EDITION	19' - 21'	3816N	(*)
	XT1200Z SUPER TÉNÉRÉ	18' - 21'	3644N	(*)
	XT1200ZE SUPER TENERE	19'-21'	3644N	(*)

(*) Check price with your distributor.
IMPORTANT: Indicate code color after part#. Example 0973A.



TURN SIGNAL COVERS

HI-TECH PARTS | TECHNICAL SECTION



MATERIAL

Made of steel.
Finished with epoxy
black paint.



OPTICS

Hides the gap that leaves
the OEM turn signal when
it is replaced.

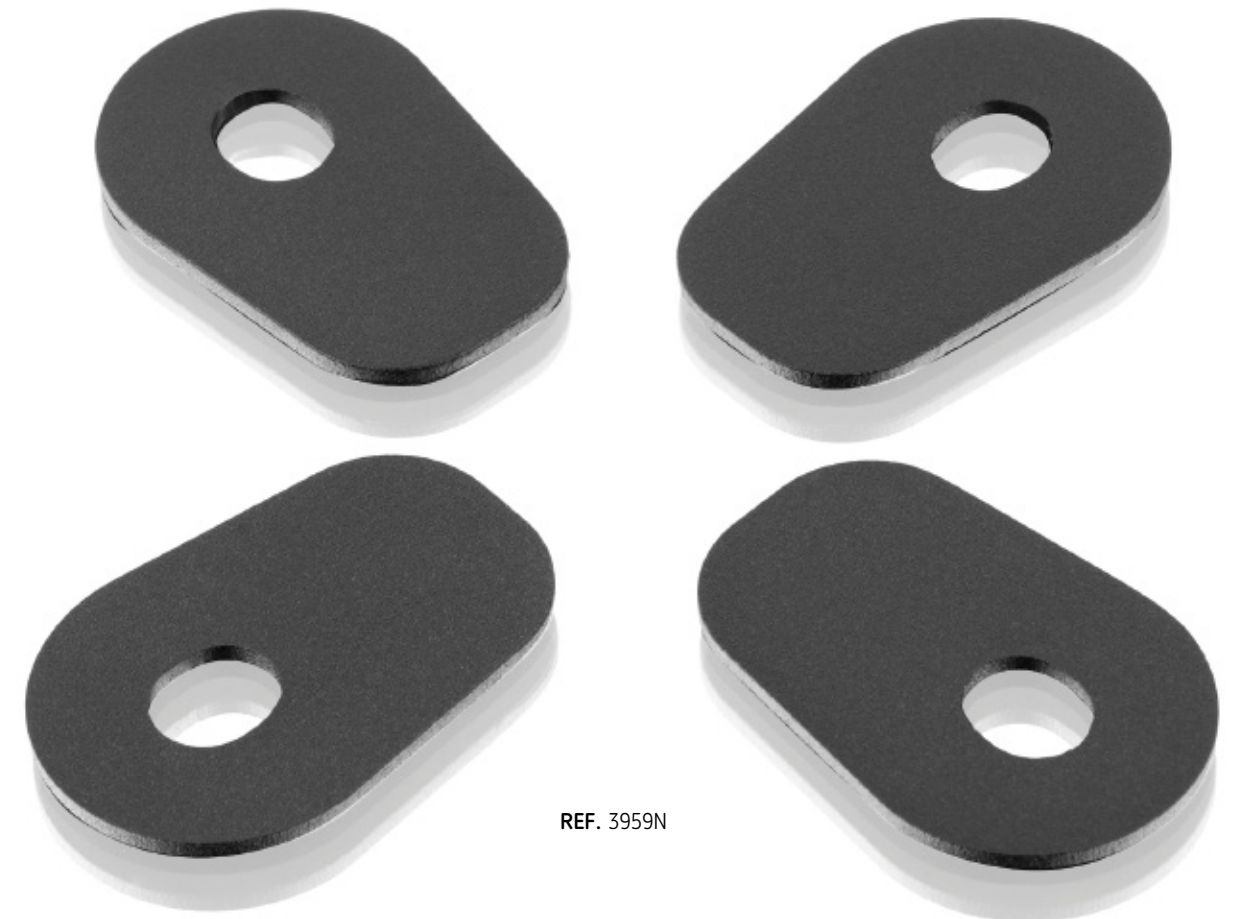

REF. 3959N

■ N Black

FOR SPECIFIC MODELS SEE PAGE 408.

TURN SIGNAL COVERS

HI-TECH PARTS | TYPE OF TURN SIGNAL COVERS:

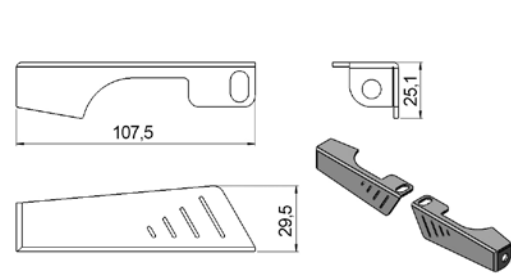

REF. 3507

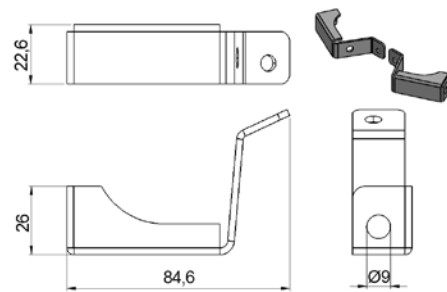

REF. 3528

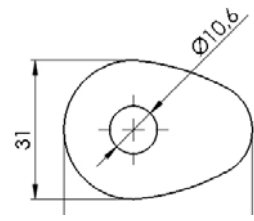

REF. 3956

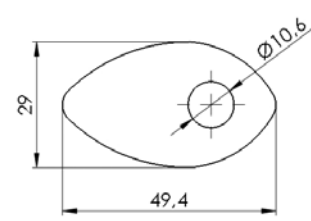

REF. 3957

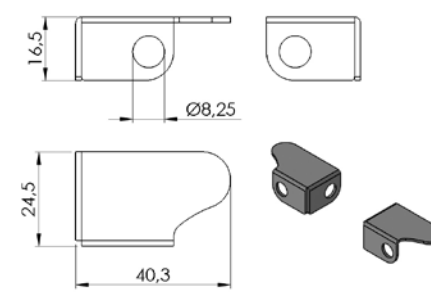

REF. 9735

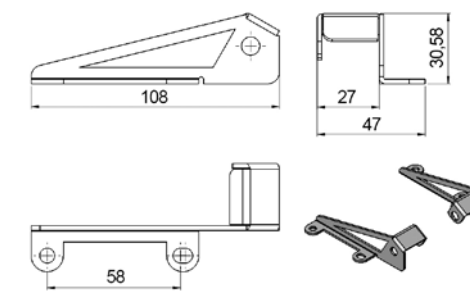

REF. 9740

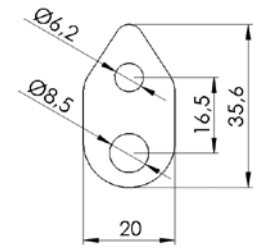

REF. 9765

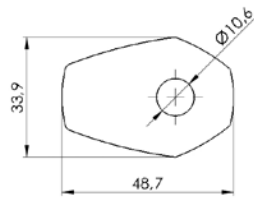

REF. 3958

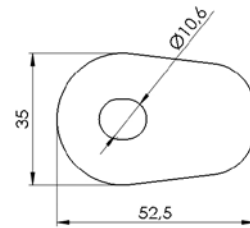

REF. 3959

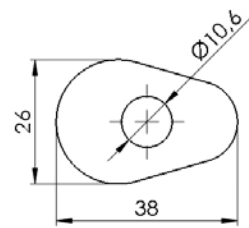

REF. 3960

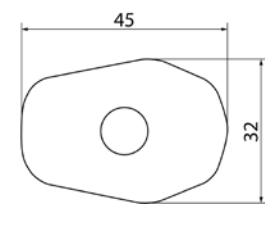

REF. 4751

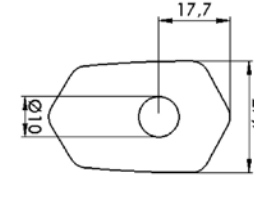

REF. 9788

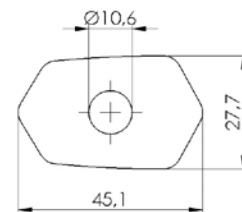

REF. 5329

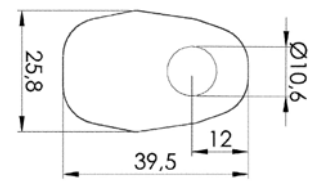

REF. 9453

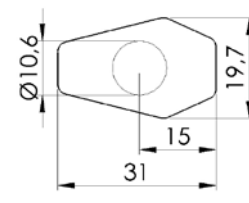

REF. 9655

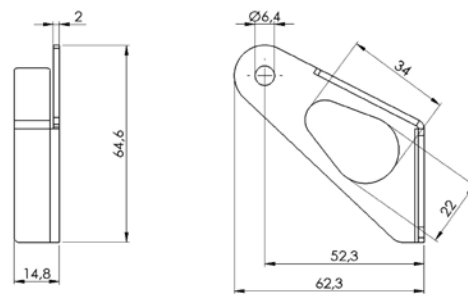

REF. 9465

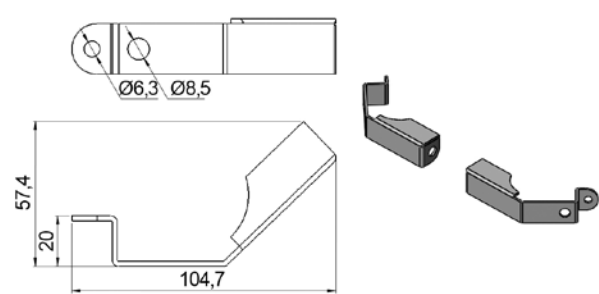

REF. 9672

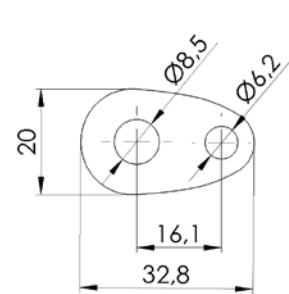

REF. 9676

2022		For the new 2022 motorcycle models check www.puig.tv		
MODEL	YEAR	REF.	N	
HARLEY DAVIDSON				
SPORTSTER 883 IRON	16' - 20'	9735 (#)	(*)	
HONDA				
CB125F	15' - 20'	3957	(*)	
CB300F	15' - 20'	3957	(*)	
CB500F/X	13' - 18'	3957	(*)	
CB500F/X	19' - 21'	3957	(*)	
CB600F HORNET	00' - 15'	3957	(*)	
CB650F	14' - 20'	3957	(*)	
CB900F HORNET	02' - 05'	3957	(*)	
CB125R NEO SPORTS CAFE	18' - 20'	9655	(*)	
CB300R NEO SPORTS CAFE	18' - 21'	9655	(*)	
CB650R NEO SPORTS CAFÉ	19' - 21'	3528	(*)	
CB1000R	08' - 16'	3957	(*)	
CBF1000F	10' - 16'	3957	(*)	

2022		For the new 2022 motorcycle models check www.puig.tv		
MODEL	YEAR	REF.	N	
CBR125R	11' - 20'	3957	(*)	
CBR250R	11' - 14'	3957	(*)	
CBR300R	15' - 17'	3957	(*)	
CBR500R	13' - 21'	3957	(*)	
CBR600F	86' - 13'	3957	(*)	
CBR600F	86' - 13'	3957	(*)	
CBR600RR	03' - 16'	3957	(*)	
CBR650F	14' - 20'	3957	(*)	
CBR650R	19' - 21'	9655	(*)	
CBR1000RR FIREBLADE	04' - 13'	3957	(*)	
CBR1000RR FIREBLADE/SP	14' - 16'	3957	(*)	
CROSSRUNNER	11' - 21'	3957	(*)	
CROSSTOURER	12' - 21'	3957	(*)	
CRF1100L AFRICA TWIN	20'	20532	(*)	
CRF1100L AFRICA TWIN ADVENTURE SPORTS	20'	20532	(*)	

N Black

(#) Bracket set front Puig turn signals.
 (S) Bracket set rear Puig turn signals.
 (*) Bracket set front Puig turn signals + Turn Signals Ref.4489K.
 (**) Check price with your distributor.
IMPORTANT: Indicate code color after part#. Example 0973A.

TURN SIGNAL COVERS

HI-TECH PARTS

2022	For the new 2022 motorcycle models check www.puig.tv			
MODEL	YEAR	REF.	N	
CMX 500 REBEL	17' - 21'	9672 (#)	(*)	
INTEGRA 750	16' - 21'	3957	(*)	
INTEGRA 750S	14' - 16'	3957	(*)	
NC700S/X	12' - 13'	3957	(*)	
NC750S/X	14' - 20'	3957	(*)	
NC750S	21'	3957	(*)	
MSX125	14' - 20'	3957	(*)	
INDIAN				
SCOUT BOBBER	18' - 21'	9740 (#)	(*)	
SCOUT BOBBER	18' - 21'	9765 (&)	(*)	
KAWASAKI				
ER-6N/F	12' - 16'	5329	(*)	
NINJA 250SL	15' - 16'	5329	(*)	
NINJA 300	13' - 17'	5329	(*)	
NINJA 400	18' - 21'	5329	(*)	
NINJA 650	17' - 21'	5329	(*)	
VERSYS-X 300	17' - 20'	5329	(*)	
VERSYS 650	07' - 09'	3959	(*)	
VERSYS 650	10' - 21'	5329	(*)	
VERSYS 1000	12' - 20'	5329	(*)	
VULCAN S	15' - 21'	9676 (#)	(*)	
VULCAN S CAFE	17' - 20'	9676 (#)	(*)	
Z250SL	15' - 16'	5329	(*)	
Z300	15' - 17'	5329	(*)	
Z650	17' - 21'	5329	(*)	
Z750	07' - 12'	3959	(*)	
Z750S	05' - 06'	3959	(*)	
Z750R	11' - 12'	5329	(*)	
Z800/E	13' - 16'	5329	(*)	
Z900	17' - 21'	5329	(*)	
Z900	17' - 19'	9788 (*)	(*)	
Z900RS	18' - 21'	5329	(*)	
Z900RS CAFÉ	18' - 21'	5329	(*)	
Z1000	10' - 19'	5329	(*)	
Z1000R	17' - 21'	5329	(*)	
Z1000SX	14' - 19'	5329	(*)	
ZH2	20' - 21'	5329	(*)	

2022	For the new 2022 motorcycle models check www.puig.tv			
MODEL	YEAR	REF.	N	
ZR7S	01' - 03'	3959	(*)	
ZRX1200S	01' - 07'	3959	(*)	
ZX-6R	94' - 04'	3959	(*)	
ZX-6R 636	13' - 16'	5329	(*)	
ZX-9R	94' - 04'	3959	(*)	
ZX-10R	04' - 05'	3959	(*)	
ZX-12R	00' - 06'	3959	(*)	
SUZUKI				
DL250 V-STROM	17' - 21'	3956	(*)	
DL650 V-STROM	12' - 21'	3958	(*)	
DL650XT V-STROM	15' - 21'	3958	(*)	
DL1000 V-STROM	14' - 19'	3958	(*)	
DL1000XT V-STROM	14' - 19'	3958	(*)	
GSF600 BANDIT	96' - 99'	3956	(*)	
GSF600 BANDIT	00' - 04'	3958	(*)	
GSF650 BANDIT	05' - 11'	3958	(*)	
GSF650S BANDIT	05' - 14'	3958	(*)	
GSF1200 BANDIT	01' - 06'	3958	(*)	
GSF1250S BANDIT	07' - 13'	3958	(*)	
GSF1250S BANDIT	15' - 16'	3958	(*)	
GSR750	11' - 16'	3958	(*)	
GSX650F	08' - 17'	3958	(*)	
GSX1250F	10' - 17'	3958	(*)	
GSX-S125	17' - 21'	3956	(*)	
GSX-S750	17' - 21'	3958	(*)	
GSX-S1000	15' - 21'	3958	(*)	
GSX-S1000F	15' - 21'	3958	(*)	
GSX-R125	17' - 21'	3956	(*)	
GSX-R250	17' - 21'	3956	(*)	
GSX-R600/750	96' - 00'	3956	(*)	
GSX-R600/750	01' - 05'	3958	(*)	
GSX-R1000	01' - 04'	3958	(*)	
GSX-R1000	15' - 16'	3958	(*)	
INAZUMA	13' - 17'	3956	(*)	
SFV650 GLADIUS	09' - 15'	3958	(*)	
SV650	16' - 21'	3958	(*)	
SV650S	03' - 08'	3958	(*)	

2022	For the new 2022 motorcycle models check www.puig.tv			
MODEL	YEAR	REF.	N	
SV1000S	03' - 05'	3956	(*)	
YAMAHA				
FAZER8	13' - 16'	3960	(*)	
FJR1300A/AS	06' - 21'	3959	(*)	
FZ1/FAZER	06' - 15'	3960	(*)	
FZ6	04' - 06'	3960	(*)	
FZ6 FAZER	07' - 08'	3960	(*)	
FZ8 FAZER	10' - 12'	3960	(*)	
FZS600/1000 FAZER	01' - 05'	3959	(*)	
MT-125	15' - 21'	3960	(*)	
MT-03	16' - 21'	3960	(*)	
MT-07	14' - 21'	3960	(*)	
MT-07 TRACER	16' - 21'	3960	(*)	
MT-07 TRACER GT	20' - 21'	3960	(*)	
MT-09	13' - 20'	3960	(*)	
MT-09	21'	20867	(*)	
MT-09 SP	21'	20867	(*)	
MT-09 TRACER	15' - 21'	3960	(*)	
MT-09 TRACER GT	18' - 20'	3960	(*)	
MT-10	16' - 21'	3960	(*)	
MT-10 SP	17' - 21'	3960	(*)	
TDM900	02' - 13'	3960	(*)	
TENERE 700	19' - 21'	3960	(*)	
XJ6	09' - 16'	3960	(*)	
XJ6 DIVERSION	09' - 16'	3960	(*)	
XJ6 DIVERSION F	10' - 16'	3960	(*)	
XSR 125	21'	3960	(*)	
XSR700	16' - 21'	3960	(*)	
XSR700 XTRIBUTE	19' - 21'	3960	(*)	
XSR900	16' - 21'	3960	(*)	
XV950	14' - 21'	3507(#)	(*)	
XV950R	14' - 21'	3507(#)	(*)	
XV950 RACER	14' - 21'	3507(#)	(*)	
XT660Z TÉNÉRÉ	12' - 16'	3959	(*)	
YZF 600 R THUNDERCAT	96' - 02'	3959	(*)	
YZF 1000 R THUNDERACE	96' - 03'	3959	(*)	
YZF-R125	19' - 21'	3960	(*)	

2022	For the new 2022 motorcycle models check www.puig.tv			
MODEL	YEAR	REF.	N	
YZF-R1	98' - 01'	3959	(*)	
YZF-R1	02' - 14'	3960	(*)	
YZF-R1	20' - 21'	3960	(*)	
YZF-R1M	20' - 21'	3960	(*)	
YZF-R3	15' - 21'	3960	(*)	
YZF-R6	99' - 02'	3959	(*)	
YZF-R6	03' - 16'	3960	(*)	
YZF-R6	17' - 20'	3960	(*)	

N Black

(#) Bracket set front Puig turn signals.
 (&) Bracket set rear Puig turn signals.
 (*) Bracket set front Puig turn signals + Turn Signals Ref.4489K.
 (*) Check price with your distributor.
IMPORTANT: Indicate code color after part#. Example 0973A.

N Black

(#) Bracket set front Puig turn signals.
 (&) Bracket set rear Puig turn signals.
 (*) Bracket set front Puig turn signals + Turn Signals Ref.4489K.
 (*) Check price with your distributor.
IMPORTANT: Indicate code color after part#. Example 0973A.



SEQUENTIAL TURN SIGNALS

HI-TECH PARTS | TECHNICAL SECTION

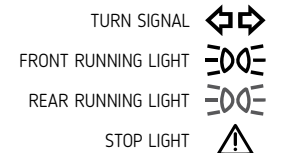

THIN

HOMOLOGATED

MODEL	REF.	N
SET OF SEQUENTIAL COLOR BLACK WITH CLEAR LENS OF 12 LEDS 76 x 27,40 mm.	9624N	(*)

We cannot guarantee the universality of this turn signal on all motorcycle models.



TOWER

HOMOLOGATED

MODEL	REF.	N
SET OF SEQUENTIAL COLOR BLACK WITH CLEAR LENS OF 8 LEDS 70 x 24 mm. 12v 0,5w	20424N	(*)

We cannot guarantee the universality of this turn signal on all motorcycle models.

 N Black



PIN

HOMOLOGATED

MODEL	REF.	N
SET OF SEQUENTIAL COLOR BLACK WITH CLEAR LENS OF 8 LEDS 70,20 x 24,30 mm.	3155N	(*)

We cannot guarantee the universality of this turn signal on all motorcycle models.



NEW!

FUN

HOMOLOGATED

MODEL	REF.	N
SET OF SEQUENTIAL COLOR BLACK WITH CLEAR LENS OF 12 LEDS 75 x 33,60 mm.	20698N	(*)

We cannot guarantee the universality of this turn signal on all motorcycle models.

CHECK CONNECTIONS TURN SIGNALS ON PAGE 432.
TO AVOID CONECTION PROBLEMS. CHECK THE TECHNICAL SHEET ON PAGE 431.

TURN SIGNALS

HI-TECH PARTS | TECHNICAL SECTION

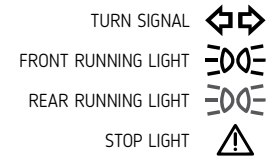
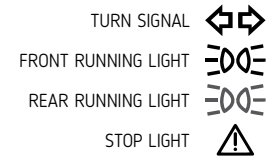

PIRAMIDE

HOMOLOGATED

MODEL	REF.	N
SET BLACK CLEAR LENSES LED 59,15 x 33,54 mm. 12v 0,5w	9941N	(*)

CHIP

HOMOLOGATED

MODEL	REF.	N
SET BLACK CLEAR LENSES LED 24 x 16 mm. 12v 0,4w	9942N	(*)

SPARKLY

HOMOLOGATED

MODEL	REF.	N
SET BLACK CLEAR LENSES LED 138,43 x 45,12 mm. 12v 0,5w	9944N	(*)

HOUSE

HOMOLOGATED

MODEL	REF.	N
SET BLACK CLEAR LENSES LED 7 0 x 24 mm. 12v 0,5w	9946N	(*)

N Black

CHECK CONNECTIONS TURN SIGNALS ON PAGE 432.
TO AVOID CONECTION PROBLEMS. CHECK THE TECHNICAL SHEET ON PAGE 431.

N Black

CHECK CONNECTIONS TURN SIGNALS ON PAGE 432.
TO AVOID CONECTION PROBLEMS. CHECK THE TECHNICAL SHEET ON PAGE 431.

TURN SIGNALS

HI-TECH PARTS | TECHNICAL SECTION

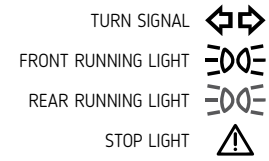
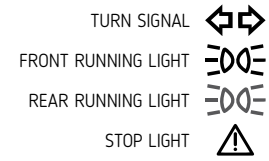

BUOY

HOMOLOGATED

MODEL	REF.	N
SET BLACK CLEAR LENSES LED 78 x 33 mm. 12v 5w	9947N	(*)

Milled from aluminum dough.
They are fixed as a handlebar terminal.
Suitable for handlebars inner diameter from 18 mm.

BUOY II

HOMOLOGATED

MODEL	REF.	N
SET BLACK CLEAR LENSES LED 77,80 x 33 mm. 12v 5w	9948N	(*)

Injected metallic.
They are fixed as a handlebar terminal.
Suitable for handlebars inner diameter from 18 mm.

TINY

HOMOLOGATED

MODEL	REF.	N
SET BLACK SMOKED LENSES LED 27 x 34,20 mm. 12v 1w	9314N	(*)

N Black

MINIMAL

HOMOLOGATED

MODEL	REF.	N
JLED TURN SIGNAL BLACK BASE SHORT STEMP/ CLEAR LENS BY PAIR 45 x 20 mm. 12v 0,6w	4906N	(*)
LED TURN SIGNAL BLACK BASE LONG STEMP/ CLEAR LENS BY PAIR 60 x 20 mm. 12v 0,8w	4907N	(*)

CHECK CONNECTIONS TURN SIGNALS ON PAGE 432.
TO AVOID CONECTION PROBLEMS. CHECK THE TECHNICAL SHEET ON PAGE 431.

TURN SIGNALS

HI-TECH PARTS | TECHNICAL SECTION

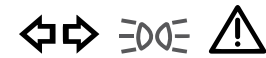
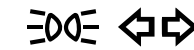
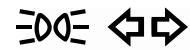
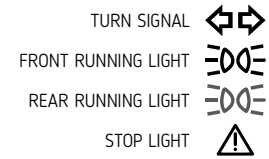
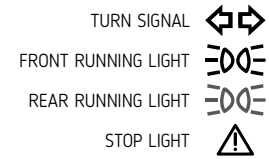

LIGHT

HOMOLOGATED

MODEL	REF.	N
FRONT SET OF BLACK COLOR WITH SMOKED LENSES OF 50,80 x 25,30 mm. POSITION + TURN SIGNAL	9315N	(*)
REAR SET OF BLACK COLOR WITH SMOKED LENSES OF 50,80 x 25,30 mm. POSITION + STOP + TURN SIGNAL	9557N	(*)

DOUBLE

HOMOLOGATED

MODEL	REF.	N
FRONT SET OF BLACK COLOR WITH SMOKED LENSES OF 58,20 x 43,30 mm. POSITION + TURN SIGNAL	9316N	(*)

STICK

HOMOLOGATED

MODEL	REF.	N
FRONT SET OF BLACK COLOR WITH SMOKED LENSES OF 48 x 20 mm. POSITION + TURN SIGNAL	9317N	(*)
REAR SET OF BLACK COLOR WITH SMOKED LENSES OF 48 x 20 mm. POSITION + STOP + TURN SIGNAL	9555N	(*)

OPEN

HOMOLOGATED

MODEL	REF.	N
SET BLACK CLEAR LENSES LED 47,3 x 26,5 mm. 12v 2w	8997N	(*)

N Black

CHECK CONNECTIONS TURN SIGNALS ON PAGE 432.
TO AVOID CONECTION PROBLEMS. CHECK THE TECHNICAL SHEET ON PAGE 431.

N Black

CHECK CONNECTIONS TURN SIGNALS ON PAGE 432.
TO AVOID CONECTION PROBLEMS. CHECK THE TECHNICAL SHEET ON PAGE 431.

TURN SIGNALS

HI-TECH PARTS | TECHNICAL SECTION

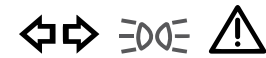
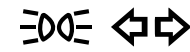
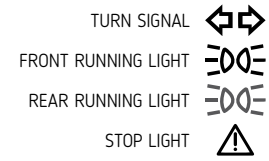
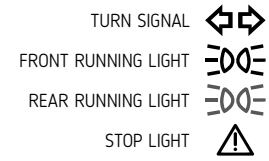

CURVE

HOMOLOGATED

MODEL	REF.	N
FRONT SET BLACK CLEAR LENSES LED 49,50 x 25 mm. POSITION + TURN SIGNAL	9084N	(*)
REAR SET BLACK CLEAR LENSES LED 49,50 x 25 mm. POSITION + STOP + TURN SIGNAL	9151N	(*)



RUBI

HOMOLOGATED

MODEL	REF.	C
SET CARBON LOOK CLEAR LENSES LED 53,30 x 28,10 mm. 12v 1w	4919	(*)



POWER LED

HOMOLOGATED



MODEL	REF.	N
SET BLACK CLEAR LENSES LED 70,15 x 21,76 mm. 12v 1w	5609N	(*)



PUTT

HOMOLOGATED

MODEL	REF.	N
SET BLACK CLEAR LENSES LED 62,8 x 15,4 mm. 12v 2w	3734N	(*)

 C Carbon look
 N Black

CHECK CONNECTIONS TURN SIGNALS ON PAGE 432.
 TO AVOID CONECTION PROBLEMS. CHECK THE TECHNICAL SHEET ON PAGE 431.

 N Black

CHECK CONNECTIONS TURN SIGNALS ON PAGE 432.
 TO AVOID CONECTION PROBLEMS. CHECK THE TECHNICAL SHEET ON PAGE 431.

TURN SIGNALS

HI-TECH PARTS | TECHNICAL SECTION

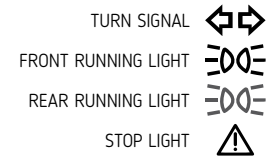
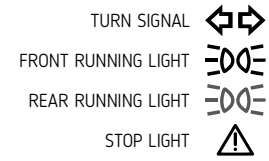

SNAKE

HOMOLOGATED

MODEL	REF.	
SET BLACK CLEAR LENSES LED 80 x 28,3 mm. 12v 1w	5239N	(*)

FLECHA

HOMOLOGATED

MODEL	REF.	
LED TURN SIGNAL SHORT ARM CLEAR LENS 67 x 30 mm. 12v 2w	4173W	(*)
LED TURN SIGNAL LONG ARM CLEAR LENS 87 x 30 mm. 12v 2w	4174W	(*)

ZAFIRO

HOMOLOGATED

MODEL	REF.	
LED TURN SIGNAL SHORT ARM CLEAR LENS 73 x 35 mm. 12v 1w	2585W	(*)
LED TURN SIGNAL LONG ARM CLEAR LENS 93 x 35 mm. 12v 1w	2586W	(*)

LANZA

HOMOLOGATED

MODEL	REF.		
LED TURN SIGNAL BLACK BASE/CLEAR LENS BY PAIR 79 x 33 mm. 12v 0,9w	4824N	(*)	

W Transparent
 N Black

D Anodized
 W Transparent
 N Black

CHECK CONNECTIONS TURN SIGNALS ON PAGE 432.
TO AVOID CONECTION PROBLEMS. CHECK THE TECHNICAL SHEET ON PAGE 431.

CHECK CONNECTIONS TURN SIGNALS ON PAGE 432.
TO AVOID CONECTION PROBLEMS. CHECK THE TECHNICAL SHEET ON PAGE 431.

TURN SIGNALS

HI-TECH PARTS | TECHNICAL SECTION

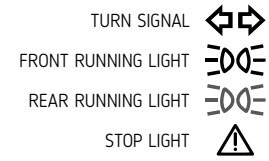
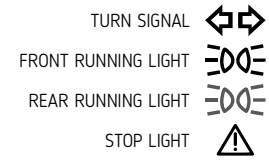

PEAK

HOMOLOGATED

MODEL	REF.	N	C
LED TURN SIGNAL BLACK BASE SHORT STEMP/ CLEAR LENS BY PAIR 66 x 27 mm. 12v 0,5w	4491N	(*)	
LED TURN SIGNAL BLACK BASE LONG STEMP/ CLEAR LENS BY PAIR 86 x 27 mm. 12v 0,5w	4492N	(*)	
LED TURN SIGNAL CARBON LOOK BASE SHORT STEMP/ CLEAR LENS BY PAIR 66 x 27 mm. 12v 0,5w	4493C	(*)	
LED TURN SIGNAL CARBON LOOK BASE LONG STEMP/ CLEAR LENS BY PAIR 86 x 27 mm. 12v 0,5w	4494C	(*)	

C Carbon look

N Black

CHECK CONNECTIONS TURN SIGNALS ON PAGE 432.
TO AVOID CONECTION PROBLEMS. CHECK THE TECHNICAL SHEET ON PAGE 431.

CIGAR

HOMOLOGATED

MODEL	REF.	N
SET BLACK CLEAR LENSES LED 91 x 20 mm. 12v 1,4w	4346N	(*)

N Black

AX

HOMOLOGATED

MODEL	REF.	N
SET BLACK CLEAR LENSES LED 63,4 x 18,2 mm. 12v 1w	5510N	(*)

CHECK CONNECTIONS TURN SIGNALS ON PAGE 432.
TO AVOID CONECTION PROBLEMS. CHECK THE TECHNICAL SHEET ON PAGE 431.

TURN SIGNALS

HI-TECH PARTS | TECHNICAL SECTION

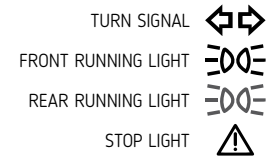
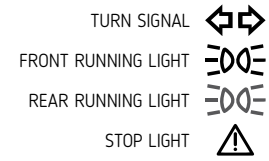

SPEED

NOT HOMOLOGATED

MODEL	REF.	T
BLACK BASE/ AMBER LENS BY PAIR 60 x 19 mm.	(*) 2546T	(*)
CARBON LOOK BASE/ AMBER LENS BY PAIR 60 x 19 mm. 12v 2,16w	(*) 1077T	(*)

(*) These models cannot be homologated, because do not fulfill the EU standards, their C-Carbon Look use limited for tradeshows exclusively, closed exhibitions and for race tracks.

BALA

HOMOLOGATED

MODEL	REF.	T
BLACK BASE/ AMBER LEN x UNIT 78 x 87 mm.	0911T	(*)

T Orange

CHECK CONNECTIONS TURN SIGNALS **ON PAGE 432.**
TO AVOID CONECTION PROBLEMS. CHECK THE TECHNICAL SHEET **ON PAGE 431.**

T Orange

CHECK CONNECTIONS TURN SIGNALS **ON PAGE 432.**
TO AVOID CONECTION PROBLEMS. CHECK THE TECHNICAL SHEET **ON PAGE 431.**

TURN SIGNALS

HI-TECH PARTS | TECHNICAL SECTION

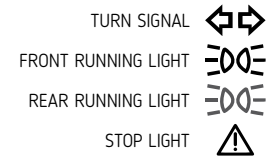

STAR

HOMOLOGATED

MODEL	REF.	PRICE
LED TURN SIGNAL CARBON LOOK BASE SHORT STEMP/ AMBER LENS + SMOKE LENS + LASER LENS BY PAIR 70 x 35 mm. 12v 21w	2548C	(*)
LED TURN SIGNAL CARBON LOOK BASE LONG STEMP/ AMBER LENS + SMOKE LENS + LASER LENS BY PAIR 90 x 35 mm. 12v 21w	2549C	(*)
LED TURN SIGNAL BLACK BASE SHORT STEMP/ AMBER LENS + SMOKE LENS + LASER LENS BY PAIR 69 x 42 mm. 12v 21w	4175N	(*)
LED TURN SIGNAL BLACK BASE LONG STEMP/ AMBER LENS + SMOKE LENS + LASER LENS BY PAIR 89 x 42 mm. 12v 21w	4176N	(*)
AMBER BULB STAR TURN SIGNAL 12v-23w (BOX 10 UNITS)	1622T	(*)
CLEAR BULB STAR TURN SIGNAL 12v-23w (BOX 10 UNITS)	1622W	(*)
AMBER BULB STAR TURN SIGNAL 12v-6w (BOX 10 UNITS)	4596T	(*)
CLEAR BULB STAR TURN SIGNAL 12v-6w (BOX 10 UNITS)	4596W	(*)

BULB



CHECK CONNECTIONS TURN SIGNALS ON PAGE 432. TO AVOID CONECTION PROBLEMS. CHECK THE TECHNICAL SHEET ON PAGE 431.



MINI

HOMOLOGATED

MODEL	REF.	PRICE
LED TURN SIGNAL CARBON LOOK BASE SHORT STEMP/ AMBER + SMOKE LENS + LASER LENS 75 x 37 mm. 12v 21w	4042C	(*)
JLED TURN SIGNAL CARBON LOOK BASE LONG STEMP/ AMBER + SMOKE LENS + LASER LENS 95 x 37 mm. 12v 21w	4043C	(*)
CLEAR BULB MINI TURN SIGNAL (BOX 10 UNITS) 12v-23w	1622W	(*)
AMBER BULB MINI TURN SIGNAL (BOX 10 UNITS) 12v 23w	1622T	(*)

BULB



CHECK CONNECTIONS TURN SIGNALS ON PAGE 432. TO AVOID CONECTION PROBLEMS. CHECK THE TECHNICAL SHEET ON PAGE 431.

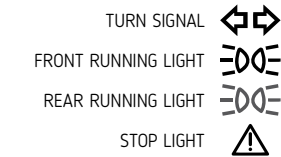

MASA

HOMOLOGATED

MODEL	REF.	PRICE
LED TURN SIGNAL CARBON LOOK BASE SHORT STEMP/ AMBER LENS + SMOKE LENS + LASER LENS BY PAIR 63 x 24 mm 12v 21w	4871N	(*)
AMBER BULB MASA TURN SIGNAL 12v-23w (BOX 10 UNITS)	1622T	(*)
CLEAR BULB MASA TURN SIGNAL 12v-23w (BOX 10 UNITS)	1622W	(*)
AMBER BULB MASA TURN SIGNAL 12v-6w (BOX 10 UNITS)	4596T	(*)
CLEAR BULB MASA TURN SIGNAL 12v-6w (BOX 10 UNITS)	4596W	(*)

CHECK CONNECTIONS TURN SIGNALS ON PAGE 432. TO AVOID CONECTION PROBLEMS. CHECK THE TECHNICAL SHEET ON PAGE 431.

TURN SIGNALS

HI-TECH PARTS | TECHNICAL SECTION



EYE

HOMOLOGATED

MODEL	REF.	N
BLACK BASE/ CLEAR LENS BY PAIR 58,7 x 21 mm. 12v 6w	6475N	(*)

BULB

- W Transparent
- T Orange

N Black

- TURN SIGNAL
- FRONT RUNNING LIGHT
- REAR RUNNING LIGHT
- STOP LIGHT



TIP

HOMOLOGATED

MODEL	REF.	N	T	W
BLACK BASE/ CLEAR LENS BY PAIR 67,4 x 29 mm. 12v 21w	6476N	(*)		
AMBER BULB TIP TURN SIGNAL 12v-23w (BOX 10 UNITS)	1622T	(*)		
CLEAR BULB TIP TURN SIGNAL 12v-23w (BOX 10 UNITS)	1622W	(*)		
AMBER BULB TIP TURN SIGNAL 12v-6w (BOX 10 UNITS)	4596T	(*)		
CLEAR BULB TIP TURN SIGNAL 12v-6w (BOX 10 UNITS)	4596W	(*)		

CHECK CONNECTIONS TURN SIGNALS ON PAGE 432.
TO AVOID CONNECTION PROBLEMS. CHECK THE TECHNICAL SHEET ON PAGE 431.

RESISTOR SET FOR LEDS TURN SIGNALS AND FLASHER RELAYS

HI-TECH PARTS | TECHNICAL SECTION

TECHNICAL INFO TURN SIGNALS CONNECTIONS:

Most of the bikes use bi-metallic relays. Its frequency (which is the one that sets the pace of the turn signals) depend on the amperage circulating through the circuit. When replacing the turn signals from OEM to aftermarket ones which carry a difference power, consequently they vary the amperage circulation through the circuit that causes a change on the frequency of the turn signals rhythm. If otherwise, the motorcycle uses electronic relay (which frequency works independently from the amperage circulating through the circuit) the change of turn signals from OEM to aftermarket, should not affect the frequency of the turn signals rhythm.

Note: In case of doubt of what type of relay the motorcycle uses, we recommend to check the turn signal rhythm after switching from OEM to aftermarket.

If the OEM turn signals are replaced by aftermarket ones that use incandescent bulbs, we need to check they use the same power. In case it is different, we need to replace the turn signals bulbs for others that use the same power as OEM ones. On our catalog, we have available bulbs of different power.

If the OEM turn signals are replaced by LED ones (of much less power than incandescent bulbs), we have two options to balance the frequency of rhythm:

1. Incorporate a parallel relay in the right circuit and the other on the left circuit. If we replace four turn signals, we need to use a resistance Part# 42980. If otherwise, only two turn signals are replaced (one on each side), we need to use a resistance Part# 42980. The resistances are supplied with a scheme for a parallel connection.

Note: On most of the bikes, the warning function of the bike is disabled if the resistance is used.

2. Identify the intermittent relay of the motorcycle (location and number of pins) and replace it for its corresponding from the list supplied on most of the bikes, the warning functions work correctly when the relay is replaced.

Note: we can find some motorcycles in the market that do not have an intermittent relay, obviously in this case it cannot be replaced. Moreover, if on the blinking function intervenes more than one relay, it is possible that replacing only one relay does not solve the problem.



MODEL	REF.	O	N	T
RESISTORS SET OF 3.9Ω 25w FOR LEDS TURN SIGNALS	42980		(*)	
RESISTORS SET OF 18Ω 25w FOR MOTORCYCLES THAT MOUNT REAR LEDS TURN SIGNALS, KEEPING ORIGINAL TURN SIGNALS	58730		(*)	
FLASHER RELAY 2 PINS	4823N		(*)	
FLASHER RELAY 3 PINS	4822N		(*)	
FLASHER RELAY 4 PINS	5180N		(*)	
FLASHER RELAY 7 PINS	3540N		(*)	
LED LAMP AMBER FOR TURN SIGNAL	1625T		(*)	

(*) Check price with your distributor.
IMPORTANT: Indicate code color after part#. Example 0973A.

CONNECTORS LEADS

HI-TECH PARTS | TYPE OF CONNECTORS LEADS:



REF. 3164 REF. 3703 REF. 3704 REF. 3846 REF. 3849 REF. 3850 REF. 3853

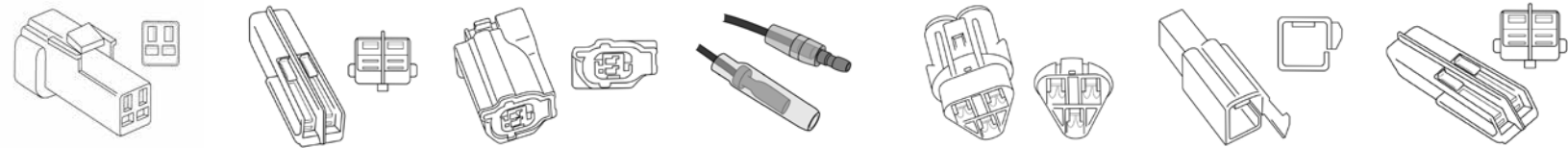

REF. 3871 REF. 3873 REF. 3888 REF. 3889 REF. 3890 REF. 3891 REF. 4854

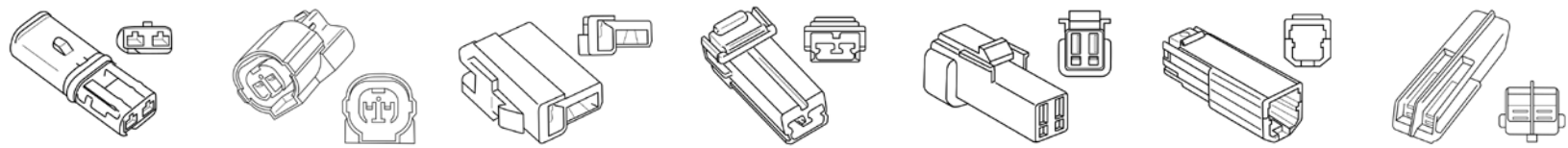

REF. 4856 REF. 4860 REF. 4863 REF. 4869 REF. 8510 REF. 9772 REF. 20312

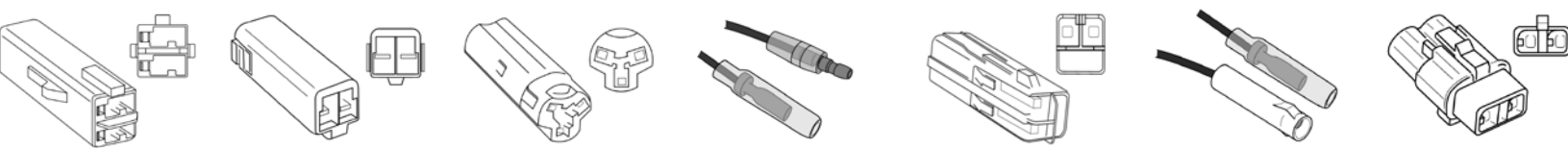

REF. 20545 REF. 20546 REF. 20547 REF. 20554 REF. 20566 REF. 20570 REF. 20587

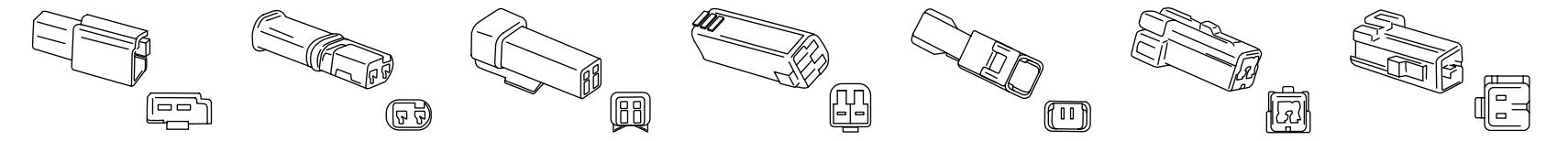

REF. 20588 REF. 20589 REF. 20590 REF. 20591 REF. 20627 REF. 20730

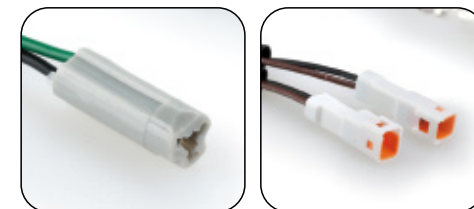
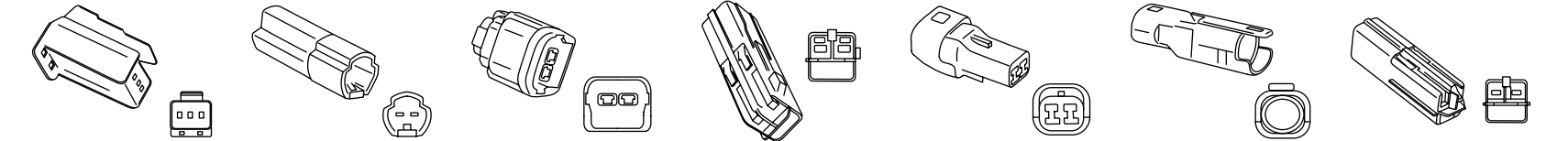

REF. 20731 REF. 20760

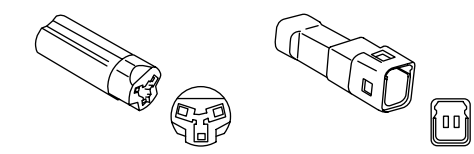

CONNECTORS LEADS

HI-TECH PARTS

MODEL	YEAR	FRONT TURN SIGNAL EXTENSION SET REF.	N	REAR TURN SIGNAL EXTENSION SET REF.	N	LICENSE LIGHT EXTENSION REF.	N
APRILIA							
RS 660	21'	20627N	(*)	20627N	(*)	20547N	(*)
TUONO 660	21'	20627N	(*)	20627N	(*)	20547N	(*)
BMW							
R1200R	05'-18'	3871N	(*)	3871N	(*)		
R1200RS	05'-18'	3871N	(*)	3871N	(*)		
R1250RS	19' - 21'	3871N	(*)	3871N	(*)		
R1250RS	19' - 21'	3871N	(*)	3871N	(*)		
S1000RR	19'					20546N	(*)
DUCATI							
PANIGALE V2	20'	3891N	(*)	3891N	(*)	20547N	(*)
PANIGALE 1100 V4	18'-21'	3891N	(*)	3891N	(*)	20547N	(*)
MONSTER 937	21'	3891N	(*)	3891N	(*)	20547N	(*)
MULTISTRADA V4	21'	20760N		20760N	(*)	20547N	(*)
HARLEY DAVIDSON							
HONDA							
CB300R NEO SPORTS CAFÉ	21'	4854N	(*)	4854N	(*)	3853N	(*)
CB500F	19' - 20'	4854N	(*)	4854N	(*)	3853N	(*)
CB650R NEO SPORT CAFÉ	19' - 21'			4854N	(*)	3853N	(*)
CB1000R NEO SPORTS CAFÉ	19' - 20'			4854N	(*)	3853N	(*)
CBR500R	19' - 20'	4854N	(*)	4854N	(*)	3853N	(*)
CBR650R	19' - 20'	20730N	(*)	4854N	(*)	3853N	(*)
CBR1000RR FIREBLADE	20'	20591N	(*)	20591N	(*)	20590N	(*)
CRF1100L AFRICA TWIN	20'	4854N	(*)	4854N	(*)	3853N	(*)
NC750X	21'			20791N	(*)	20590N	(*)
KAWASAKI							
NINJA 125	19' - 20'	4856N	(*)	4856N	(*)	3850N	(*)
NINJA 650	20'	3703N	(*)	3703N	(*)	3850N	(*)
NINJA 1000 SX	20'	3703N	(*)	3703N	(*)	20312N	(*)
VERSYS 650	15' - 19'	3703N	(*)	3703N	(*)	20312N	(*)
VERSYS 650	20'	3703N	(*)	3703N	(*)	3850N	(*)
VERSYS 1000	19' - 20'	3703N	(*)	3703N	(*)	20312N	(*)
Z125	19' - 20'	4856N	(*)	4856N	(*)	3850N	(*)
Z400	19' - 20'	4856N	(*)	4856N	(*)	3850N	(*)
Z650	20'	3703N	(*)	3703N	(*)	3850N	(*)
Z900	19'	4856N	(*)	4856N	(*)	3850N	(*)
Z900	20'	3703N	(*)	3703N	(*)	20312N	(*)
ZH2	20'	3703N	(*)	3703N	(*)	20312N	(*)
ZX-6R	19' - 20'	4856N	(*)	4856N	(*)	20312N	(*)
ZX-10R/RR	21'	3703N	(*)	3703N	(*)	20312N	(*)
KTM							
1290 SUPERDUKE R	18' - 19'	3890N	(*)	3890N	(*)	20566N	(*)

MODEL	YEAR	FRONT TURN SIGNAL EXTENSION SET REF.	N	REAR TURN SIGNAL EXTENSION SET REF.	N	LICENSE LIGHT EXTENSION REF.	N
1290 SUPERDUKE R	20'	3890N	(*)	3890N	(*)	20566N	(*)
MV AGUSTA							
SUZUKI							
SV650	18' - 20'	4863N	(*)	4863N	(*)	20554N	(*)
SV650X	18' - 20'	4863N	(*)	4863N	(*)	20554N	(*)
GSX-S125	20'	4869N	(*)	4869N	(*)	20547N	(*)
GSX-R125	20'	4869N	(*)	4869N	(*)	20547N	(*)
GSX-S750	19' - 20'	4860N	(*)	4860N	(*)	20554N	(*)
GSX-S1000	22'	3890N	(*)	3890N	(*)		
TRIUMPH							
STREET TRIPLE S	20'	9772N	(*)	9772N	(*)	20570N	(*)
STREET TRIPLE R / RS	20'	9772N	(*)	9772N	(*)	20570N	(*)
YAMAHA							
MT-125	15'-19'	20545N	(*)	20545N	(*)	20587N	(*)
MT-125	20'	4863N	(*)	4863N	(*)	3850N	(*)
MT-03	20'	3704N	(*)	3704N	(*)	20588N	(*)
MT-07	18' - 20'	4863N	(*)	4863N	(*)	20589N	(*)
MT-07	21'	3704N	(*)	4863N	(*)	20731N	(*)
MT-09	17' - 20'	4863N	(*)	4863N	(*)	20547N	(*)
MT-09	21'	3704N	(*)	3704N	(*)	20731N	(*)
MT-09 SP	21'	3704N	(*)	3704N	(*)	20731N	(*)
T-MAX 560	20'	3704N	(*)	3704N	(*)	3846N	(*)
TENERE 700	19' - 20'	4863N	(*)	4863N	(*)	20589N	(*)
MT-07 TRACER	20'	3704N	(*)	3704N	(*)	20589N	(*)
XSR 125	21'	4863N	(*)	4863N	(*)	3850N	(*)
YZF-R125	19' - 20'	4863N	(*)	4863N	(*)	3850N	(*)
YZF-R3	15' - 20'	4869N	(*)	4869N	(*)	3850N	(*)
YZF-R1	20'	3704N	(*)	3704N	(*)	20547N	(*)

NOTE: LENGTHS OF EXTENSIONS: 300 mm.

(#) Consult sketch.

(*) Check price with your distributor.

IMPORTANT: Indicate code color after part#. Example 0973A.

 N Black

INTEGRATED TURN SIGNALS

HI-TECH PARTS

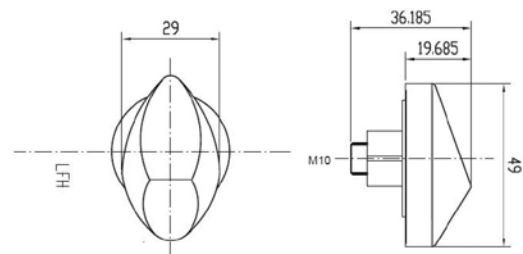

REF. 4487

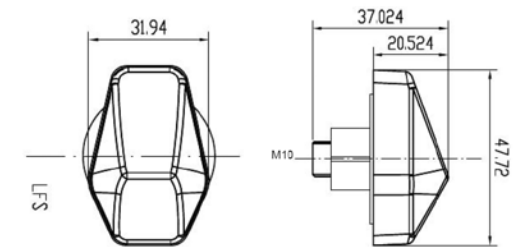

REF. 4488

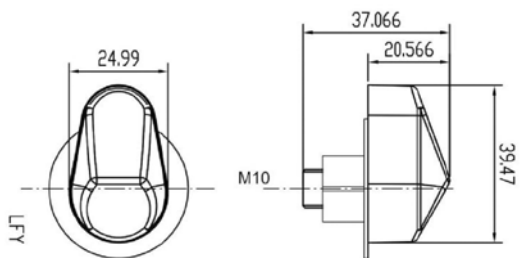

REF. 4489

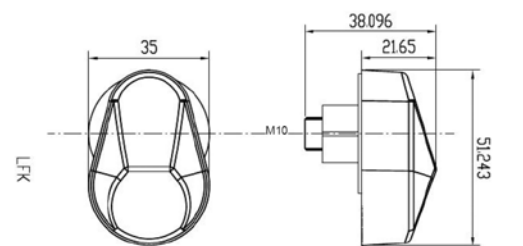

REF. 4490



TURN SIGNAL

HOMOLOGATED

REF. 4487K	12v 2w
REF. 4488K	12v 1w
REF. 4489K	12v 1w
REF. 4490K	12v 2w



2022 For the new 2022 motorcycle models check www.puig.tv

MODEL	YEAR	REF.	PRICE
HONDA			
CB500F/X	13' - 17'	4487K	(*)
CB600F HORNET	05' - 16'	4487K	(*)
CB650F	14' - 16'	4487K	(*)
CB900F HORNET	02' - 05'	4487K	(*)
CB1000R	08' - 16'	4487K	(*)
CBF1000F	10' - 16'	4487K	(*)
CBR500R	13' - 17'	4487K	(*)
CBR600F	99' - 07'	4487K	(*)
CBR600F	11' - 14'	4487K	(*)
CBR650F	14' - 16'	4487K	(*)
CBR600RR	03' - 16'	4487K	(*)
CBR900RR FIRE BLADE	98' - 03'	4487K	(*)
CBR1000RR	04' - 16'	4487K	(*)
CROSSRUNNER	11' - 17'	4487K	(*)
CROSSTOURER	14' - 17'	4487K	(*)
MSX125	14' - 17'	4487K	(*)
NC700S/X	12' - 13'	4487K	(*)
NC750S/X	14' - 17'	4487K	(*)
KAWASAKI			
VERSYS 650	07' - 09'	4490K	(*)
Z750	07' - 12'	4490K	(*)
Z750S	05' - 06'	4490K	(*)
ZR7S	01' - 03'	4490K	(*)
ZRX1200S	01' - 07'	4490K	(*)
ZX-6R	94' - 04'	4490K	(*)
ZX-9R	94' - 04'	4490K	(*)
ZX-10R	04' - 05'	4490K	(*)
ZX-12R	00' - 06'	4490K	(*)
SUZUKI			
DL650A V-STROM	12' - 16'	4488K	(*)
DL650XT V-STROM	15' - 16'	4488K	(*)
DL1000 V-STROM	14' - 16'	4488K	(*)
GSF600 BANDIT	00' - 04'	4488K	(*)
GSF650 BANDIT	05' - 11'	4488K	(*)
GSF650S BANDIT	05' - 14'	4488K	(*)

2022 For the new 2022 motorcycle models check www.puig.tv

MODEL	YEAR	REF.	PRICE
GSF1200 BANDIT	01' - 06'	4488K	(*)
GSF1250S BANDIT	07' - 13'	4488K	(*)
GSR750	11' - 16'	4488K	(*)
GSX650F	08' - 17'	4488K	(*)
GSX1250F	10' - 17'	4488K	(*)
GSX-R600/750	01' - 05'	4488K	(*)
GSX-R1000	01' - 04'	4488K	(*)
GSX-S1000	15' - 17'	4488K	(*)
GSX-S1000F	15' - 17'	4488K	(*)
SFV650 GLADIUS	09' - 15'	4488K	(*)
SV650S	03' - 08'	4488K	(*)
YAMAHA			
FAZER8	13' - 16'	4489K	(*)
FZ1/FAZER	06' - 15'	4489K	(*)
FZ6/FAZER	04' - 08'	4489K	(*)
FZ8/FAZER		4489K	(*)
MT-07	14' - 17'	4489K	(*)
MT-09	13' - 16'	4489K	(*)
MT-09 TRACER	15' - 17'	4489K	(*)
TDM900	02' - 13'	4489K	(*)
XJ6/DIVERSION/F		4489K	(*)
XSR700	16' - 18'	4489K	(*)
YZF-R1	02' - 14'	4489K	(*)
YZF-R3	15' - 17'	4489K	(*)
YZF-R6	03' - 16'	4489K	(*)

Technical characteristics: 12v 0,5w

TO AVOID CONECTION PROBLEMS. CHECK THE TECHNICAL SHEET ON PAGE 431.

(*) Check price with your distributor.
IMPORTANT: Indicate code color after part#. Example 0973A.

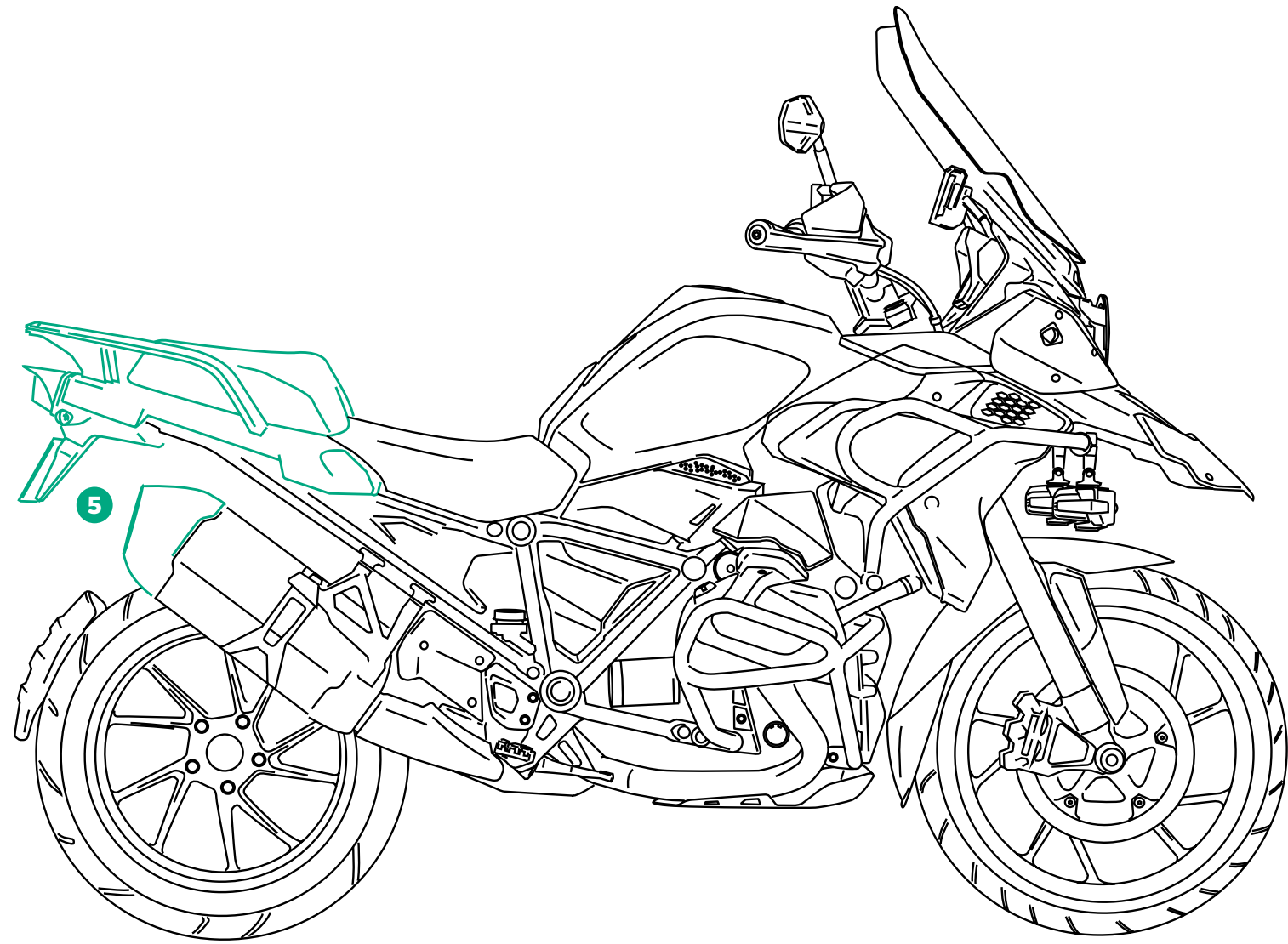

REAR AREA

END TUBE FOR EXHAUST	457
LICENSE SUPPORTS	441
LIGHTING LICENSE SUPPORT	448
SUPPORT FOR ORIGINAL TURN SIGNAL	451
TAIL LIGHTS	454



LICENSE SUPPORTS

HI-TECH PARTS | TECHNICAL SECTION

KIT

It is supplied with light and reflector, both homologated. According to models.



ADJUSTABLE

Fixed or adjustable on inclination.

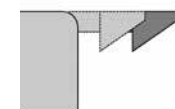

TURN SIGNALS

Adjustable lodge for turn signals.

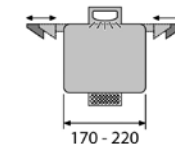

UNIVERSAL

Most suitable for license plates.

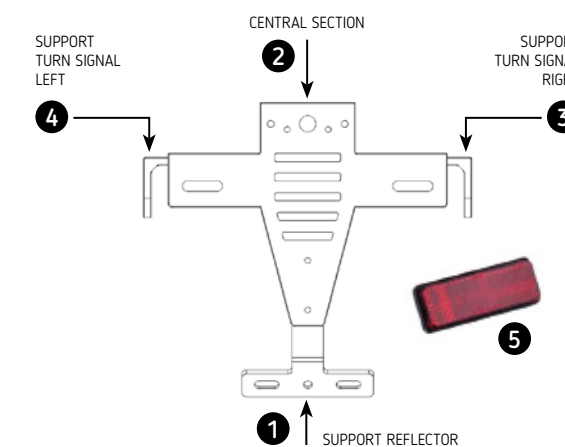

The license support is not designed to mount the oem turn signals. Oem connectors are not delivered to connect lighting license.

■ R Red
■ N Black

■ I Stainless Steel



REF. 9353N

SPARES	REF.	N	R	I
METALLIC SUPPORT TO MOVE THE CATADIOPTRIC (1)	4480I		*	
NYLON SUPPORT TO DISPLACE THE CATADIOPTRIC (1)	1553N		*	
NYLON SUPPORT FOR LICENSE PLATE (2)	1558N		*	
NYLON SUPPORT FOR TURN SIGNAL RIGHT (3)	1559N		*	
NYLON SUPPORT FOR TURN SIGNAL LEFT (4)	1615N		*	
CATADIOPTRIC HOMOLOGATED DE 8,8 x 3,4 cm. C/RED (5)	4481R		*	
CATADIOPTRIC HOMOLOGATED DE 7,5 x 2,5 cm. C/RED (5)	5729R		*	

LIGHTING LICENSE SUPPORTS SEE PAGE 448.
 TURN SIGNALS FOR LICENSE PLATE HOLDER SEE PAGE 413.

UNIVERSAL MODELS	ADJUSTABLE	T. SIGNAL SUPPORT	INCLUDE KIT	REF.	N
UNIVERSAL	YES/NO	YES ADJUST.	NO	1539N	*

FOR SPECIFIC MODELS SEE PAGE 442.

(*) Check price with your distributor.
 IMPORTANT: Indicate code color after part#. Example 0973A.

LICENSE SUPPORTS

HI-TECH PARTS

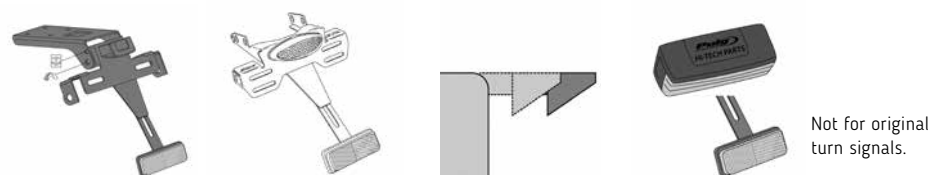

2022		For the new 2022 motorcycle models check www.puig.tv					
MODEL	YEAR	ADJUSTABLE	BRAKE REAR LIGHT- INCLUDED	TURN LIGHT SUPPORT	INCLUDE KIT	REF.	N
APRILIA							
RS 660	21'	YES/NO (&)	NO	YES ADJUST.	YES	20605	(*)
RSV4	09' - 12'	YES/NO (&)	NO	YES ADJUST.	YES	4978	(*)
RSV4 FACTORY	13' - 14'	YES/NO (&)	NO	YES ADJUST.	YES	4978	(*)
RSV4 RF	15' - 20'	YES/NO (&)	NO	YES ADJUST.	YES	4978	(*)
RSV4 RR	15' - 20'	YES/NO (&)	NO	YES ADJUST.	YES	4978	(*)
TUONO 660	21'	YES/NO (&)	NO	YES ADJUST.	YES	20605	(*)
TUONO V4R	11' - 14'	YES/NO (&)	NO	YES ADJUST.	YES	4978	(*)
TUONO V4 1100 RR	15' - 21'	YES/NO (&)	NO	YES ADJUST.	YES	4978	(*)
TUONO V4 1100 FACTORY	15' - 20'	YES/NO (&)	NO	YES ADJUST.	YES	4978	(*)
BENELLI							
BN 125	18' - 21'	YES/NO (&)	NO	YES ADJUST.	YES	20524	(*)
BMW							
C600 SPORT	12' - 15'	YES/NO (&)	NO	YES ADJUST.	YES	6061	(*)
C650 SPORT	16' - 20'	YES/NO (&)	NO	YES ADJUST.	YES	6061	(*)
R1200 R	15' - 18'	YES/NO (&)	NO	YES ADJUST.	NO	8541	(*)
R1200 RS	15' - 18'	YES/NO (&)	NO	YES ADJUST.	NO	8541	(*)
R1250 R	19' - 21'	YES/NO (&)	NO	YES ADJUST.	NO	8541	(*)
R1250 RS	19' - 21'	YES/NO (&)	NO	YES ADJUST.	NO	8541	(*)
S1000 R	14' - 20'	YES/NO (&)	NO	YES ADJUST.	YES	5319	(*)
S1000 R	21'	YES/NO (&)	NO	YES ADJUST.	YES	3705	(*)
S1000RR	09' - 11'	YES/NO (&)	NO	YES ADJUST.	YES	5319	(*)
S1000RR	12' - 18'	YES/NO (&)	NO	YES ADJUST.	YES	5319	(*)
S1000RR	19' - 21'	YES/NO (&)	NO	YES ADJUST.	YES	3705	(*)
DUCATI							
PANIGALE V2	20' - 21'	YES/NO (&)	NO	YES ADJUST.	YES	9751	(*)
PANIGALE V2 BAYLISS	21'	YES/NO (&)	NO	YES ADJUST.	YES	9751	(*)
PANIGALE 1100 V4	18' - 21'	YES/NO (&)	NO	YES ADJUST.	YES	9751	(*)
PANIGALE 1100 V4 SP	21'	YES/NO (&)	NO	YES ADJUST.	YES	9751	(*)
PANIGALE 1100 V4S	18' - 21'	YES/NO (&)	NO	YES ADJUST.	YES	9751	(*)
MONSTER 620	02' - 06'	NO	NO	NO	NO	1771	(*)
MONSTER 695	06' - 07'	NO	NO	NO	NO	1771	(*)
MONSTER 696	08' - 14'	YES/NO (&)	NO	YES	YES	4733	(*)
MONSTER 796	10' - 14'	YES/NO (&)	NO	YES	YES	4979	(*)
MONSTER 797	17' - 20'	YES/NO (&)	NO	YES	YES	9496	(*)
MONSTER 800	03' - 04'	NO	NO	NO	NO	1771	(*)
MONSTER 821	18' - 20'	YES/NO (&)	NO	YES ADJUST.	YES	9496	(*)

2022		For the new 2022 motorcycle models check www.puig.tv					
MODEL	YEAR	ADJUSTABLE	BRAKE REAR LIGHT- INCLUDED	TURN LIGHT SUPPORT	INCLUDE KIT	REF.	N
MONSTER 937	21'	YES/NO (&)	NO	YES ADJUST.	YES	20715	(*)
MONSTER 937 PLUS	21'	YES/NO (&)	NO	YES ADJUST.	YES	20715	(*)
MONSTER 1000/S	03' - 05'	NO	NO	NO	NO	1771	(*)
MONSTER 1100/S	09' - 10'	YES/NO (&)	NO	YES	YES	4979	(*)
MONSTER 1100 EVO	11' - 13'	YES/NO (&)	NO	YES	YES	4979	(*)
MONSTER 1200/S	17' - 21'	YES/NO (&)	NO	YES ADJUST.	YES	9496	(*)
MONSTER S2R	05' - 07'	NO	NO	NO	NO	1771	(*)
MONSTER S4R	04' - 06'	NO	NO	NO	NO	1771	(*)
STREETFIGHTER V4/S	20' - 21'	YES/NO (&)	NO	YES ADJUST.	YES	9751	(*)
SUPERSPORT 939/S	17' - 20'	YES/NO (&)	NO	YES ADJUST.	YES	9496	(*)
SUPERSPORT 950/S	21'	YES/NO (&)	NO	YES ADJUST.	YES	9496	(*)
HARLEY DAVIDSON							
SPORTSTER 883 IRON	13' - 20'	NO	NO	NO	YES	9994	(*)
HONDA							
CB125R NEO SPORTS CAFE	18' - 21'	YES/NO (&)	NO	YES ADJUST.	YES	9653	(*)
CB300R NEO SPORTS CAFE	18' - 21'	YES/NO (&)	NO	YES ADJUST.	YES	9653	(*)
CB500F	16' - 21'	YES/NO (&)	NO	YES ADJUST.	YES	8722	(*)
CB650F	14' - 16'	YES/NO (&)	NO	YES ADJUST.	YES	7100	(*)
CB650F	17' - 20'	YES/NO (&)	NO	YES ADJUST.	YES	7100	(*)
CB1000R	08' - 16'	YES/NO (&)	NO	YES ADJUST.	NO	4732	(*)
CB650R NEO SPORTS CAFE	19' - 20'	YES/NO (&)	NO	YES ADJUST.	YES	3527	(*)
CB650R NEO SPORTS CAFE	21'	YES/NO (&)	NO	YES ADJUST.	YES	20565	(*)
CBR500R	16' - 21'	YES/NO (&)	NO	YES ADJUST.	YES	8722	(*)
CBR650R	19' - 20'	YES/NO (&)	NO	YES ADJUST.	YES	3527	(*)
CBR650R	21'	YES/NO (&)	NO	YES ADJUST.	YES	20565	(*)
CBR600RR	03' - 06'	NO	NO	YES	NO	1612	(*)
CBR600RR	07' - 12'	NO	YES	YES	NO	4453	(*)
CBR600RR	13' - 16'	NO	NO	YES	YES	6545	(*)
CBR1000RR FIREBLADE	04' - 07'	NO	NO	YES	YES - ONLY CATADIOPTRIC	1766	(*)
CBR1000RR FIREBLADE/SP/SP2	17' - 19'	YES/NO (&)	NO	YES ADJUST.	YES	9456	(*)
CBR1000RR FIREBLADE/SP	20' - 21'	YES/NO (&)	NO	YES ADJUST.	YES	20489	(*)
CRF1100L AFRICA TWIN	20'	YES/NO (&)	NO	YES ADJUST.	YES	3842	(*)
CRF1100L AFRICA TWIN ADVENTURE SPORTS	20'	YES/NO (&)	NO	YES ADJUST.	YES	3842	(*)
CMX 500 REBEL	17' - 21'	NO	YES	NO	YES - ONLY CATADIOPTRIC	9671	(*)
CMX 500 REBEL	20' - 21'	NO	YES	NO	YES - ONLY CATADIOPTRIC	9671	(*)
INTEGRA 750	16' - 21'	YES/NO (&)	NO	YES ADJUST.	YES	8725	(*)
INTEGRA 750S	16' - 19'	YES/NO (&)	NO	YES ADJUST.	YES	8725	(*)
MONKEY 125	18' - 21'	YES/NO (&)	NO	YES ADJUST.	YES	20550	(*)

(&) Produced not adjustable with a removable fastener.
 (-) It's necessary to cut the rear fender.
 (***) Required original piece from Yamaha ref. 15D-F1685-10.
 (*) Check price with your distributor.
 IMPORTANT: Indicate code color after part#. Example 0973A.



LICENSE SUPPORTS

HI-TECH PARTS

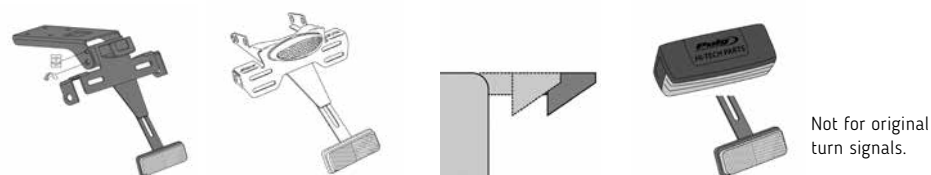

2022		For the new 2022 motorcycle models check www.puig.tv						
MODEL	YEAR	ADJUSTABLE	BRAKE REAR LIGHT- INCLUDED	TURN LIGHT SUPPORT	INCLUDE KIT	REF.	N	
MSX125	14' - 15'	YES/NO (&)	NO	YES ADJUST.	YES	7552	(*)	
MSX125	16' - 20'	YES/NO (&)	NO	YES ADJUST.	YES	9257	(*)	
NC750S/X	16' - 20'	YES/NO (&)	NO	YES ADJUST.	YES	8725	(*)	
NC750S	21'	YES/NO (&)	NO	YES ADJUST.	YES	8725	(*)	
NC750X	21'	YES/NO (&)	NO	YES ADJUST.	YES	20742	(*)	
X-ADV	17' - 20'	YES/NO (&)	YES	YES ADJUST.	YES	9706	(*)	
KAWASAKI								
ER-6N	12' - 16'	YES/NO (&)	NO	YES ADJUST.	YES	6096	(*)	
ER-6F	12' - 16'	YES/NO (&)	NO	YES ADJUST.	YES	6096	(*)	
NINJA 125	19' - 21'	YES/NO (&)	NO	YES ADJUST.	YES	7788	(*)	
NINJA 250SL	15' - 16'	YES/NO (&)	NO	YES ADJUST.	YES	7788	(*)	
NINJA 400	18' - 21'	YES/NO (&)	NO	YES ADJUST.	YES	9629	(*)	
NINJA 650	17' - 21'	YES/NO (&)	NO	YES ADJUST.	YES	9353	(*)	
NINJA 1000SX	20' - 21'	YES/NO (&)	NO	YES ADJUST.	YES	5735	(*)	
NINJA H2 SX	18' - 21'	YES/NO (&)	NO	YES ADJUST.	YES	9707	(*)	
VERSYS-X 300	17' - 20'	YES/NO (&)	NO	YES ADJUST.	YES	9475	(*)	
VERSYS 650	10' - 14'	YES/NO (&)	NO	YES ADJUST.	YES	5318	(*)	
VERSYS 650	15' - 21'	YES/NO (&)	NO	YES ADJUST.	YES	7789	(*)	
VERSYS 1000	17' - 18'	YES/NO (&)	NO	YES ADJUST.	YES	9450	(*)	
VULCAN S	15' - 21'	NO	YES	NO	YES	9675	(*)	
VULCAN S CAFE	17' - 20'	NO	YES	NO	YES	9675	(*)	
Z125	19' - 21'	YES/NO (&)	YES	YES ADJUST.	YES	7788	(*)	
Z250SL	15' - 16'	YES/NO (&)	NO	YES ADJUST.	YES	7788	(*)	
Z400	19' - 21'	YES/NO (&)	NO	YES ADJUST.	YES	9629	(*)	
Z650	17' - 21'	YES/NO (&)	NO	YES ADJUST.	YES	9353	(*)	
Z750	04' - 06'	NO	NO	YES	NO	1607	(*)	
Z750	07' - 12'	NO	NO	YES	YES	4529	(*)	
Z750S	05' - 06'	NO	NO	YES	NO	1607	(*)	
Z750R	11' - 12'	NO	NO	YES	YES	4529	(*)	
Z800	13' - 16'	YES/NO (&)	NO	YES ADJUST.	YES	6548	(*)	
Z800E	13' - 16'	YES/NO (&)	NO	YES ADJUST.	YES	6548	(*)	
Z900	17' - 21'	YES/NO (&)	NO	YES ADJUST.	YES	9388	(*)	
Z900RS	18' - 21'	YES/NO (&)	NO	YES ADJUST.	YES	9597	(*)	
Z900RS CAFÉ	18' - 21'	YES/NO (&)	NO	YES ADJUST.	YES	9597	(*)	
Z1000	03' - 06'	NO	NO	YES	NO	1607	(*)	
Z1000	07' - 09'	NO	NO	YES	YES	4529	(*)	
Z1000	14' - 21'	YES/NO (&)	NO	YES ADJUST.	YES	7102	(*)	

2022		For the new 2022 motorcycle models check www.puig.tv						
MODEL	YEAR	ADJUSTABLE	BRAKE REAR LIGHT- INCLUDED	TURN LIGHT SUPPORT	INCLUDE KIT	REF.	N	
Z1000R	17' - 21'	YES/NO (&)	NO	YES ADJUST.	YES	7102	(*)	
Z1000SX	11' - 16'	YES/NO (&)	NO	YES ADJUST.	YES	5735	(*)	
Z1000SX	17' - 19'	YES/NO (&)	NO	YES ADJUST.	YES	5735	(*)	
ZH2	20' - 21'	YES/NO (&)	NO	YES ADJUST.	YES	20510	(*)	
Z H2 SE	20' - 21'	YES/NO (&)	NO	YES ADJUST.	YES	20510	(*)	
ZX-6R	03' - 04'	NO	NO	YES	NO	1607	(*)	
ZX-6R	18' - 21'	YES/NO (&)	NO	YES ADJUST.	YES	3180	(*)	
ZX-10R	16' - 20'	YES/NO (&)	NO	YES ADJUST.	YES	8726	(*)	
ZX-10R	21'	YES/NO (&)	NO	YES ADJUST.	YES	20535	(*)	
ZX-10RR	17' - 20'	YES/NO (&)	NO	YES ADJUST.	YES	8726	(*)	
ZX-10RR	21'	YES/NO (&)	NO	YES ADJUST.	YES	20535	(*)	
ZX-10R SE	18' - 20'	YES/NO (&)	NO	YES ADJUST.	YES	8726	(*)	
KTM								
125 DUKE	17' - 21'	YES/NO (&)	NO	YES ADJUST.	YES	9492	(*)	
390 DUKE	17' - 21'	YES/NO (&)	NO	YES ADJUST.	YES	9492	(*)	
790 DUKE	18' - 21'	YES/NO (&)	YES	YES ADJUST.	YES	9683	(*)	
890 DUKE R	20' - 21'	YES/NO (&)	YES	YES ADJUST.	YES	9683	(*)	
1290 SUPERDUKE R	14' - 16'	YES/NO (&)	NO	YES ADJUST.	YES	7106	(*)	
1290 SUPERDUKE R	17' - 19'	YES/NO (&)	NO	YES ADJUST.	YES	7106	(*)	
1290 SUPERDUKE R	20' - 21'	YES/NO (&)	NO	YES ADJUST.	YES	20449	(*)	
1290 SUPERDUKE GT	16' - 21'	YES/NO (&)	NO	YES ADJUST.	YES	8728	(*)	
RC125/390	14' - 21'	YES/NO (&)	NO	YES ADJUST.	YES	7107	(*)	
KYMCO								
AK550	17' - 21'	YES/NO (&)	NO	NO	YES	9534	(*)	
MV AGUSTA								
BRUTALE 990 RR	10' - 13'	YES/NO (&)	NO	YES ADJUST.	YES	5738	(*)	
BRUTALE 1090 RR	10' - 18'	YES/NO (&)	NO	YES ADJUST.	YES	5738	(*)	
SUZUKI								
DL650 V-STROM	04' - 11'	YES/NO (&)	NO	NO	YES	6272	(*)	
DL650 V-STROM	12' - 16'	YES/NO (&)	NO	YES	YES	6372	(*)	
DL650XT V-STROM	15' - 16'	YES/NO (&)	NO	YES	YES	6372	(*)	
GSR600 (-)	06' - 11'	NO	NO	YES	YES	4076	(*)	
GSR750	11' - 16'	YES/NO (&)	NO	YES ADJUST.	YES	5734	(*)	
GSX-S125	17' - 21'	YES/NO (&)	NO	YES ADJUST.	YES	9958	(*)	
GSX-S750	17' - 21'	YES/NO (&)	NO	YES ADJUST.	YES	9422	(*)	
GSX-S950	22'	YES/NO (&)	NO	YES ADJUST.	YES	9422	(*)	
GSX-S1000	15' - 22'	YES/NO (&)	NO	YES ADJUST.	YES	9422	(*)	
GSX-S1000F	15' - 21'	YES/NO (&)	NO	YES ADJUST.	YES	9422	(*)	
GSX-R125	17' - 21'	YES/NO (&)	NO	YES ADJUST.	YES	9958	(*)	
GSX-R250	17' - 21'	YES/NO (&)	NO	YES ADJUST.	YES	9523	(*)	
GSX-R600	04' - 05'	NO	NO	YES	YES	1779	(*)	

N Black

(&) Produced not adjustable with a removable fastener.
 (-) It's necessary to cut the rear fender.
 (**) Required original piece from Yamaha ref. 15D-F1685-10.
 (*) Check price with your distributor.
 IMPORTANT: Indicate code color after part#. Example 0973A.

LICENSE SUPPORTS

HI-TECH PARTS

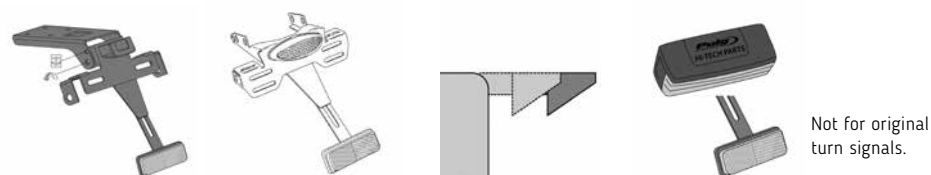

2022		For the new 2022 motorcycle models check www.puig.tv					
MODEL	YEAR	ADJUSTABLE	BRAKE REAR LIGHT- INCLUDED	TURN LIGHT SUPPORT	INCLUDE KIT	REF.	N
GSX-R600	06' - 07'	YES/NO (&)	NO	NO	NO	4075	(*)
GSX-R600	08' - 10'	YES/NO (&)	NO	NO	YES	4735	(*)
GSX-R600	11' - 16	YES/NO (&)	NO	NO	YES	5733	(*)
GSX-R750	04' - 05'	NO	NO	YES	YES	1779	(*)
GSX-R750	06' - 07'	YES/NO (&)	NO	NO	NO	4075	(*)
GSX-R750	08' - 10'	YES/NO (&)	NO	NO	YES	4735	(*)
GSX-R750	11' - 16'	YES/NO (&)	NO	NO	YES	5733	(*)
GSX-R1000/R	17' - 20'	YES/NO (&)	NO	YES ADJUST.	YES	9451	(*)
GSXR1300 HAYABUSA	08' - 12'	YES/NO (&)	NO	NO	YES	4817	(*)
KATANA	19' - 21'	YES/NO (&)	NO	YES	YES	3647	(*)
SV650	16' - 21'	YES/NO (&)	NO	YES ADJUST.	YES	8729	(*)
SV650X	18' - 21'	YES/NO (&)	NO	YES ADJUST.	YES	8729	(*)
TRIUMPH							
DAYTONA 675/R	13' - 17'	YES/NO (&)	NO	YES ADJUST.	YES	6551	(*)
SPEED TRIPLE	11' - 15'	YES/NO (&)	NO	YES	YES	5732	(*)
SPEED TRIPLE R	12' - 15'	YES/NO (&)	NO	YES	YES	5732	(*)
SPEED TRIPLE/R	16' - 19'	YES/NO (&)	NO	NO	YES	8730	(*)
STREET TRIPLE/R	13' - 19'	YES/NO (&)	NO	YES ADJUST.	YES	6551	(*)
STREET TRIPLE R	20' - 21'	YES/NO (&)	NO	YES ADJUST.	YES	6551	(*)
STREET TRIPLE S	17' - 21'	YES/NO (&)	NO	YES ADJUST.	YES	6551	(*)
STREET TRIPLE RS	17' - 21'	YES/NO (&)	NO	YES ADJUST.	YES	6551	(*)
YAMAHA							
FZ6	04' - 08'	YES/NO (&)	NO	YES ADJUST.	NO	5046	(*)
FZ6 FAZER	04' - 08'	YES/NO (&)	NO	YES ADJUST.	NO	5046	(*)
FZ6 FAZER S2	07' - 10'	YES/NO (&)	NO	YES ADJUST.	NO	5046	(*)
FZ6 S2	07' - 10'	YES/NO (&)	NO	YES ADJUST.	NO	5046	(*)
MT-125	15' - 19'	YES/NO (&)	NO	YES ADJUST.	YES	7796	(*)
MT-125	20' - 21'	YES/NO (&)	NO	YES ADJUST.	YES	3884	(*)
MT-03	16' - 21'	YES/NO (&)	NO	YES ADJUST.	YES	7799	(*)
MT-07	14' - 21'	YES/NO (&)	NO	YES ADJUST.	YES	7108	(*)
MT-07 TRACER	16' - 19'	YES/NO (&)	NO	YES ADJUST.	YES	9204	(*)
MT-07 TRACER	20' - 21'	YES/NO (&)	NO	YES ADJUST.	YES	9204	(*)
MT-07 TRACER GT	20' - 21'	YES/NO (&)	NO	YES ADJUST.	YES	9204	(*)
MT-09	13' - 16'	YES/NO (&)	NO	YES ADJUST.	YES	6885	(*)
MT-09	17' - 20'	YES/NO (&)	NO	YES ADJUST.	YES	9379	(*)
MT-09	17' - 20'	NO	NO	NO	YES	9394	(*)
MT-09	21'	YES/NO (&)	NO	YES ADJUST.	YES	20668	(*)

2022		For the new 2022 motorcycle models check www.puig.tv					
MODEL	YEAR	ADJUSTABLE	BRAKE REAR LIGHT- INCLUDED	TURN LIGHT SUPPORT	INCLUDE KIT	REF.	N
MT-09 SP	18' - 20'	YES/NO (&)	NO	YES ADJUST.	YES	9379	(*)
MT-09 SP	21'	YES/NO (&)	NO	YES ADJUST.	YES	20668	(*)
MT-09 TRACER	15' - 20'	YES/NO (&)	NO	YES ADJUST.	YES	6885	(*)
MT-09 TRACER	21'	YES/NO (&)	NO	YES ADJUST.	YES	20836	(*)
TENERE 700	19' - 21'	YES/NO (&)	NO	YES ADJUST.	YES	3861	(*)
T-MAX 500 (-)	08' - 11'	YES/NO (&)	NO	NO	YES	4852	(*)
T-MAX 530	12' - 16'	YES/NO (&)	NO	NO	YES	6092	(*)
T-MAX 530/DX/SX	17' - 19'	YES/NO (&)	NO	YES ADJUST.	YES	9468	(*)
T-MAX 560 /SX/DX/MAX TECH	20' - 21'	YES/NO (&)	NO	YES ADJUST.	YES	3874	(*)
XJ6	09' - 16'	YES/NO (&)	NO	YES ADJUST.	YES	4949	(*)
XJ6 DIVERSION	09' - 16'	YES/NO (&)	NO	YES ADJUST.	YES	4949	(*)
XJ6 DIVERSION F	10' - 16'	YES/NO (&)	NO	YES ADJUST.	YES	4949	(*)
X-MAX 125 (**)	14' - 17'	YES/NO (&)	NO	NO	YES	6993	(*)
X-MAX 250 (**)	14' - 16'	YES/NO (&)	NO	NO	YES	6993	(*)
X-MAX 400 (**)	13' - 17'	YES/NO (&)	NO	NO	YES	6993	(*)
XSR 125	21'	YES/NO (&)	NO	YES ADJUST.	YES	20282	(*)
XSR700	16' - 21'	YES/NO (&)	YES	YES ADJUST.	YES	8733	(*)
XSR700 XTRIBUTE	19' - 21'	YES/NO (&)	YES	YES ADJUST.	YES	8733	(*)
YZF-R125	19' - 21'	YES/NO (&)	NO	YES ADJUST.	YES	3620	(*)
YZF-R1	02' - 03'	YES/NO (&)	NO	YES	YES	1611	(*)
YZF-R1/SP	04' - 06'	NO	NO	YES	NO	1762	(*)
YZF-R1	07' - 08'	YES/NO (&)	NO	YES	NO	4454	(*)
YZF-R1	15' - 21'	YES/NO (&)	NO	YES ADJUST.	YES	7798	(*)
YZF-R1M	17' - 21'	YES/NO (&)	NO	YES ADJUST.	YES	7798	(*)
YZF-R3	15' - 21'	YES/NO (&)	NO	YES ADJUST.	YES	7799	(*)
YZF-R6	03' - 05'	YES/NO (&)	NO	YES	YES	1611	(*)
YZF-R6	06' - 07'	YES/NO (&)	NO	YES	YES	4073	(*)
YZF-R6	17' - 20'	YES/NO (&)	NO	YES ADJUST.	NO	9842	(*)



(&) Produced not adjustable with a removable fastener.
 (-) It's necessary to cut the rear fender.
 (***) Required original piece from Yamaha ref. 15D-F1685-10.
 (*) Check price with your distributor.
 IMPORTANT: Indicate code color after part#. Example 0973A.



ANGLE

HOMOLOGATED

NEW!

MODEL	REF.	N
LICENSE LIGHT SUPPORT MODEL ANGLE (48 x 19 mm.)	20768N	(*)

MADE IN BLACK PLASTIC SUITABLE FOR OUR LICENCE SUPPORTS.

PLA

HOMOLOGATED

MODEL	REF.	N
LICENSE LIGHT SUPPORT MODEL PLA WITH LEDES (45 x 20 mm.)	5577N	(*)

MADE IN BLACK PLASTIC SUITABLE FOR OUR LICENCE SUPPORTS.

ALU

HOMOLOGATED

MODEL	REF.	N
LICENSE LIGHT SUPPORT MODEL ALU WITH LEDES (45 x 20 mm.)	5565N	(*)

MADE IN ALUMINIUM ANODIZED SUITABLE FOR OUR LICENCE SUPPORTS.

 N Black

(*) Check price with your distributor.
IMPORTANT: Indicate code color after part#. Example 0973A.



MIG

HOMOLOGATED

MODEL	REF.	N
LICENSE LIGHT SUPPORT MODEL MIG WITH LEDES (56 x 26 mm.)	4646N	(*)
LICENSE LIGHT SUPPORT MODEL MIG WITH LEDES (56 x 26 mm.)	3736N	(*)

MADE IN BLACK PLASTIC SUITABLE FOR OUR LICENCE SUPPORTS.

 N Black

(*) Check price with your distributor.
IMPORTANT: Indicate code color after part#. Example 0973A.



TRO

HOMOLOGATED

MODEL	REF.	N
LICENSE LIGHT SUPPORT MODEL TRO WITH LEDES (56 x 26 mm.)	4645	(*)

MADE IN ALUMINIUM ANODIZED SUITABLE FOR OUR LICENCE SUPPORTS.



SUPPORT FOR ORIGINAL TURN SIGNAL

HI-TECH PARTS | TECHNICAL SECTION

FUNCTION

They allow the assembly of the original turn signals in the PUIG license plate holders.



MATERIAL

Made of steel.
Finished with epoxy black paint.

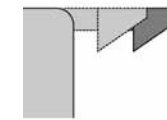

OPTICS

Hides the empty section left by the original turn signal once replaced.



REF. 9320N

 N Black

FOR SPECIFIC MODELS SEE PAGE 452.

SUPPORT FOR ORIGINAL TURN SIGNAL

HI-TECH PARTS

2022 For the new 2022 motorcycle models check www.puig.tv				
MODEL	YEAR	REF.	N	
APRILIA				
RS 660	21'	3585N	(*)	
RSV4	09' - 12'	3585N	(*)	
RSV4 FACTORY	13' - 14'	3585N	(*)	
RSV4 RF	15' - 20'	3585N	(*)	
RSV4 RR	15' - 20'	3585N	(*)	
TUONO 660	21'	3585N	(*)	
TUONO V4R	11' - 14'	3585N	(*)	
TUONO V4RR	15' - 21'	3585N	(*)	
TUONO V4 1100 FACTORY	15' - 20'	3585N	(*)	
BMW				
C600 SPORT	12' - 15'	3585N	(*)	
C650 SPORT	16' - 20'	3585N	(*)	
S1000 R	14' - 20'	3585N	(*)	
S1000RR	09' - 18'	3585N	(*)	
DERBI				
GPR 125	09' - 14'	3585N	(*)	
DUCATI				
MONSTER 797	17' - 20'	9604N	(*)	
MONSTER 821	18' - 20'	9604N	(*)	
MONSTER 937	21'	9604N	(*)	
MONSTER 937 PLUS	21'	9604N	(*)	
MONSTER 1200/S	17' - 21'	9604N	(*)	
PANIGALE V2	20' - 21'	9604N	(*)	
PANIGALE V2 BAYLISS	21'	9604N	(*)	
PANIGALE 1100 V4	18' - 19'	9604N	(*)	
PANIGALE 1100 V4S	18' - 19'	9604N	(*)	
SUPERSPORT 939/S	17' - 20'	9604N	(*)	
SUPERSPORT 950/S	21'	9604N	(*)	
STREETFIGHTER V4/S	20' - 21'	9604N	(*)	
HONDA				
CB125R NEO SPORTS CAFE	18' - 21'	9457N	(*)	
CB300R NEO SPORTS CAFE	18' - 21'	9457N	(*)	
CB650R NEO SPORTS CAFÉ	19' - 21'	9457N	(*)	
CB500F	16' - 18'	9327N	(*)	
CB500F	19' - 20'	1945N	(*)	
CB600F HORNET	11' - 15'	9327N	(*)	
CB650F	14' - 16'	9327N	(*)	
CB650F	17' - 20'	9327N	(*)	
CB1000R	08' - 16'	9327N	(*)	
CB1000R NEO SPORTS CAFE	18' - 21'	1945N	(*)	
CB1000R BLACK EDITION	21'	1945N	(*)	

2022 For the new 2022 motorcycle models check www.puig.tv				
MODEL	YEAR	REF.	N	
CBR500R	16' - 21'	9327N	(*)	
CBR650F	17' - 20'	9327N	(*)	
CBR650F	14' - 16'	9327N	(*)	
CBR650R	19' - 21'	9457N	(*)	
CBR1000RR FIREBLADE	04' - 07'	9327N	(*)	
CBR1000RR FIREBLADE	12' - 13'	9327N	(*)	
CBR1000RR FIREBLADE/SP/SP2	17' - 19'	9457N	(*)	
CBR1000RR FIREBLADE/SP	20' - 21'	1945N	(*)	
CMX 500 REBEL	17' - 21'	9327N	(*)	
CMX 500 REBEL S	20' - 21'	9327N	(*)	
CRF1100L AFRICA TWIN	20'	1945N	(*)	
CRF1100L AFRICA TWIN ADVENTURE SPORTS	20'	1945N	(*)	
INTEGRA 700	12' - 13'	9327N	(*)	
INTEGRA 750	14' - 21'	9327N	(*)	
INTEGRA 750S	14' - 16'	9327N	(*)	
NC750S/X	14' - 21'	9327N	(*)	
NC750X	21'	9457N	(*)	
X-ADV	17' - 20'	9457N	(*)	
KAWASAKI				
ER-6F	06' - 16'	9320N	(*)	
ER-6N	05' - 16'	9320N	(*)	
NINJA 125	19' - 21'	9320N	(*)	
NINJA 400	18' - 21'	9320N	(*)	
NINJA 650	17' - 21'	9320N	(*)	
NINJA H2 SX	18' - 21'	9320N	(*)	
NINJA 1000SX	20' - 21'	9320N	(*)	
VERSYS-X 300	17' - 20'	9320N	(*)	
VERSYS 650	10' - 21'	9320N	(*)	
VERSYS 1000	12' - 20'	9320N	(*)	
VULCAN S	15' - 21'	9320N	(*)	
VULCAN S CAFE	17' - 20'	9320N	(*)	
Z125	19' - 21'	9320N	(*)	
Z250SL	15' - 16'	9320N	(*)	
Z300	15' - 17'	9320N	(*)	
Z400	19' - 21'	9320N	(*)	
Z650	17' - 21'	9320N	(*)	
Z750	04' - 12'	9320N	(*)	
Z750R	11' - 12'	9320N	(*)	
Z800/E	13' - 16'	9320N	(*)	
Z900	17' - 21'	9320N	(*)	
Z900RS	18' - 21'	9320N	(*)	
Z900RS CAFÉ	18' - 21'	9320N	(*)	

2022 For the new 2022 motorcycle models check www.puig.tv				
MODEL	YEAR	REF.	N	
Z1000	03' - 19'	9320N	(*)	
Z1000R	17' - 21'	9320N	(*)	
Z1000SX	11' - 19'	9320N	(*)	
ZH2	20' - 21'	9320N	(*)	
Z H2 SE	20' - 21'	9320N	(*)	
ZX-6R	03' - 04'	9320N	(*)	
ZX-6R	18' - 21'	9320N	(*)	
ZX-10R	16' - 21'	9320N	(*)	
ZX-10RR	17' - 21'	9320N	(*)	
ZX-10R SE	18' - 20'	9320N	(*)	
KTM				
125 DUKE	17' - 21'	9324N	(*)	
390 DUKE	17' - 21'	9324N	(*)	
790 DUKE	18' - 21'	9324N	(*)	
890 DUKE R	20' - 21'	9324N	(*)	
690 SUPERMOTO	07' - 11'	9324N	(*)	
1290 SUPERDUKE R	14' - 21'	9324N	(*)	
1290 SUPERDUKE GT	16' - 20'	9324N	(*)	
RC125/RC390	14' - 19'	9324N	(*)	
SUZUKI				
GSR750	11' - 16'	9325N	(*)	
GSX-S125	17' - 21'	9959N	(*)	
GSX-S750	17' - 21'	9452N	(*)	
GSX-S950	22'	9452N	(*)	
GSX-S1000	15' - 17'	9452N	(*)	
GSX-S1000	18' - 21'	9325N	(*)	
GSX-S1000	22'	9452N	(*)	
GSX-S1000F	18' - 21'	9325N	(*)	
GSX-S1000F	15' - 17'	9452N	(*)	
GSX-R125	17' - 21'	9959N	(*)	
GSX-R250	17' - 21'	9524N	(*)	
GSX-R1000	09' - 15'	9325N	(*)	
GSX-R1000	16'	9452N	(*)	
GSX-R1000/R	17' - 20'	9452N	(*)	
KATANA	19' - 21'	9452N	(*)	
SV650	16' - 17'	9452N	(*)	
SV650	18' - 21'	9325N	(*)	
SV650X	18' - 21'	9452N	(*)	
TRIUMPH				
DAYTONA 675	13' - 17'	9322N	(*)	
DAYTONA 675 R	13' - 17'	9322N	(*)	

 N Black

2022 For the new 2022 motorcycle models check www.puig.tv				
MODEL	YEAR	REF.	N	
STREET TRIPLE	13' - 19'	9322N	(*)	
STREET TRIPLE R	13' - 21'	9322N	(*)	
STREET TRIPLE S	17' - 21'	9322N	(*)	
STREET TRIPLE RS	17' - 19'	9322N	(*)	
YAMAHA				
FAZER8	13' - 16'	9319N	(*)	
FZ1	06' - 15'	9319N	(*)	
FZ1 FAZER	06' - 15'	9319N	(*)	
FZ6	04' - 08'	9319N	(*)	
FZ6 S2	07' - 10'	9319N	(*)	
FZ6 FAZER	04' - 08'	9319N	(*)	
FZ6 FAZER S2	07' - 10'	9319N	(*)	
FZ8	10' - 16'	9319N	(*)	
FZ8 FAZER	10' - 12'	9319N	(*)	
MT-03	16' - 21'	9319N	(*)	
MT-07	14' - 21'	9319N	(*)	
MT-07 TRACER	16' - 21'	9319N	(*)	
MT-07 TRACER GT	20' - 21'	9319N	(*)	
MT-09	13' - 16'	9319N	(*)	
MT-09	17' - 21'	9319N	(*)	
MT-09 SP	18' - 21'	9319N	(*)	
MT-09 TRACER	18' - 21'	9319N	(*)	
MT-09 TRACER GT	18' - 20'	9319N	(*)	
MT-125	15' - 19'	9319N	(*)	
MT-125	20' - 21'	9319N	(*)	
TENERE 700	19' - 21'	9319N	(*)	
T-MAX 530/DX/SX	17' - 19'	9319N	(*)	
T-MAX 560 /SX/DX/MAX TECH	20' - 21'	9319N	(*)	
XJ6	09' - 16'	9319N	(*)	
XSR 125	21'	9319N	(*)	
XSR700	16' - 21'	9319N	(*)	
XSR700 XTRIBUTE	19' - 21'	9319N	(*)	
YZF-R125	08' - 13'	9319N	(*)	
YZF-R125	19' - 21'	9319N	(*)	
YZF-R1	09' - 14'	9319N	(*)	
YZF-R1	15' - 21'	9319N	(*)	
YZF-R1M	17' - 21'	9319N	(*)	
YZF-R3	15' - 18'	9319N	(*)	
YZF-R6	06' - 07'	9319N	(*)	
YZF-R6	08' - 20'	9319N	(*)	

NOTE: IT IS POSSIBLE THAT TO MOUNT THE ORIGINAL TURN SIGNALS YOU MIGHT NEED TO EXTEND THE CONNECTIONS.

(*) Check price with your distributor.

IMPORTANT: Indicate code color after part#. Example 0973A.

TAIL LIGHTS

HI-TECH PARTS | TECHNICAL SECTION



OVAL

HOMOLOGATED

	MODEL	REF.	N	W
1	SMILE - BRAKE TAIL LIGHT CLEAR LENS W/LED WITH LICENSE LIGHT 110 x 25 mm. 12v 1w/1w	1359W	(*)	
2	LIB - BRAKE TAIL LIGHT CLEAR LENS W/LED WITH LICENSE LIGHT 100 x 30 mm.	4818N	(*)	
3	BRAKE TAIL LIGHT CLEAR LENS W/LED WITH LICENSE LIGHT 85 x 20 mm.	6073W	(*)	
4	SMILE II - BRAKE TAIL LIGHT CLEAR LENS W/LED WITH LICENSE LIGHT 83 x 20 mm. 12v 0,1w/0,9w	6493W	(*)	
5	SHARK - BRAKE TAIL LIGHT CLEAR LENS W/LED WITH LICENSE LIGHT 83 x 20 mm. 12v 1w/1w	4605W	(*)	
6	SHARK2 - BRAKE TAIL LIGHT CLEAR LENS W/LED WITH LICENSE LIGHT 83 x 20 mm.	8635W	(*)	

N Black

W Transparent

(*) Check price with your distributor.
IMPORTANT: Indicate code color after part#. Example 0973A.



ELONGATED

	MODEL	REF.	R
1	BRAKE TAIL LIGHT W/LEDS 150 x 20 mm.	(*) 0959R	(*)
2	TT - BRAKE TAIL LIGHT W/LEDS 75 x 15 mm. HOMOLOGATED	4602R	(*)

(*) These models cannot be homologated, because do not fulfill the EU standards, their C-Carbon Look use limited for tradeshows exclusively, closed exhibitions and for race tracks.

N Black

R Red

(*) Check price with your distributor.
IMPORTANT: Indicate code color after part#. Example 0973A.



WITH PLASTIC BASE

HOMOLOGATED

	MODEL	REF.	N
	SKIRT + BREAK LIGHT + POSITION LEDES + LICENSE PLATE POSITION LED LIGHT 12v 1w/1w	4312N	(*)



END TUBE FOR EXHAUST

HI-TECH PARTS | TECHNICAL SECTION



REF. 7358A



REF. 95420

MODEL	YEAR	REF.	A N O R
KYMCO			
AK550	17' - 21'	9542	(*)
YAMAHA			
T-MAX 530	12' - 16'	7358	(*)
T-MAX/DX/SX	17' - 19'	CHECK WEB	(*)

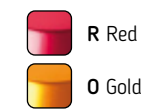

(*) Check price with your distributor.
IMPORTANT: Indicate code color after part#. Example 0973A.

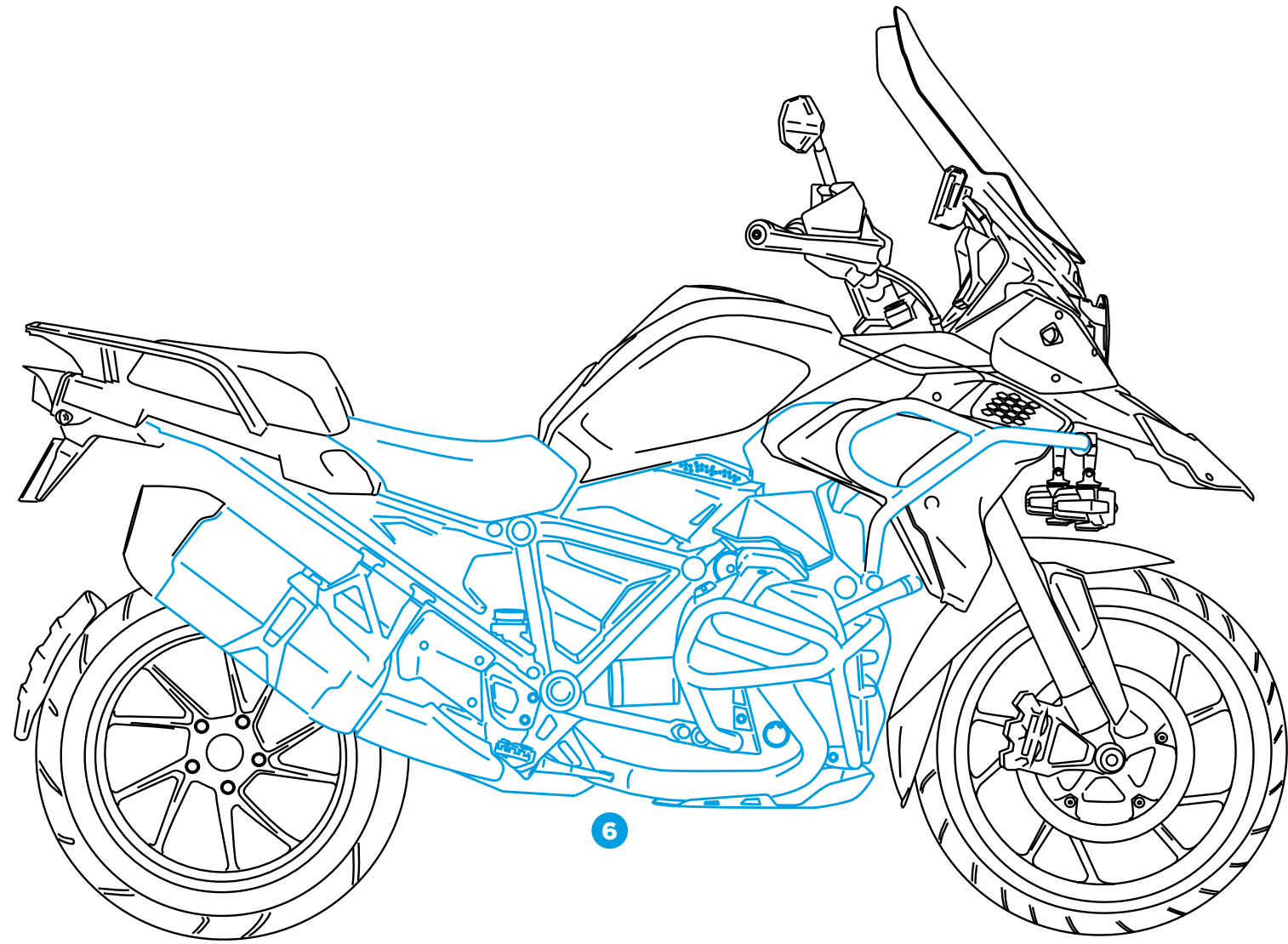

CHASSIS-ENGINE AREA

ALUMINIUM FILTER COVER	545
CHASSIS CAP COVERS	515
CLUTCH COVER	545
CROWN COIL	509
ENGINE GUARDS	537
ENGINE PROTECTIVE COVERS	543
ENGINE SPOILERS	511
EXHAUST PROTECTOR - DEFLECTOR	553
FOOTPEGS ADAPTORS WITH RELOCATION	482
FOOTPEGS ADAPTORS WITHOUT RELOCATION	471
FRAME SLIDERS OPIE	541
FRAME SLIDERS PRO 2.0	517
FRAME SLIDERS PRO	519
FRAME SLIDERS R19	521
FRAME SLIDERS VINTAGE 2.0	525
FRAME SLIDERS VINTAGE	523
FRONT DEFLECTOR	553
HERITAGE FOOTPEGS	469
INTAKE COVER	550
KICKSTAND EXTENSION	505
OFF-ROAD FOOTPEGS	493
PLUG-OIL CAPS	501
R-FIGHTER / R-FIGHTER S FOOTPEGS	461
RACING / SPORT FOOTPEGS	463
REAR BRAKE TANK COVER	549

REAR DEFLECTORS	548
REAR HANDLES COVERS	552
REAR LUGGAGE SUPPORT COVERS	551
SHAFT COVER	508
SHOE PROTECTOR	497
SIDE PANELS	547
SPOOLS	503
SPROCKET COVER	545
TRACK OIL PLUGS	499
TRAIL / ENDURO FOOTPEGS	467
TRAIL 2.0 / ENDURO 2.0 FOOTPEGS	465

R-FIGHTER / R-FIGHTER S FOOTPEGS

HI-TECH PARTS | TECHNICAL SECTION



REF. 91920



DIMENSIONS
74,5 x 26 mm.

DESIGN
Its design offers the best grip.

ADJUSTABLE
On inclination.

PRECISE ADJUSTER
Add marks for proper regulation.

90gr.

REF. 9193P



DIMENSIONS
74,5 x 26 mm.

DESIGN
Rubber base to reduce vibrations.

ADJUSTABLE
On inclination.

PRECISE ADJUSTER
Add marks for proper regulation.

90gr.

R-FIGHTER MODEL	REF.	R O A T N P V
R-FIGHTER FOOTPEGS BY PAIR	9192	(*)
ADAPTERS BY PAIR	SEE PAGE 470	
ADJUSTABLE ADAPTOR KIT	SEE PAGE 482	
RELOCATION BRACKETS SET 20 mm.	3838	(*)
RELOCATION BRACKETS SET 40 mm.	3839	(*)

R-FIGHTER S MODEL	REF.	R O A T N P V
R-FIGHTER S FOOTPEGS BY PAIR	9193	(*)
R-FIGHTER S RUBBERS BY PAIR	9335U	(*)
ADAPTERS BY PAIR	SEE PAGE 470	
ADJUSTABLE ADAPTOR KIT	SEE PAGE 482	
RELOCATION BRACKETS SET 20 mm.	3838	(*)
RELOCATION BRACKETS SET 40 mm.	3839	(*)

R-FIGHTER S MODEL

A Blue P Silver U Rubber

R Red T Orange

N Black V Green

O Gold

TO MOUNT PUIG FOOTPEGS, WE USE PARTS OF OEM FOOTPEGS.
FOOTPEGS FOR RIDERS: all models compatible.
FOOTPEGS FOR PASSANGER: all models compatible except trail and enduro footpegs.

(*) Check price with your distributor.
IMPORTANT: Indicate code color after part#. Example 0973A.



RACING / SPORT FOOTPEGS

HI-TECH PARTS | TECHNICAL SECTION



REF. 6301V

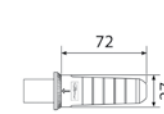

DIMENSIONS
72 x 27 mm.



90gr.



DESIGN
Ergonomic
increasing free
height.



ADJUSTABLE
On inclination.



PRECISE
ADJUSTER
Add marks
for proper
regulation.

RACING MODEL	REF.	R O A T N P V
RACING FOOTPEGS BY PAIR	6301	(*)
ADAPTERS BY PAIR	SEE PAGE 470	
ADJUSTABLE ADAPTOR KIT	SEE PAGE 482	
RELOCATION BRACKETS SET 20 mm.	3838	(*)
RELOCATION BRACKETS SET 40 mm.	3839	(*)

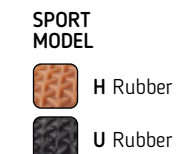
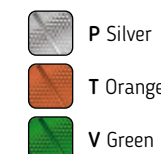
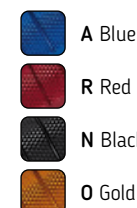

1
REF. 7318T



2
REF. 9189N

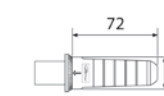

DIMENSIONS
72 x 27 mm.



90gr.



DESIGN
Ergonomic
increasing free
height.



ADJUSTABLE
On inclination.



PRECISE
ADJUSTER
Add marks
for proper
regulation.

SPORT MODEL	REF.	R O A T N P V
SPORT FOOTPEGS BY PAIR (1)	7318	(*)
SPORT RUBBERS BY PAIR (SPARES)	7320U	(*)
VINTAGE FOOTPEGS BY PAIR (2)	9189	(*)
VINTAGE RUBBERS BY PAIR (SPARES)	9334H	(*)
ADAPTERS BY PAIR	SEE PAGE 470	
ADJUSTABLE ADAPTOR KIT	SEE PAGE 482	
RELOCATION BRACKETS SET 20 mm.	3838	(*)
RELOCATION BRACKETS SET 40 mm.	3839	(*)

TO MOUNT PUIG FOOTPEGS, WE USE PARTS OF OEM FOOTPEGS.
FOOTPEGS FOR RIDERS: all models compatible.
FOOTPEGS FOR PASSANGER: all models compatible except trail and enduro footpegs.

(*) Check price with your distributor.
IMPORTANT: Indicate code color after part#. Example 0973A.

TRAIL 2.0 / ENDURO 2.0 FOOTPEGS

HI-TECH PARTS | TECHNICAL SECTION

NEW!



REF. 208530

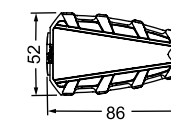
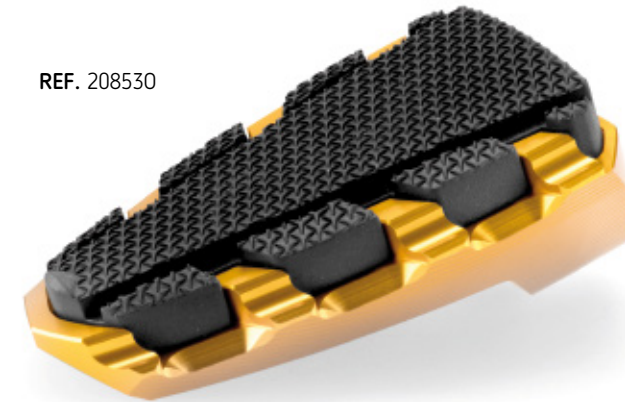

DIMENSIONS
86 x 52 mm.



130gr.



DESIGN
Ergonomic
increasing free
height.

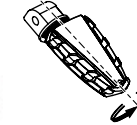

ADJUSTABLE
On inclination.

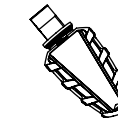

**PRECISE
ADJUSTER**
Add marks
for proper
regulation.

REF. 20851T

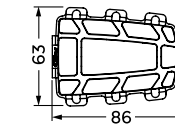

DIMENSIONS
86 x 63 mm.



440gr.

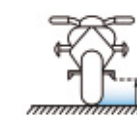

DESIGN
Ergonomic
increasing free
height.

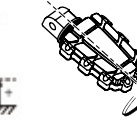

ADJUSTABLE
On inclination.

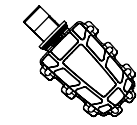

**PRECISE
ADJUSTER**
Add marks
for proper
regulation.

TRAIL 2.0 MODEL	REF.	R O A T N P V
TRAIL FOOTPEGS BY PAIR	20853	(*)
ADAPTERS BY PAIR	SEE PAGE 470	
ADJUSTABLE ADAPTOR KIT	SEE PAGE 482	
TRAIL 2.0 RUBBERS BY PAIR (SPARES)	20854U	(*)
RELOCATION BRACKETS SET 20 mm.	3838	(*)
RELOCATION BRACKETS SET 40 mm.	3839	(*)

ENDURO 2.0 MODEL	REF.	R O A T N P V
ENDURO FOOTPEGS BY PAIR	20851	(*)
ADAPTERS BY PAIR	SEE PAGE 470	
ADJUSTABLE ADAPTOR KIT	SEE PAGE 482	
ENDURO 2.0 RUBBERS BY PAIR (SPARES)	20852U	(*)
RELOCATION BRACKETS SET 20 mm.	3838	(*)
RELOCATION BRACKETS SET 40 mm.	3839	(*)

- A Blue
- R Red
- N Black
- O Gold
- P Silver
- T Orange
- V Green
- U Rubber

TO MOUNT PUIG FOOTPEGS, WE USE PARTS OF OEM FOOTPEGS.
FOOTPEGS FOR RIDERS: all models compatible.
FOOTPEGS FOR PASSANGER: all models compatible except trail and enduro footpegs.

(*) Check price with your distributor.
IMPORTANT: Indicate code color after part#. Example 0973A.



TRAIL / ENDURO FOOTPEGS

HI-TECH PARTS | TECHNICAL SECTION



REF. 7319R

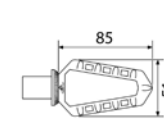

DIMENSIONS
85 x 51 mm.



130gr.



DESIGN
Ergonomic increasing free height.



ADJUSTABLE
On inclination.



PRECISE ADJUSTER
Add marks for proper regulation.

REF. 7587O

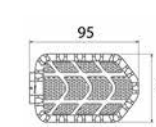

CON O SIN
Las gomas se pueden extraer.



DESIGN
Ergonomic increasing free height.



ADJUSTABLE
On inclination.



PRECISE ADJUSTER
Add marks for proper regulation.

TRAIL MODEL	REF.	R O A T N P V
TRAIL FOOTPEGS BY PAIR	7319	(*)
ADAPTERS BY PAIR	SEE PAGE 470	
ADJUSTABLE ADAPTOR KIT	SEE PAGE 482	
TRAIL RUBBERS BY PAIR (SPARES)	7321U	(*)
RELOCATION BRACKETS SET 20 mm.	3838	(*)
RELOCATION BRACKETS SET 40 mm.	3839	(*)

ENDURO MODEL	REF.	R O A T N P V
ENDURO FOOTPEGS BY PAIR	7587	(*)
ADAPTERS BY PAIR	SEE PAGE 470	
ADJUSTABLE ADAPTOR KIT	SEE PAGE 482	
ENDURO RUBBERS BY PAIR (SPARES)	8133U	(*)
RELOCATION BRACKETS SET 20 mm.	3838	(*)
RELOCATION BRACKETS SET 40 mm.	3839	(*)

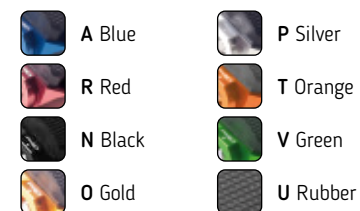

TO MOUNT PUIG FOOTPEGS, WE USE PARTS OF OEM FOOTPEGS.
FOOTPEGS FOR RIDERS: all models compatible.
FOOTPEGS FOR PASSANGER: all models compatible except trail and enduro footpegs.

(*) Check price with your distributor.
IMPORTANT: Indicate code color after part#. Example 0973A.



HERITAGE FOOTPEGS

HI-TECH PARTS | TECHNICAL SECTION

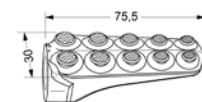

DIMENSIONS
75,5 x 30 mm.

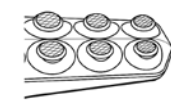

DESIGN
Ergonomic
increasing free
height.



ADJUSTABLE
On inclination.



PRECISE ADJUSTER
Add marks for
proper regulation.



N Black



REF. 9980N

HERITAGE MODEL	REF.	N
HERITAGE FOOTPEGS BY PAIR	9980	(*)
ADAPTERS BY PAIR	SEE PAGE 470	
ADJUSTABLE ADAPTOR KIT	SEE PAGE 482	
RELOCATION BRACKETS SET 20 mm.	3838	(*)
RELOCATION BRACKETS SET 40 mm.	3839	(*)

TO MOUNT PUIG FOOTPEGS, WE USE PARTS OF OEM FOOTPEGS.
FOOTPEGS FOR RIDERS: all models compatible.
FOOTPEGS FOR PASSANGER: all models compatible except trail and enduro footpegs.

(*) Check price with your distributor.

IMPORTANT: Indicate code color after part#. Example 0973A.

FOOTPEGS ADAPTORS

HI-TECH PARTS | TYPE OF FOOTPEGS ADAPTORS:

At Puig we have developed a new range of footpeg adaptors that allows the rider to adjust the position of the foot to their liking and at the same time improve their ergonomics on the bike. The image below shows you the difference between the non-adjustable footpeg adaptors and the new adjustable footpeg adaptors (with 20 mm. offset). Adjustable footpeg adaptor and standard is not the same part number.

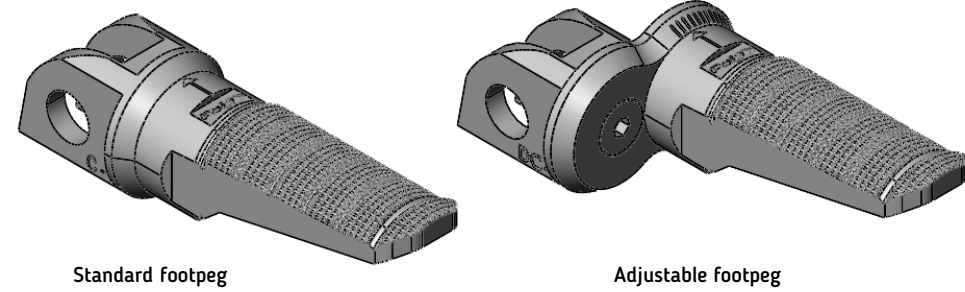

Standard footpeg

Adjustable footpeg

Two types of shifters are offered depending on the degree of offset desired. The 20 mm. displacer has been designed for rider and passenger. On the other hand, the 40 mm. displacer has been developed only for the passenger and especially for sports motorcycles.

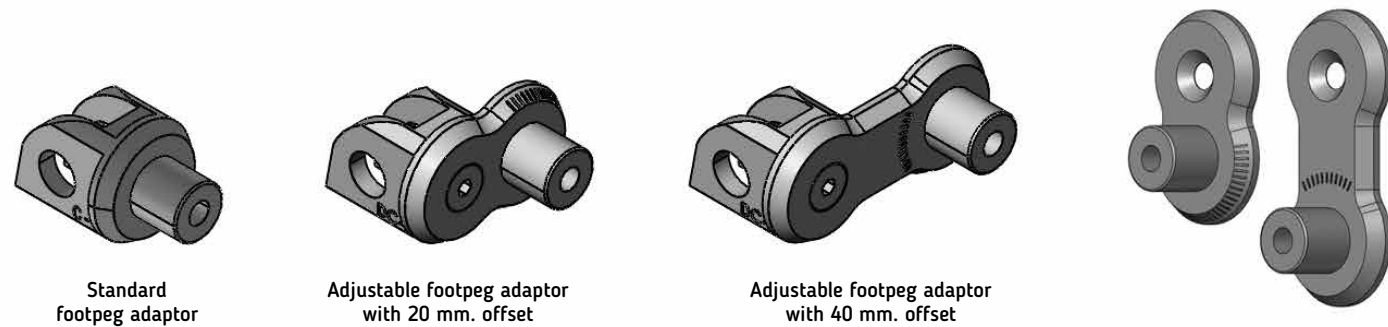

Standard footpeg adaptor

Adjustable footpeg adaptor with 20 mm. offset

Adjustable footpeg adaptor with 40 mm. offset

The displacer allows for both a more relaxed and sporty ride. For example, riders with small feet can move the footrest further forward for greater control. And those who prefer a sportier ride can choose to set back the footpegs. All this is possible due to the adjustment options that the displacer allows, the footrest pivots 360° in 15° intervals.

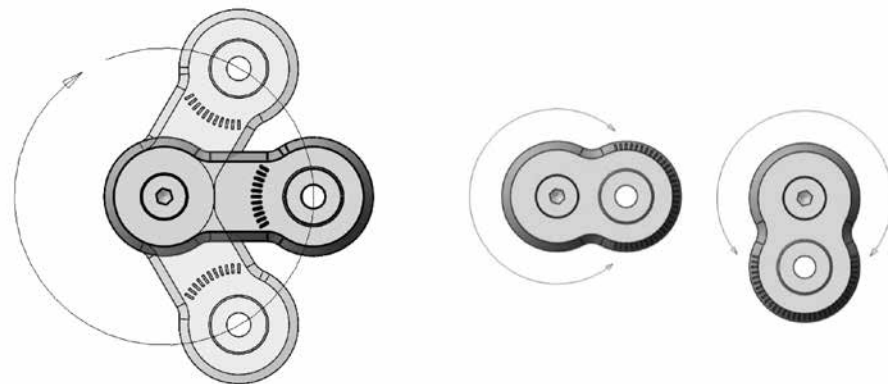

FOOTPEGS ADAPTORS WITHOUT RELOCATION

HI-TECH PARTS



2022		For the new 2022 motorcycle models check www.puig.tv			
MODEL	YEAR	ADAPTER BY PAIR RIDER	N	ADAPTER BY PAIR PASSENGER	N
APRILIA					
CAPONORD 1200	13' - 16	7232N	(*)	7233N	(*)
DORSODURO 900	17' - 21'	9641N	(*)	9870N	(*)
RS 660	21'	6864N	(*)	6339N	(*)
RSV4	09' - 12'	6864N	(*)	6865N	(*)
RSV4 FACTORY	13' - 14'	6864N	(*)	6865N	(*)
SHIVER 750	07' - 16'	6338N	(*)	6339N	(*)
SHIVER 900	17' - 21'	6338N	(*)	9870N	(*)
SRV850	12' - 16'			6633N	(*)
TUONO 660	21'	6338N	(*)	6633N	(*)
TUONO V4R	11' - 14'	6864N	(*)	6865N	(*)
BENELLI					
LEONCINO 250	20' - 21'	9696N	(*)	9697N	(*)
LEONCINO 500	16' - 21'	9696N	(*)	9697N	(*)
BMW					
C600 SPORT	12' - 14'			6341N	(*)
C600 SPORT	15'			8771N	(*)
C650 SPORT	16' - 20'			8771N	(*)
F650 GS	08' - 12'	7238N	(*)	7239N	(*)
F700 GS	12' - 17'	7238N	(*)	7239N	(*)
F750 GS	18' - 21'	7246N	(*)	9784N	(*)
F800 GT	13' - 20'			6647N	(*)
F800 GS	08' - 17'	7238N	(*)	7239N	(*)
F800 GS ADVENTURE	13' - 18'	7238N	(*)	7239N	(*)
F800 R	09' - 20'	6340N	(*)	6341N	(*)
F850 GS	18' - 21'	7246N	(*)	9784N	(*)
F850 GS ADVENTURE	19' - 21'	9471N	(*)	9784N	(*)
F900 R	20' - 21'	7200N	(*)	6647N	(*)
F900 XR	20' - 21'	7200N	(*)	6647N	(*)
G310 GS	17' - 21'	9950N	(*)	8770N	(*)
G310 R	16' - 21'	8876N	(*)	8770N	(*)
G650 GS	11' - 16'	7240N	(*)	7241N	(*)
K1200R	05' - 08'	6340N	(*)	6341N	(*)

NOTE: TO MOUNT PUIG FOOTPEGS, WE USE PARTS OF OEM FOOTPEGS.

(*) Check price with your distributor.

IMPORTANT: Indicate code color after part#. Example 0973A.

N Black

FOOTPEGS ADAPTORS WITHOUT RELOCATION

HI-TECH PARTS



2022		For the new 2022 motorcycle models check www.puig.tv				
MODEL	YEAR	ADAPTER BY PAIR RIDER	N	ADAPTER BY PAIR PASSENGER	N	
K1300 R	09' - 16'	6340N	(*)	6341N	(*)	
R1200 GS	04' - 12'			7243N	(*)	
R1200 GS	13' - 16'	7246N	(*)	7249N	(*)	
R1200 GS	17' - 18'	7246N	(*)	7249N	(*)	
R1200 GS RALLYE	17' - 18'	9471N	(*)	7249N	(*)	
R1200 GS EXCLUSIVE	17' - 18'	7246N	(*)	7249N	(*)	
R1200 GS ADVENTURE	06' - 13'	7248N	(*)	7245N	(*)	
R1200GS ADVENTURE	14' - 18'	7248N	(*)	7249N	(*)	
R1200 R	10' - 14'			6647N	(*)	
R1200 R	15' - 18'	7200N	(*)	6647N	(*)	
R1200 RS	15' - 18'	7200N	(*)	6647N	(*)	
R1250 GS	18' - 21'	7246N	(*)	7249N	(*)	
R1250 GS ADVENTURE	18' - 20'	9471N	(*)	7249N	(*)	
R1250 GS HP	18' - 21'	9471N	(*)	7249N	(*)	
R1250 GS RALLYE	18' - 21'	9471N	(*)	7249N	(*)	
R1250 R	19' - 21'	7200N	(*)	6647N	(*)	
R1250 RS	19' - 21'	7200N	(*)	6647N	(*)	
R NINE T	14' - 20'	7200N	(*)	6647N	(*)	
R NINE T	21'	7200N	(*)	6647N	(*)	
R NINE T SCRAMBLER	16' - 21'	8877N	(*)	6647N	(*)	
R NINE T PURE	17' - 21'	7200N	(*)	6647N	(*)	
R NINE T RACER	17' - 20'	6866N	(*)			
R NINE T RACER	21'	7200N	(*)	6647N	(*)	
R NINE T URBAN G/S	17' - 21'	8877N	(*)	6647N	(*)	
S1000 R	14' - 21'	6866N	(*)	7203N	(*)	
S1000RR	09' - 21'	6866N	(*)	7203N	(*)	
S1000 XR	15' - 19'	7246N	(*)	7249N	(*)	
S1000 XR	20' - 21'	7200N	(*)	6647N	(*)	
DUCATI						
848	08' - 13'	6997N	(*)	6997N	(*)	
899 PANIGALE	14' - 15'	6997N	(*)	6997N	(*)	
959 PANIGALE	16' - 19'	6997N	(*)	6997N	(*)	
1199 PANIGALE	12' - 14'	6997N	(*)	6997N	(*)	
1199 SUPERLEGGERA	14'	6997N	(*)	6997N	(*)	
1299 PANIGALE/S	15' - 17'	6997N	(*)	6997N	(*)	
PANIGALE V2	20' - 21'	6997N	(*)	6997N	(*)	
PANIGALE V2 BAYLISS	21'	6997N	(*)	6997N	(*)	

2022

For the new 2022 motorcycle models check www.puig.tv

MODEL	YEAR	ADAPTER BY PAIR RIDER	N	ADAPTER BY PAIR PASSENGER	N
PANIGALE 1100 V4	18' - 21'	6997N	(*)		
PANIGALE 1100 V4S	18' - 21'	6997N	(*)		
HYPERMOTARD 821/SP	13' - 15'	6755N	(*)	6755N	(*)
HYPERMOTARD 939/SP	16' - 18'	6755N	(*)	6755N	(*)
HYPERMOTARD 950/SP	19' - 21'	7874N	(*)	7874N	(*)
HYPERMOTARD 950 RVE	21'	7874N	(*)	7874N	(*)
HYPERSTRADA	13' - 15'	6755N	(*)	6755N	(*)
HYPERSTRADA 939/SP	16' - 17'	8880N	(*)	8776N	(*)
MONSTER 696	08' - 14'	6342N	(*)	6342N	(*)
MONSTER 796	10' - 14'	6342N	(*)	6342N	(*)
MONSTER 797	17' - 20'	7874N	(*)	7874N	(*)
MONSTER 821	14' - 20'	7206N	(*)	7206N	(*)
MONSTER 937	21'	7206N	(*)	7206N	(*)
MONSTER 937 PLUS	21'	7206N	(*)	7206N	(*)
MONSTER 1100	09' - 10'	6342N	(*)	6342N	(*)
MONSTER 1100 S	09' - 10'	6342N	(*)	6342N	(*)
MONSTER 1100 EVO	11' - 13'	6342N	(*)	6342N	(*)
MONSTER 1200/S	14' - 16'	7206N	(*)	7206N	(*)
MONSTER 1200/S	17' - 21'	7206N	(*)	7206N	(*)
MONSTER 1200 R	16' - 20'	6997N	(*)	8778N	(*)
MULTISTRADA 950	17' - 21'	9480N	(*)	9480N	(*)
MULTISTRADA 1200/ S	10' - 14'	6755N	(*)	6755N	(*)
MULTISTRADA 1200/S	15' - 17'	6755N	(*)	6755N	(*)
MULTISTRADA 1200 ENDURO/PRO	16' - 19'	8881N	(*)	8779N	(*)
MULTISTRADA 1200 PIKES PEAK	16' - 17'	6755N	(*)	6755N	(*)
MULTISTRADA 1260/S/S DJAIR	18' - 20'	9480N	(*)	9480N	(*)
MULTISTRADA 1260 PIKES PEAK	18' - 20'	9480N	(*)	9480N	(*)
MULTISTRADA 1260 ENDURO	18' - 21'	20269N	(*)	9480N	(*)
MULTISTRADA V4	21'	20269N	(*)	20274N	(*)
MULTISTRADA V4S/S SPORT	21'	20269N	(*)	20274N	(*)
SCRAMBLER 1100	18' - 21'	7206N	(*)	7874N	(*)
SCRAMBLER 1100 SPORT	18' - 21'	7206N	(*)	7874N	(*)
SCRAMBLER 1100 SPECIAL	18' - 21'	7206N	(*)	7874N	(*)
SCRAMBLER ICON/CLASSIC/FULL THROTTLE	15' - 21'	7874N	(*)	7874N	(*)
SCRAMBLER SIXTY2	16' - 21'	7874N	(*)	7874N	(*)
SCRAMBLER URBAN ENDURO	15' - 16'	7874N	(*)	7874N	(*)
SCRAMBLER FLAT TRACK PRO	16'	7874N	(*)	7874N	(*)
SCRAMBLER DESERT SLED	17' - 20'	7206N	(*)	9480N	(*)
SCRAMBLER CAFE RACER	17' - 21'	7874N	(*)	7874N	(*)
STREETFIGHTER 848	12' - 15'	6997N	(*)	6997N	(*)

NOTE: TO MOUNT PUIG FOOTPEGS, WE USE PARTS OF OEM FOOTPEGS.

(*) Check price with your distributor.

IMPORTANT: Indicate code color after part#. Example 0973A.



FOOTPEGS ADAPTORS WITHOUT RELOCATION

HI-TECH PARTS



2022		For the new 2022 motorcycle models check www.puig.tv				
MODEL	YEAR	ADAPTER BY PAIR RIDER	N	ADAPTER BY PAIR PASSENGER	N	
STREETFIGHTER V4/S	20' - 21'	6997N	(*)	6997N	(*)	
SUPERSPORT 939/S	17' - 20'	7874N	(*)	7874N	(*)	
SUPERSPORT 950/S	21'	7206N	(*)	7874N	(*)	
HARLEY DAVIDSON						
SPORTSTER 883 IRON	09' - 20'	9997N	(*)	9997N	(*)	
HONDA						
CB125R NEO SPORTS CAFE	18' - 21'	6347N	(*)	6343N	(*)	
CB300R NEO SPORTS CAFE	18' - 21'	6347N	(*)	6343N	(*)	
CB500F	13' - 15'	6703N	(*)			
CB500F	16' - 21'	6703N	(*)	6343N	(*)	
CB500X	13' - 21'	6703N	(*)			
CB600F HORNET	02' - 06'	6347N	(*)			
CB600F HORNET	07' - 15'	6347N	(*)	6448N	(*)	
CB650F	14' - 20'	6347N	(*)	6343N	(*)	
CB650R NEO SPORTS CAFE	19' - 21'	6347N	(*)	6343N	(*)	
CB1000R NEO SPORTS CAFE	18' - 21'	6347N	(*)	6343N	(*)	
CB1000R BLACK EDITION	21'	6347N	(*)	6343N	(*)	
CB1000R	08' - 16'	6347N	(*)	6448N	(*)	
CB1100	13' - 14'	6456N	(*)	6357N	(*)	
CB1100RS	17' - 21'	6346N	(*)	6343N	(*)	
CB1100EX	17' - 21'	6346N	(*)	6343N	(*)	
CMX 500 REBEL	17' - 21'	9619N	(*)	6343N	(*)	
CMX 500 REBEL S	20' - 21'	9619N	(*)	6343N	(*)	
CMX 1100 REBEL	21'	6347N	(*)	6343N	(*)	
CBF600	04' - 14'	6347N	(*)			
CBF600S	08' - 14'	6347N	(*)			
CBF1000	06' - 11'	6347N	(*)			
CBR250R	11' - 14'	6347N	(*)			
CBR500R	13' - 15'	6703N	(*)			
CBR500R	16' - 21'	6703N	(*)	6343N	(*)	
CBR600F	01' - 13'	6347N	(*)	6448N	(*)	
CBR600RR	03' - 16'	6347N	(*)	6448N	(*)	
CBR650F	14' - 19'	6347N	(*)	6343N	(*)	
CBR650R	19' - 21'	6347N	(*)	6343N	(*)	
CBR900RR FIRE BLADE	00' - 01'	6347N	(*)	6448N	(*)	
CBR900RR FIRE BLADE	02' - 03'	6347N	(*)	6448N	(*)	
CBR1000RR FIREBLADE	04' - 13'	6347N	(*)	6448N	(*)	

2022		For the new 2022 motorcycle models check www.puig.tv				
MODEL	YEAR	ADAPTER BY PAIR RIDER	N	ADAPTER BY PAIR PASSENGER	N	
CBR1000RR FIREBLADE/SP	14' - 16'	6347N	(*)	6448N	(*)	
CBR1000RR FIREBLADE/SP/SP2	17' - 19'	6703N	(*)			
CBR1000RR FIREBLADE/SP	20' - 21'	6347N	(*)	6343N	(*)	
CRF1100L AFRICA TWIN	20'	3869N	(*)	8783N	(*)	
CRF1100L AFRICA TWIN ADVENTURE SPORTS	20'	3869N	(*)	8783N	(*)	
CROSSRUNNER	11' - 14'	6344N	(*)	6345N	(*)	
CROSSRUNNER	15' - 21'	6703N	(*)	6343N	(*)	
CROSSTOURER	12' - 21'	6703N	(*)	7261N	(*)	
FORZA 750	21'			20759N	(*)	
INTEGRA 700	12' - 13'			6343N	(*)	
INTEGRA 750	14' - 21'			6343N	(*)	
INTEGRA 750S	14' - 16'			6343N	(*)	
MONKEY 125	18' - 21'	6703N	(*)			
MSX125	14' - 20'	6347N	(*)	6345N	(*)	
NC700S/X	12' - 13'	6346N	(*)	6343N	(*)	
NC750S/X	14' - 15'	6346N	(*)	6343N	(*)	
NC750S/X	16' - 21'	6703N	(*)	6343N	(*)	
VFR800F	14' - 20'	6703N	(*)	6343N	(*)	
VFR1200F	10' - 16'	6346N	(*)	6349N	(*)	
VTR1000 SP-1	00' - 02'	6347N	(*)	6448N	(*)	
VTR1000 SP-2	02' - 05'	6347N	(*)	6448N	(*)	
X-ADV	17' - 20'	9484N	(*)			
X-ADV	21'	20582N	(*)			
INDIAN						
FTR 1200	19' - 21'	20465N	(*)	20466N	(*)	
FTR 1200 S	19' - 21'	20465N	(*)	20466N	(*)	
SCOUT	15' - 21'	9745N	(*)			
SCOUT BOBBER	15' - 21'	9745N	(*)			
KAWASAKI						
ER-6F	06' - 16'	6449N	(*)	6351N	(*)	
ER-6N	05' - 16'	6449N	(*)	6351N	(*)	
NINJA 125	19' - 21'	6449N	(*)	6451N	(*)	
NINJA 250R	08' - 12'	6449N	(*)	6451N	(*)	
NINJA 250SL	15' - 16'	6449N	(*)	6451N	(*)	
NINJA 300	13' - 17'	6449N	(*)	6451N	(*)	
NINJA 400	18' - 21'	8887N	(*)	6351N	(*)	
NINJA 650	17' - 21'	6449N	(*)	6351N	(*)	
NINJA 1000 SX	20' - 21'	6450N	(*)	6351N	(*)	
NINJA H2 SX	18' - 21'	6450N	(*)	6351N	(*)	
VERSYS-X 300	17' - 20'	6449N	(*)	6451N	(*)	

NOTE: TO MOUNT PUIG FOOTPEGS, WE USE PARTS OF OEM FOOTPEGS.

(*) Check price with your distributor.

IMPORTANT: Indicate code color after part#. Example 0973A.



N Black

FOOTPEGS ADAPTORS WITHOUT RELOCATION

HI-TECH PARTS



2022		For the new 2022 motorcycle models check www.puig.tv				
MODEL	YEAR	ADAPTER BY PAIR RIDER	N	ADAPTER BY PAIR PASSENGER	N	
VERSYS 650	10' - 21'	6449N	(*)	6351N	(*)	
VERSYS 1000	12' - 20'	6449N	(*)	6351N	(*)	
VULCAN S	15' - 21'	9617N	(*)	9618N	(*)	
VULCAN S CAFE	17' - 20'	9617N	(*)	9618N	(*)	
Z125	17' - 21'	6449N	(*)	6451N	(*)	
Z250SL	15' - 16'	6449N	(*)	6451N	(*)	
Z300	15' - 17'	6449N	(*)	6451N	(*)	
Z400	19' - 21'	8887N	(*)	6351N	(*)	
Z650	17' - 21'	6449N	(*)	6351N	(*)	
Z750	04' - 12'	6450N	(*)	6351N	(*)	
Z750R	11' - 12'	6677N	(*)	6351N	(*)	
Z800	13' - 16'	6677N	(*)	6351N	(*)	
Z800E	13' - 16'	6677N	(*)	6351N	(*)	
Z900	17' - 21'	6449N	(*)	6351N	(*)	
Z900RS	18' - 21'	6449N	(*)	6351N	(*)	
Z900RS CAFÉ	18' - 21'	6449N	(*)	6351N	(*)	
Z1000	03' - 09'	6450N	(*)	6351N	(*)	
Z1000	10' - 13'	6677N	(*)	6351N	(*)	
Z1000	14' - 21'	6677N	(*)	6351N	(*)	
Z1000R	17' - 21'	6677N	(*)	6351N	(*)	
Z1000SX	17' - 19'	6450N	(*)	6351N	(*)	
ZH2	20' - 21'	6677N	(*)	6351N	(*)	
Z H2 SE	20' - 21'	6677N	(*)	6351N	(*)	
ZX-6R	03' - 16'	6677N	(*)	6351N	(*)	
ZX-6R	18' - 21'	6677N	(*)	6351N	(*)	
ZX-6R 636	13' - 16'	6677N	(*)	6351N	(*)	
ZX-10R	04' - 10'	6677N	(*)	6351N	(*)	
ZX-10R	11' - 15'	6351N	(*)	6351N	(*)	
ZX-10R	16' - 20'	8887N	(*)	6351N	(*)	
ZX-10R	21'	8887N	(*)	6351N	(*)	
ZX-10RR	17' - 20'	8887N	(*)	6351N	(*)	
ZX-10RR	21'	8887N	(*)	6351N	(*)	
ZX-10R SE	18' - 20'	8887N	(*)	6351N	(*)	
ZZR1400	12' - 21'	6450N	(*)	6351N	(*)	
KTM						
125 DUKE	11' - 16'	6338N	(*)	9520N	(*)	
125 DUKE	17' - 21'	6338N	(*)	9520N	(*)	

2022		For the new 2022 motorcycle models check www.puig.tv				
MODEL	YEAR	ADAPTER BY PAIR RIDER	N	ADAPTER BY PAIR PASSENGER	N	
200 DUKE	12' - 15'	6338N	(*)	6770N	(*)	
390 ADVENTURE	20' - 21'	7210N	(*)	7211N	(*)	
390 DUKE	13' - 16'	6338N	(*)	6770N	(*)	
390 DUKE	17' - 21'	6338N	(*)	9520N	(*)	
690 DUKE	16' - 20'	7210N	(*)	7211N	(*)	
690 DUKE R	16' - 17'	7210N	(*)	7211N	(*)	
790 DUKE	18' - 21'	7210N	(*)	7211N	(*)	
790 ADVENTURE/R	19' - 21'	7268N	(*)	3695N	(*)	
890 ADVENTURE	21'	7268N	(*)	3695N	(*)	
990 SUPERMOTO	08' - 13'	7268N	(*)	7269N	(*)	
1050 ADVENTURE	15' - 16'	7268N	(*)	7269N	(*)	
1090 ADVENTURE /R	17' - 20'	7268N	(*)	7269N	(*)	
1190 ADVENTURE/R	13' - 16'	7268N	(*)	7269N	(*)	
1290 SUPER ADVENTURE	15' - 16'	7268N	(*)	7269N	(*)	
1290 SUPER ADVENTURE R	17' - 20'	7268N	(*)	7269N	(*)	
1290 SUPER ADVENTURE S	17' - 20'	7268N	(*)	7269N	(*)	
1290 SUPER ADVENTURE R/S	21'	7268N	(*)	3695N	(*)	
1290 SUPER ADVENTURE T	17' - 20'	7268N	(*)	7269N	(*)	
1290 SUPERDUKE GT	19' - 21'	7208N	(*)			
1290 SUPERDUKE R	20' - 21'	20452N	(*)	20454N	(*)	
RC125/RC390	14' - 21'	7210N	(*)	7211N	(*)	
KYMCO						
AK 550	17' - 21'			9541N	(*)	
MV AGUSTA						
BRUTALE 675	12' - 18'	6867N	(*)	6868N	(*)	
BRUTALE 800/RR	13' - 18'	6867N	(*)	6868N	(*)	
BRUTALE 1000RR	20' - 21'	6867N	(*)	6868N	(*)	
F3 675	12' - 21'	6867N	(*)	6868N	(*)	
F4 1000	10' - 20'	6867N	(*)	6868N	(*)	
SUPERVELOCE	21'	6867N	(*)	6868N	(*)	
TURISMO VELOCE 800/LUSSO	14' - 21'	9235N	(*)	9235N	(*)	
SUZUKI						
B-KING	08' - 11'	6453N	(*)	6353N	(*)	
DL250 V-STROM	17' - 21'	6453N	(*)	9963N	(*)	
DL650 V-STROM	04' - 21'	6791N	(*)	7271N	(*)	
DL650XT V-STROM	15' - 21'	6791N	(*)	7271N	(*)	
DL1000 V-STROM	14' - 19'	6791N	(*)	7275N	(*)	
DL1000XT V-STROM	17' - 19'	6791N	(*)	7275N	(*)	
DL1050 V-STROM	20' - 21'	20405N	(*)	7275N	(*)	
DL1050XT V-STROM	20' - 21'	20405N	(*)	7275N	(*)	



NOTE: TO MOUNT PUIG FOOTPEGS, WE USE PARTS OF OEM FOOTPEGS.

(*) Check price with your distributor.

IMPORTANT: Indicate code color after part#. Example 0973A.

FOOTPEGS ADAPTORS WITHOUT RELOCATION

HI-TECH PARTS



2022						
For the new 2022 motorcycle models check www.puig.tv						
MODEL	YEAR	ADAPTER BY PAIR RIDER	N	ADAPTER BY PAIR PASSENGER	N	
GSR600	06' - 11'	6453N	(*)	6353N	(*)	
GSR750	11' - 16'	6453N	(*)	6353N	(*)	
GSX-R125	17' - 21'	6453N	(*)	9963N	(*)	
GSX-R250	17' - 21'	6791N	(*)	9657N	(*)	
GSX-R600	01' - 05'	6449N	(*)			
GSX-R600	06' - 16'	6453N	(*)	6353N	(*)	
GSX-R750	01' - 05'	6449N	(*)			
GSX-R750	06' - 16'	6453N	(*)	6353N	(*)	
GSX-R1000	01' - 04'	6453N	(*)			
GSX-R1000	05' - 16'	6453N	(*)	6353N	(*)	
GSX-R1000/R	17' - 20'	6453N	(*)	9495N	(*)	
GSX-S125	17' - 21'	6453N	(*)	9963N	(*)	
GSX-S750	17' - 21'	6453N	(*)	9495N	(*)	
GSX-S950	22'	6453N	(*)	7923N	(*)	
GSX-S1000	15' - 22'	6453N	(*)	7923N	(*)	
GSX-S1000F	15' - 21'	6453N	(*)	7923N	(*)	
INAZUMA	13' - 17'	6791N	(*)	6353N	(*)	
KATANA	19' - 21'	6453N	(*)	9495N	(*)	
SFV650 GLADIUS	09' - 15'	6453N	(*)	6353N	(*)	
SV650S	03' - 08'	6449N	(*)			
SV650	16' - 21'	6453N	(*)	6353N	(*)	
SV650X	18' - 21'	6453N	(*)	6353N	(*)	
SV1000S	03' - 05'	6449N	(*)			
SYM						
MAXSYM TL	20' - 21'			20636N	(*)	
TRIUMPH						
BONNEVILLE T100/T120	16' - 19'	6797N	(*)	6798N	(*)	
BONNEVILLE BOBBER	17' - 21'	6797N	(*)			
BONNEVILLE BOBBER BLACK	20' - 21'	6797N	(*)			
DAYTONA 675	09' - 17'	6797N	(*)	6798N	(*)	
DAYTONA 675 R	11' - 17'	6797N	(*)	6798N	(*)	
SCRAMBLER 1200XC	19' - 21'	7276N	(*)	6798N	(*)	
SCRAMBLER 1200XE	19' - 21'	7276N	(*)	6798N	(*)	
SPEED TRIPLE	11' - 15'	6797N	(*)	6798N	(*)	
SPEED TRIPLE/R	16' - 20'	6797N	(*)	6798N	(*)	
SPEED TWIN	19' - 21'	6797N	(*)	6798N	(*)	
STREET CUP	17' - 20'	6797N	(*)	6798N	(*)	

2022					
For the new 2022 motorcycle models check www.puig.tv					
MODEL	YEAR	ADAPTER BY PAIR RIDER	N	ADAPTER BY PAIR PASSENGER	N
STREET SCRAMBLER	17' - 21'	7276N	(*)	6798N	(*)
STREET TRIPLE	08' - 19'	6797N	(*)	6798N	(*)
STREET TRIPLE R	09' - 21'	6797N	(*)	6798N	(*)
STREET TRIPLE S	17' - 21'	6797N	(*)	6798N	(*)
STREET TRIPLE RS	17' - 19'	6797N	(*)	6798N	(*)
STREET TWIN	16' - 21'	6797N	(*)	6798N	(*)
THRUXTON 1200/R	16' - 20'	6797N	(*)	6798N	(*)
THRUXTON 1200RS	20' - 21'	6797N	(*)		
TRIDENT 660	21'	6797N	(*)	6798N	(*)
TIGER 800	11' - 14'	7276N	(*)	7277N	(*)
TIGER 800 XC	11' - 14'	7276N	(*)	7277N	(*)
TIGER 800 XC/XCX/XCA	15' - 20'	7276N	(*)	7277N	(*)
TIGER 800 XR/XRX/XRT	15' - 20'	7276N	(*)	7277N	(*)
TIGER 900	20' - 21	20386N	(*)	6798N	(*)
TIGER 900 GT	20' - 21	20386N	(*)	6798N	(*)
TIGER 900 GT LOW	20' - 21	20386N	(*)	6798N	(*)
TIGER 900 GT PRO	20' - 21	20386N	(*)	6798N	(*)
TIGER 900 RALLY	20' - 21	20386N	(*)	6798N	(*)
TIGER 900 RALLY PRO	20' - 21	20386N	(*)	6798N	(*)
TIGER SPORT	13' - 20'	6797N	(*)	7576N	(*)
TIGER EXPLORER	12' - 15'	8796N	(*)	8798N	(*)
TIGER EXPLORER XC	13' - 15'	8796N	(*)	8798N	(*)
TIGER EXPLORER XC/XR/XRX/XRT/XCX/XCA	16' - 20'	8796N	(*)	8798N	(*)
TIGER 1200 ALPINE	21'	8796N	(*)	8798N	(*)
TIGER 1200 DESERT	21'	8796N	(*)	8798N	(*)
YAMAHA					
FAZER8	13' - 16'	6455N	(*)	8183N	(*)
FJR1300A/AS	13' - 19'	6456N	(*)	6359N	(*)
FZ1	06' - 15'	6455N	(*)	6357N	(*)
FZ1 FAZER	06' - 15'	6455N	(*)	6357N	(*)
FZ6	04' - 08'	6456N	(*)	6359N	(*)
FZ6 FAZER	07' - 08'	6456N	(*)	6359N	(*)
FZ6 FAZER S2	07' - 10'	6456N	(*)	6359N	(*)
FZ8	10' - 12'	6455N	(*)	8183N	(*)
FZ8	13' - 16'	6455N	(*)	8183N	(*)
FZ8 FAZER	10' - 12'	6455N	(*)	8183N	(*)
FZS1000 FAZER	01' - 05'	6455N	(*)	6359N	(*)
MT-125	14' - 21'	6454N	(*)	6357N	(*)
MT-03	16' - 21'	6454N	(*)	6357N	(*)
MT-07	14' - 21'	6456N	(*)	6357N	(*)



NOTE: TO MOUNT PUIG FOOTPEGS, WE USE PARTS OF OEM FOOTPEGS.

(*) Check price with your distributor.

IMPORTANT: Indicate code color after part#. Example 0973A.

FOOTPEGS ADAPTORS WITHOUT RELOCATION

HI-TECH PARTS



2022		For the new 2022 motorcycle models check www.puig.tv				
MODEL	YEAR	ADAPTER BY PAIR RIDER	N	ADAPTER BY PAIR PASSENGER	N	
MT-07 TRACER	16' - 19'	6456N	(*)	6359N	(*)	
MT-07 TRACER	20' - 21'	6456N	(*)	20445N	(*)	
MT-07 TRACER GT	19'	6456N	(*)	6359N	(*)	
MT-07 TRACER GT	20' - 21'	6456N	(*)	20445N	(*)	
MT-09	13' - 16'	6456N	(*)	6357N	(*)	
MT-09	17' - 20'	6456N	(*)	6357N	(*)	
MT-09	21'	20673N	(*)	20676N	(*)	
MT-09 SP	18' - 20'	6456N	(*)	6357N	(*)	
MT-09 SP	21'	20673N	(*)	20676N	(*)	
MT-09 TRACER	15' - 20'	6456N	(*)	6357N	(*)	
MT-09 TRACER	21'	20673N	(*)	20838N	(*)	
MT-09 TRACER GT	18' - 20'	6456N	(*)	6357N	(*)	
MT-09 TRACER GT	21'	20673N	(*)	20838N	(*)	
MT-10	16' - 21'	8896N	(*)	6357N	(*)	
MT-10 SP	17' - 21'	8896N	(*)	6357N	(*)	
NIKEN	18' - 21'	6456N	(*)	6357N	(*)	
SCR950	17' - 21'	6456N	(*)			
TENERE 700	19' - 21'	3815N	(*)	6357N	(*)	
T-MAX 500	08' - 11'			6355N	(*)	
T-MAX 530	12' - 14'			6355N	(*)	
T-MAX 530	15' - 16'			6355N	(*)	
T-MAX 530/DX/SX	17' - 19'			6357N	(*)	
T-MAX 560 /SX/DX/MAX TECH	20' - 21'			6357N	(*)	
XJ6	09' - 16'	6456N	(*)	6355N	(*)	
XJ6 DIVERSION	09' - 16'	6456N	(*)	6355N	(*)	
XJ6 DIVERSION F	10' - 16'	6456N	(*)	6355N	(*)	
XV950	14' - 21'	9615N	(*)	9616N	(*)	
XV950R	14' - 21'	9615N	(*)	9616N	(*)	
XV950 RACER	14' - 21'	9615N	(*)	9616N	(*)	
X-MAX 125	10' - 21'			6357N	(*)	
X-MAX 250	10' - 16'			6357N	(*)	
X-MAX 300	17' - 21'			6357N	(*)	
X-MAX 400	13' - 21'			6357N	(*)	
XSR 125	21'	6454N	(*)	6357N	(*)	
XSR700	16' - 21'	6456N	(*)	6357N	(*)	
XSR700 XTRIBUTE	19' - 21'	6456N	(*)	6357N	(*)	
XSR900	16' - 21'	6456N	(*)	6357N	(*)	

2022		For the new 2022 motorcycle models check www.puig.tv				
MODEL	YEAR	ADAPTER BY PAIR RIDER	N	ADAPTER BY PAIR PASSENGER	N	
XT660Z TÉNÉRÉ	08' - 16'	7282N	(*)	6359N	(*)	
XT1200Z SUPER TÉNÉRÉ	10' - 17'	3661N	(*)			
XT1200Z SUPER TÉNÉRÉ	18' - 21'	3661N	(*)	6357N	(*)	
XT1200ZE SUPER TENERE	19' - 21'	3661N	(*)	6357N	(*)	
YZF-R125	08' - 21'	6454N	(*)	6357N	(*)	
YZF-R1	02' - 21'	6457N	(*)	6458N	(*)	
YZF-R1M	17' - 21'	6457N	(*)	6458N	(*)	
YZF-R3	15' - 21'	6454N	(*)	6357N	(*)	
YZF-R6	03' - 20'	6457N	(*)	6458N	(*)	

N Black

NOTE: TO MOUNT PUIG FOOTPEGS, WE USE PARTS OF OEM FOOTPEGS.

(*) Check price with your distributor.

IMPORTANT: Indicate code color after part#. Example 0973A.

FOOTPEGS ADAPTORS WITH RELOCATION

HI-TECH PARTS

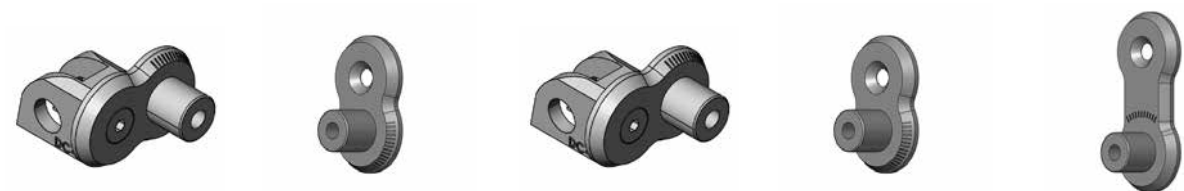

2022											
For the new 2022 motorcycle models check www.puig.tv											
MODEL	YEAR	RIDER ADJUSTABLE ADAPTOR KIT	N	RIDER RELOCATION BRACKETS SET 20 mm.	N	PASSENGER ADJUSTABLE ADAPTOR KIT	N	PASSENGER RELOCATION BRACKETS SET 20 mm.	N	PASSENGER RELOCATION BRACKETS SET 40 mm	N
APRILIA											
DORSODURO 900	17' - 21'					20255N	(*)	3838N	(*)	3839N	(*)
SHIVER 750	07' - 16'	20237N	(*)	3838N	(*)						
SHIVER 900	17' - 21'	20237N	(*)	3838N	(*)	20255N	(*)	3838N	(*)	3839N	(*)
SRV850	12' - 16'										
TUONO 660	21'	20237N	(*)	3838N	(*)						
BMW											
F650 GS	08' - 12'	20321N	(*)	3838N	(*)	20326N	(*)	3838N	(*)	3839N	(*)
F700 GS	12' - 17'	20321N	(*)	3838N	(*)	20326N	(*)	3838N	(*)	3839N	(*)
F750 GS	18' - 21'	20244N	(*)	3838N	(*)	20256N	(*)	3838N	(*)	3839N	(*)
F800 GT	13' - 20'					20305N	(*)	3838N	(*)	3839N	(*)
F800 GS	08' - 17'	20321N	(*)	3838N	(*)	20326N	(*)	3838N	(*)	3839N	(*)
F800 GS ADVENTURE	13' - 18'	20321N	(*)	3838N	(*)	20326N	(*)	3838N	(*)	3839N	(*)
F850 GS	18' - 21'	20244N	(*)	3838N	(*)	20256N	(*)	3838N	(*)	3839N	(*)
F850 GS ADVENTURE	19' - 21'	20247N	(*)	3838N	(*)	20256N	(*)	3838N	(*)	3839N	(*)
F900 R	20' - 21'	20304N	(*)	3838N	(*)	20305N	(*)	3838N	(*)	3839N	(*)
F900 XR	20' - 21'	20304N	(*)	3838N	(*)	20305N	(*)	3838N	(*)	3839N	(*)
R1200 GS	04' - 12'	20322N	(*)	3838N	(*)						
R1200 GS	13' - 16'	20244N	(*)	3838N	(*)	20275N	(*)	3838N	(*)	3839N	(*)
R1200 GS	17' - 18'	20244N	(*)	3838N	(*)	20275N	(*)	3838N	(*)	3839N	(*)
R1200 GS RALLYE	17' - 18'	20247N	(*)	3838N	(*)	20275N	(*)	3838N	(*)	3839N	(*)
R1200 GS EXCLUSIVE	17' - 18'	20244N	(*)	3838N	(*)	20275N	(*)	3838N	(*)	3839N	(*)
R1200GS ADVENTURE	14' - 18'					20275N	(*)	3838N	(*)	3839N	(*)
R1200 R	15' - 18'	20304N	(*)	3838N	(*)	20305N	(*)	3838N	(*)	3839N	(*)
R1200 RS	15' - 18'	20304N	(*)	3838N	(*)	20305N	(*)	3838N	(*)	3839N	(*)
R1250 GS	18' - 21'	20244N	(*)	3838N	(*)	20275N	(*)	3838N	(*)	3839N	(*)
R1250 GS ADVENTURE	18' - 20'	20247N	(*)	3838N	(*)	20275N	(*)	3838N	(*)	3839N	(*)
R1250 GS HP	18' - 21'	20247N	(*)	3838N	(*)	20275N	(*)	3838N	(*)	3839N	(*)
R1250 GS RALLYE	18' - 21'	20247N	(*)	3838N	(*)	20275N	(*)	3838N	(*)	3839N	(*)
R1250 R	19' - 21'	20304N	(*)	3838N	(*)	20305N	(*)	3838N	(*)	3839N	(*)
R1250 RS	19' - 21'	20304N	(*)	3838N	(*)	20305N	(*)	3838N	(*)	3839N	(*)

2022											
For the new 2022 motorcycle models check www.puig.tv											
MODEL	YEAR	RIDER ADJUSTABLE ADAPTOR KIT	N	RIDER RELOCATION BRACKETS SET 20 mm.	N	PASSENGER ADJUSTABLE ADAPTOR KIT	N	PASSENGER RELOCATION BRACKETS SET 20 mm.	N	PASSENGER RELOCATION BRACKETS SET 40 mm	N
R NINE T	14' - 20'	20304N	(*)	3838N	(*)	20305N	(*)	3838N	(*)	3839N	(*)
R NINE T	21'					20305N	(*)	3838N	(*)	3839N	(*)
R NINE T SCRAMBLER	16' - 21'					20305N	(*)	3838N	(*)	3839N	(*)
R NINE T PURE	17' - 21'	20304N	(*)	3838N	(*)	20305N	(*)	3838N	(*)	3839N	(*)
R NINE T RACER	17' - 20'	20317N	(*)	3838N	(*)						
R NINE T RACER	21'					20305N	(*)	3838N	(*)	3839N	(*)
R NINE T URBAN G/S	17' - 21'					20305N	(*)	3838N	(*)	3839N	(*)
S1000 R	14' - 21'	20317N	(*)	3838N	(*)						
S1000RR	09' - 21'	20317N	(*)	3838N	(*)						
S1000 XR	15' - 19'	20244N	(*)	3838N	(*)	20275N	(*)	3838N	(*)	3839N	(*)
S1000 XR	20' - 21'	20304N	(*)	3838N	(*)	20305N	(*)	3838N	(*)	3839N	(*)
DUCATI											
848	08' - 13'	20324N	(*)	3838N	(*)	20324N	(*)	3838N	(*)	3839N	(*)
899 PANIGALE	14' - 15'	20324N	(*)	3838N	(*)	20324N	(*)	3838N	(*)	3839N	(*)
959 PANIGALE	16' - 19'	20324N	(*)	3838N	(*)	20324N	(*)	3838N	(*)	3839N	(*)
1199 PANIGALE	12' - 14'	20324N	(*)	3838N	(*)	20324N	(*)	3838N	(*)	3839N	(*)
1199 SUPERLEGGERA	14'	20324N	(*)	3838N	(*)	20324N	(*)	3838N	(*)	3839N	(*)
1299 PANIGALE/S	15' - 17'	20324N	(*)	3838N	(*)	20324N	(*)	3838N	(*)	3839N	(*)
PANIGALE V2	20' - 21'	20324N	(*)	3838N	(*)	20324N	(*)	3838N	(*)	3839N	(*)
PANIGALE V2 BAYLISS	21'	20324N	(*)	3838N	(*)	20324N	(*)	3838N	(*)	3839N	(*)
PANIGALE 1100 V4	18' - 21'	20324N	(*)	3838N	(*)						
PANIGALE 1100 V4S	18' - 21'	20324N	(*)	3838N	(*)						
HYPERMOTARD 821/SP	13' - 15'	20323N	(*)	3838N	(*)	20323N	(*)	3838N	(*)	3839N	(*)
HYPERMOTARD 939/SP	16' - 18'	20323N	(*)	3838N	(*)	20323N	(*)	3838N	(*)	3839N	(*)
HYPERMOTARD 950/SP	19' - 21'	20242N	(*)	3838N	(*)	20242N	(*)	3838N	(*)	3839N	(*)
HYPERMOTARD 950 RVE	21'	20242N	(*)	3838N	(*)	20242N	(*)	3838N	(*)	3839N	(*)
HYPERSTRADA	13' - 15'	20323N	(*)	3838N	(*)	20323N	(*)	3838N	(*)	3839N	(*)
MONSTER 797	17' - 20'	20242N	(*)	3838N	(*)	20242N	(*)	3838N	(*)	3839N	(*)
MONSTER 1200 R	16' - 20'	20324N	(*)	3838N	(*)						
MULTISTRADA 950	17' - 21'	20277N	(*)	3838N	(*)	20277N	(*)	3838N	(*)	3839N	(*)
MULTISTRADA 1200/ S	10' - 14'	20323N	(*)	3838N	(*)	20323N	(*)	3838N	(*)	3839N	(*)
MULTISTRADA 1200/S	15' - 17'	20323N	(*)	3838N	(*)	20323N	(*)	3838N	(*)	3839N	(*)
MULTISTRADA 1200 PIKES PEAK	16' - 17'	20323N	(*)	3838N	(*)	20323N	(*)	3838N	(*)	3839N	(*)
MULTISTRADA 1260/S/S DJAIR	18' - 20'	20277N	(*)	3838N	(*)	20277N	(*)	3838N	(*)	3839N	(*)
MULTISTRADA 1260 PIKES PEAK	18' - 20'	20277N	(*)	3838N	(*)	20277N	(*)	3838N	(*)	3839N	(*)
MULTISTRADA 1260 ENDURO	18' - 21'					20277N	(*)	3838N	(*)	3839N	(*)

NOTE: TO MOUNT PUIG FOOTPEGS, WE USE PARTS OF OEM FOOTPEGS.

(*) Check price with your distributor.

IMPORTANT: Indicate code color after part#. Example 0973A.



FOOTPEGS ADAPTORS WITH RELOCATION

HI-TECH PARTS

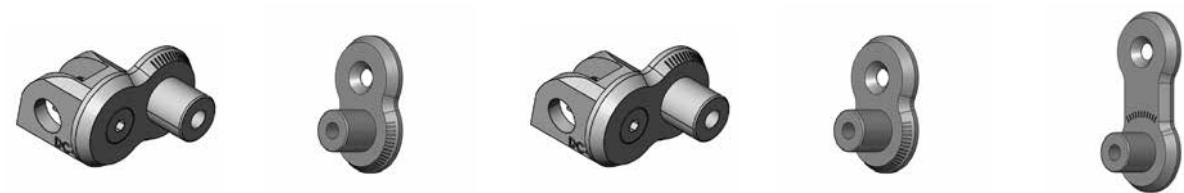

2022											
For the new 2022 motorcycle models check www.puig.tv											
MODEL	YEAR	RIDER ADJUSTABLE ADAPTOR KIT	N	RIDER RELOCATION BRACKETS SET 20 mm.	N	PASSENGER ADJUSTABLE ADAPTOR KIT	N	PASSENGER RELOCATION BRACKETS SET 20 mm.	N	PASSENGER RELOCATION BRACKETS SET 40 mm	N
MULTISTRADA V4	21'	20270N	(*)	3838N	(*)						
MULTISTRADA V4S/S SPORT	21'	20270N	(*)	3838N	(*)						
SCRAMBLER ICON/CLASSIC/FULL THROTTLE	15' - 21'	20242N	(*)	3838N	(*)	20242N	(*)	3838N	(*)	3839N	(*)
SCRAMBLER SIXTY2	16' - 21'	20242N	(*)	3838N	(*)	20242N	(*)	3838N	(*)	3839N	(*)
SCRAMBLER URBAN ENDURO	15' - 16'	20242N	(*)	3838N	(*)	20242N	(*)	3838N	(*)	3839N	(*)
SCRAMBLER FLAT TRACK PRO	16'	20242N	(*)	3838N	(*)	20242N	(*)	3838N	(*)	3839N	(*)
SCRAMBLER DESERT SLED	17' - 20'					20277N	(*)	3838N	(*)	3839N	(*)
SCRAMBLER CAFE RACER	17' - 21'	20242N	(*)	3838N	(*)	20242N	(*)	3838N	(*)	3839N	(*)
STREETFIGHTER 848	12' - 15'	20324N	(*)	3838N	(*)	20324N	(*)	3838N	(*)	3839N	(*)
STREETFIGHTER V4/S	20' - 21'	20324N	(*)	3838N	(*)	20324N	(*)	3838N	(*)	3839N	(*)
SUPERSPORT 939/S	17' - 20'	20242N	(*)	3838N	(*)	20242N	(*)	3838N	(*)	3839N	(*)
SUPERSPORT 950/S	21'					20242N	(*)	3838N	(*)	3839N	(*)
HONDA											
CB125R NEO SPORTS CAFE	18' - 21'	20318N	(*)	3838N	(*)	20252N	(*)	3838N	(*)	3839N	(*)
CB300R NEO SPORTS CAFE	18' - 21'	20318N	(*)	3838N	(*)	20252N	(*)	3838N	(*)	3839N	(*)
CB500F	13' - 15'	20241N	(*)	3838N	(*)	20254N	(*)	3838N	(*)	3839N	(*)
CB500F	16' - 21'	20241N	(*)	3838N	(*)	20252N	(*)	3838N	(*)	3839N	(*)
CB500X	13' - 21'	20241N	(*)	3838N	(*)	20254N	(*)	3838N	(*)	3839N	(*)
CB600F HORNET	02' - 06'	20318N	(*)	3838N	(*)						
CB600F HORNET	07' - 15'	20318N	(*)	3838N	(*)						
CB650F	14' - 20'	20318N	(*)	3838N	(*)	20252N	(*)	3838N	(*)	3839N	(*)
CB650R NEO SPORTS CAFE	19' - 21'	20318N	(*)	3838N	(*)	20252N	(*)	3838N	(*)	3839N	(*)
CB1000R NEO SPORTS CAFE	18' - 21'	20318N	(*)	3838N	(*)	20252N	(*)	3838N	(*)	3839N	(*)
CB1000R BLACK EDITION	21'	20318N	(*)	3838N	(*)	20252N	(*)	3838N	(*)	3839N	(*)
CB1000R	08' - 16'	20318N	(*)	3838N	(*)						
CB1100	13' - 14'	20248N	(*)	3838N	(*)	20253N	(*)	3838N	(*)	3839N	(*)
CB1100RS	17' - 21'	20236N	(*)	3838N	(*)	20252N	(*)	3838N	(*)	3839N	(*)
CB1100EX	17' - 21'	20236N	(*)	3838N	(*)	20252N	(*)	3838N	(*)	3839N	(*)
CMX 500 REBEL	17' - 21'					20252N	(*)	3838N	(*)	3839N	(*)
CMX 500 REBEL S	20' - 21'					20252N	(*)	3838N	(*)	3839N	(*)

2022											
For the new 2022 motorcycle models check www.puig.tv											
MODEL	YEAR	RIDER ADJUSTABLE ADAPTOR KIT	N	RIDER RELOCATION BRACKETS SET 20 mm.	N	PASSENGER ADJUSTABLE ADAPTOR KIT	N	PASSENGER RELOCATION BRACKETS SET 20 mm.	N	PASSENGER RELOCATION BRACKETS SET 40 mm	N
CBF600	04' - 14'	20318N	(*)	3838N	(*)						
CBF600S	08' - 14'	20318N	(*)	3838N	(*)						
CBF1000	06' - 11'	20318N	(*)	3838N	(*)						
CBR250R	11' - 14'	20318N	(*)	3838N	(*)	20254N	(*)	3838N	(*)	3839N	(*)
CBR500R	13' - 15'	20241N	(*)	3838N	(*)	20254N	(*)	3838N	(*)	3839N	(*)
CBR500R	16' - 21'	20241N	(*)	3838N	(*)	20252N	(*)	3838N	(*)	3839N	(*)
CBR600F	01' - 13'	20318N	(*)	3838N	(*)						
CBR600RR	03' - 16'	20318N	(*)	3838N	(*)						
CBR650F	14' - 19'	20318N	(*)	3838N	(*)	20252N	(*)	3838N	(*)	3839N	(*)
CBR650R	19' - 21'	20318N	(*)	3838N	(*)	20252N	(*)	3838N	(*)	3839N	(*)
CBR900RR FIRE BLADE	00' - 01'	20318N	(*)	3838N	(*)						
CBR900RR FIRE BLADE	02' - 03'	20318N	(*)	3838N	(*)						
CBR1000RR FIREBLADE	04' - 13'	20318N	(*)	3838N	(*)						
CBR1000RR FIREBLADE/SP	14' - 16'	20318N	(*)	3838N	(*)						
CBR1000RR FIREBLADE/SP/SP2	17' - 19'	20241N	(*)	3838N	(*)						
CBR1000RR FIREBLADE/SP	20' - 21'					20252N	(*)	3838N	(*)	3839N	(*)
CROSSRUNNER	15' - 21'	20241N	(*)	3838N	(*)	20252N	(*)	3838N	(*)	3839N	(*)
CROSSTOURER	12' - 21'	20241N	(*)	3838N	(*)						
INTEGRA 700	12' - 13'					20252N	(*)	3838N	(*)	3839N	(*)
INTEGRA 750	14' - 21'					20252N	(*)	3838N	(*)	3839N	(*)
INTEGRA 750S	14' - 16'					20252N	(*)	3838N	(*)	3839N	(*)
MONKEY 125	18' - 21'	20241N	(*)	3838N	(*)						
MSX125	14' - 20'	20318N	(*)	3838N	(*)						
NC700S/X	12' - 13'	20236N	(*)	3838N	(*)	20252N	(*)	3838N	(*)	3839N	(*)
NC750S/X	14' - 15'	20236N	(*)	3838N	(*)	20252N	(*)	3838N	(*)	3839N	(*)
NC750S/X	16' - 21'	20241N	(*)	3838N	(*)	20252N	(*)	3838N	(*)	3839N	(*)
VFR800F	14' - 20'	20241N	(*)	3838N	(*)	20252N	(*)	3838N	(*)	3839N	(*)
VFR1200F	10' - 16'	20236N	(*)	3838N	(*)						
VTR1000 SP-1	00' - 02'	20318N	(*)	3838N	(*)						
VTR1000 SP-2	02' - 05'	20318N	(*)	3838N	(*)						
KAWASAKI											
ER-6F	06' - 16'	20233N	(*)	3838N	(*)	20250N	(*)	3838N	(*)	3839N	(*)
ER-6N	05' - 16'	20233N	(*)	3838N	(*)	20250N	(*)	3838N	(*)	3839N	(*)
NINJA 125	19' - 21'	20233N	(*)	3838N	(*)						
NINJA 250R	08' - 12'	20233N	(*)	3838N	(*)						
NINJA 250SL	15' - 16'	20233N	(*)	3838N	(*)						

NOTE: TO MOUNT PUIG FOOTPEGS, WE USE PARTS OF OEM FOOTPEGS.

(*) Check price with your distributor.

IMPORTANT: Indicate code color after part#. Example 0973A.



FOOTPEGS ADAPTORS WITH RELOCATION

HI-TECH PARTS

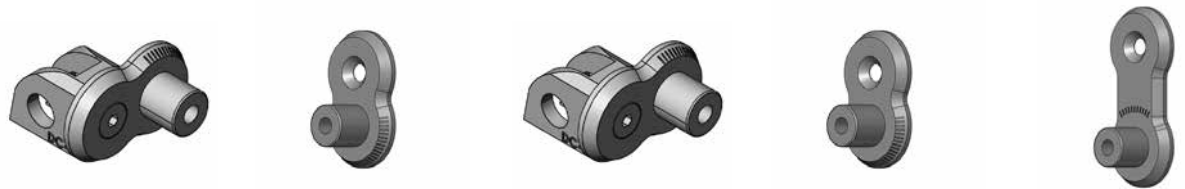

2022											
For the new 2022 motorcycle models check www.puig.tv											
MODEL	YEAR	RIDER ADJUSTABLE ADAPTOR KIT	N	RIDER RELOCATION BRACKETS SET 20 mm.	N	PASSENGER ADJUSTABLE ADAPTOR KIT	N	PASSENGER RELOCATION BRACKETS SET 20 mm.	N	PASSENGER RELOCATION BRACKETS SET 40 mm	N
NINJA 300	13' - 17'	20233N	(*)	3838N	(*)						
NINJA 400	18' - 21'	20319N	(*)	3838N	(*)	20250N	(*)	3838N	(*)	3839N	(*)
NINJA 650	17' - 21'	20233N	(*)	3838N	(*)	20250N	(*)	3838N	(*)	3839N	(*)
NINJA 1000 SX	20' - 21'	20235N	(*)	3838N	(*)	20250N	(*)	3838N	(*)	3839N	(*)
NINJA H2 SX	18' - 21'	20235N	(*)	3838N	(*)	20250N	(*)	3838N	(*)	3839N	(*)
VERSYS-X 300	17' - 20'	20233N	(*)	3838N	(*)						
VERSYS 650	10' - 21'	20233N	(*)	3838N	(*)	20250N	(*)	3838N	(*)	3839N	(*)
VERSYS 1000	12' - 20'	20233N	(*)	3838N	(*)	20250N	(*)	3838N	(*)	3839N	(*)
Z125	17' - 21'	20233N	(*)	3838N	(*)						
Z250SL	15' - 16'	20233N	(*)	3838N	(*)						
Z300	15' - 17'	20233N	(*)	3838N	(*)						
Z400	19' - 21'	20319N	(*)	3838N	(*)	20250N	(*)	3838N	(*)	3839N	(*)
Z650	17' - 21'	20233N	(*)	3838N	(*)	20250N	(*)	3838N	(*)	3839N	(*)
Z750	04' - 12'	20235N	(*)	3838N	(*)	20250N	(*)	3838N	(*)	3839N	(*)
Z750R	11' - 12'	20272N	(*)	3838N	(*)	20250N	(*)	3838N	(*)	3839N	(*)
Z800	13' - 16'	20272N	(*)	3838N	(*)	20250N	(*)	3838N	(*)	3839N	(*)
Z800E	13' - 16'	20272N	(*)	3838N	(*)	20250N	(*)	3838N	(*)	3839N	(*)
Z900	17' - 21'	20233N	(*)	3838N	(*)	20250N	(*)	3838N	(*)	3839N	(*)
Z900RS	18' - 21'	20233N	(*)	3838N	(*)	20250N	(*)	3838N	(*)	3839N	(*)
Z900RS CAFÉ	18' - 21'	20233N	(*)	3838N	(*)	20250N	(*)	3838N	(*)	3839N	(*)
Z1000	03' - 09'	20235N	(*)	3838N	(*)	20250N	(*)	3838N	(*)	3839N	(*)
Z1000	10' - 13'	20272N	(*)	3838N	(*)	20250N	(*)	3838N	(*)	3839N	(*)
Z1000	14' - 21'	20272N	(*)	3838N	(*)	20250N	(*)	3838N	(*)	3839N	(*)
Z1000R	17' - 21'	20272N	(*)	3838N	(*)	20250N	(*)	3838N	(*)	3839N	(*)
Z1000SX	17' - 19'	20235N	(*)	3838N	(*)	20250N	(*)	3838N	(*)	3839N	(*)
ZH2	20' - 21'	20272N	(*)	3838N	(*)	20250N	(*)	3838N	(*)	3839N	(*)
Z H2 SE	20' - 21'	20272N	(*)	3838N	(*)	20250N	(*)	3838N	(*)	3839N	(*)
ZX-6R	03' - 16'	20272N	(*)	3838N	(*)	20250N	(*)	3838N	(*)	3839N	(*)
ZX-6R	18' - 21'	20272N	(*)	3838N	(*)	20250N	(*)	3838N	(*)	3839N	(*)
ZX-6R 636	13' - 16'	20272N	(*)	3838N	(*)	20250N	(*)	3838N	(*)	3839N	(*)
ZX-10R	04' - 10'	20272N	(*)	3838N	(*)	20250N	(*)	3838N	(*)	3839N	(*)

2022											
For the new 2022 motorcycle models check www.puig.tv											
MODEL	YEAR	RIDER ADJUSTABLE ADAPTOR KIT	N	RIDER RELOCATION BRACKETS SET 20 mm.	N	PASSENGER ADJUSTABLE ADAPTOR KIT	N	PASSENGER RELOCATION BRACKETS SET 20 mm.	N	PASSENGER RELOCATION BRACKETS SET 40 mm	N
ZX-10R	11' - 15'					20250N	(*)	3838N	(*)	3839N	(*)
ZX-10R	16' - 20'	20319N	(*)	3838N	(*)	20250N	(*)	3838N	(*)	3839N	(*)
ZX-10R	21'	20319N	(*)	3838N	(*)	20250N	(*)	3838N	(*)	3839N	(*)
ZX-10RR	17' - 20'	20319N	(*)	3838N	(*)	20250N	(*)	3838N	(*)	3839N	(*)
ZX-10RR	21'	20319N	(*)	3838N	(*)	20250N	(*)	3838N	(*)	3839N	(*)
ZX-10R SE	18' - 20'	20319N	(*)	3838N	(*)	20250N	(*)	3838N	(*)	3839N	(*)
ZZR1400	12' - 21'	20235N	(*)	3838N	(*)	20250N	(*)	3838N	(*)	3839N	(*)
KTM											
125 DUKE	11' - 16'	20237N	(*)	3838N	(*)						
125 DUKE	17' - 21'	20237N	(*)	3838N	(*)						
200 DUKE	12' - 15'	20237N	(*)	3838N	(*)						
390 DUKE	13' - 16'	20237N	(*)	3838N	(*)						
390 DUKE	17' - 21'	20237N	(*)	3838N	(*)						
790 ADVENTURE/R	19' - 21'	20245N	(*)	3838N	(*)	20257N	(*)	3838N	(*)	3839N	(*)
890 ADVENTURE	21'	20245N	(*)	3838N	(*)	20257N	(*)	3838N	(*)	3839N	(*)
990 SUPERMOTO	08' - 13'	20245N	(*)	3838N	(*)	20258N	(*)	3838N	(*)	3839N	(*)
1050 ADVENTURE	15' - 16'	20245N	(*)	3838N	(*)	20258N	(*)	3838N	(*)	3839N	(*)
1090 ADVENTURE /R	17' - 20'	20245N	(*)	3838N	(*)	20258N	(*)	3838N	(*)	3839N	(*)
1190 ADVENTURE/R	13' - 16'	20245N	(*)	3838N	(*)	20258N	(*)	3838N	(*)	3839N	(*)
1290 SUPER ADVENTURE	15' - 16'	20245N	(*)	3838N	(*)	20258N	(*)	3838N	(*)	3839N	(*)
1290 SUPER ADVENTURE R	17' - 20'	20245N	(*)	3838N	(*)	20258N	(*)	3838N	(*)	3839N	(*)
1290 SUPER ADVENTURE S	17' - 20'	20245N	(*)	3838N	(*)	20258N	(*)	3838N	(*)	3839N	(*)
1290 SUPER ADVENTURE R/S	21'	20245N	(*)	3838N	(*)	20257N	(*)	3838N	(*)	3839N	(*)
1290 SUPER ADVENTURE T	17' - 20'	20245N	(*)	3838N	(*)	20258N	(*)	3838N	(*)	3839N	(*)
1290 SUPERDUKE R	20' - 21'	20453N	(*)	3838N	(*)	20455N	(*)	3838N	(*)	3839N	(*)
SUZUKI											
B-KING	08' - 11'	20234N	(*)	3838N	(*)						
DL250 V-STROM	17' - 21'	20234N	(*)	3838N	(*)						
DL650 V-STROM	04' - 21'	20238N	(*)	3838N	(*)						
DL650XT V-STROM	15' - 21'	20238N	(*)	3838N	(*)						
DL1000 V-STROM	14' - 19'	20238N	(*)	3838N	(*)						
DL1000XT V-STROM	17' - 19'	20238N	(*)	3838N	(*)						
DL1050 V-STROM	20' - 21'	20406N	(*)	3838N	(*)	20407N	(*)	3838N	(*)	3839N	(*)
DL1050XT V-STROM	20' - 21'	20406N	(*)	3838N	(*)	20407N	(*)	3838N	(*)	3839N	(*)
GSR600	06' - 11'	20234N	(*)	3838N	(*)						
GSR750	11' - 16'	20234N	(*)	3838N	(*)						

NOTE: TO MOUNT PUIG FOOTPEGS, WE USE PARTS OF OEM FOOTPEGS.

(*) Check price with your distributor.

IMPORTANT: Indicate code color after part#. Example 0973A.



FOOTPEGS ADAPTORS WITH RELOCATION

HI-TECH PARTS

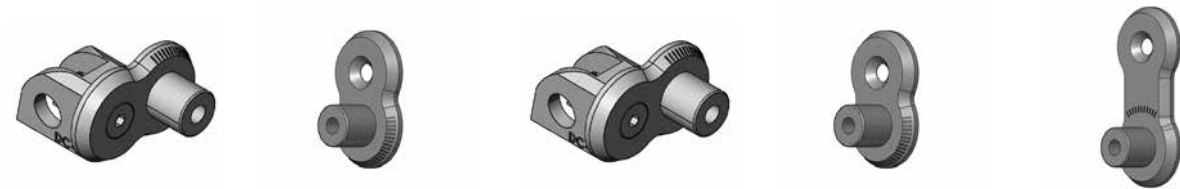

2022											
For the new 2022 motorcycle models check www.puig.tv											
MODEL	YEAR	RIDER ADJUSTABLE ADAPTOR KIT	N	RIDER RELOCATION BRACKETS SET 20 mm.	N	PASSENGER ADJUSTABLE ADAPTOR KIT	N	PASSENGER RELOCATION BRACKETS SET 20 mm.	N	PASSENGER RELOCATION BRACKETS SET 40 mm	N
GSX-R125	17' - 21'	20234N	(*)	3838N	(*)						
GSX-R250	17' - 21'	20238N	(*)	3838N	(*)						
GSX-R600	01' - 05'	20233N	(*)	3838N	(*)						
GSX-R600	06' - 16'	20234N	(*)	3838N	(*)						
GSX-R750	01' - 05'	20233N	(*)	3838N	(*)						
GSX-R750	06' - 16'	20234N	(*)	3838N	(*)						
GSX-R1000	01' - 04'	20234N	(*)	3838N	(*)						
GSX-R1000	05' - 16'	20234N	(*)	3838N	(*)						
GSX-R1000/R	17' - 20'	20234N	(*)	3838N	(*)	20273N	(*)	3838N	(*)	3839N	(*)
GSX-S125	17' - 21'	20234N	(*)	3838N	(*)						
GSX-S750	17' - 21'	20234N	(*)	3838N	(*)	20273N	(*)	3838N	(*)	3839N	(*)
GSX-S950	22'	20234N	(*)	3838N	(*)	20520N	(*)	3838N	(*)	3839N	(*)
GSX-S1000	15' - 22'	20234N	(*)	3838N	(*)	20520N	(*)	3838N	(*)	3839N	(*)
GSX-S1000F	15' - 21'	20234N	(*)	3838N	(*)	20520N	(*)	3838N	(*)	3839N	(*)
INAZUMA	13' - 17'	20238N	(*)	3838N	(*)						
KATANA	19' - 21'	20234N	(*)	3838N	(*)	20273N	(*)	3838N	(*)	3839N	(*)
SFV650 GLADIUS	09' - 15'	20234N	(*)	3838N	(*)						
SV650S	03' - 08'	20233N	(*)	3838N	(*)						
SV650	16' - 21'	20234N	(*)	3838N	(*)						
SV650X	18' - 21'	20234N	(*)	3838N	(*)						
SV1000S	03' - 05'	20233N	(*)	3838N	(*)						
TRIUMPH											
BONNEVILLE T100/T120	16' - 19'	20320N	(*)	3838N	(*)						
BONNEVILLE BOBBER	17' - 21'	20320N	(*)	3838N	(*)						
BONNEVILLE BOBBER BLACK	20' - 21'	20320N	(*)	3838N	(*)						
DAYTONA 675	09' - 17'	20320N	(*)	3838N	(*)						
DAYTONA 675 R	11' - 17'	20320N	(*)	3838N	(*)						
SCRAMBLER 1200XC	19' - 21'	20246N	(*)	3838N	(*)						
SCRAMBLER 1200XE	19' - 21'	20246N	(*)	3838N	(*)						
SPEED TRIPLE	11' - 15'	20320N	(*)	3838N	(*)						
SPEED TRIPLE/R	16' - 20'	20320N	(*)	3838N	(*)						

2022											
For the new 2022 motorcycle models check www.puig.tv											
MODEL	YEAR	RIDER ADJUSTABLE ADAPTOR KIT	N	RIDER RELOCATION BRACKETS SET 20 mm.	N	PASSENGER ADJUSTABLE ADAPTOR KIT	N	PASSENGER RELOCATION BRACKETS SET 20 mm.	N	PASSENGER RELOCATION BRACKETS SET 40 mm	N
SPEED TWIN	19' - 21'	20320N	(*)	3838N	(*)						
STREET CUP	17' - 20'	20320N	(*)	3838N	(*)						
STREET SCRAMBLER	17' - 21'	20246N	(*)	3838N	(*)						
STREET TRIPLE	08' - 19'	20320N	(*)	3838N	(*)						
STREET TRIPLE R	09' - 21'	20320N	(*)	3838N	(*)						
STREET TRIPLE S	17' - 21'	20320N	(*)	3838N	(*)						
STREET TRIPLE RS	17' - 19'	20320N	(*)	3838N	(*)						
STREET TWIN	16' - 21'	20320N	(*)	3838N	(*)						
THRUXTON 1200/R	16' - 20'	20320N	(*)	3838N	(*)						
THRUXTON 1200RS	20' - 21'	20320N	(*)	3838N	(*)						
TRIDENT 660	21'	20320N	(*)	3838N	(*)						
TIGER 800	11' - 14'	20246N	(*)	3838N	(*)	20259N	(*)	3838N	(*)	3839N	(*)
TIGER 800 XC	11' - 14'	20246N	(*)	3838N	(*)	20259N	(*)	3838N	(*)	3839N	(*)
TIGER 800 XC/XC/XCA	15' - 20'	20246N	(*)	3838N	(*)	20259N	(*)	3838N	(*)	3839N	(*)
TIGER 800 XR/XRX/XRT	15' - 20'	20246N	(*)	3838N	(*)	20259N	(*)	3838N	(*)	3839N	(*)
TIGER 900	20' - 21'	20387N	(*)	3838N	(*)						
TIGER 900 GT	20' - 21'	20387N	(*)	3838N	(*)						
TIGER 900 GT LOW	20' - 21'	20387N	(*)	3838N	(*)						
TIGER 900 GT PRO	20' - 21'	20387N	(*)	3838N	(*)						
TIGER 900 RALLY	20' - 21'	20387N	(*)	3838N	(*)						
TIGER 900 RALLY PRO	20' - 21'	20387N	(*)	3838N	(*)						
TIGER SPORT	13' - 20'	20320N	(*)	3838N	(*)						
YAMAHA											
FJR1300A/AS	13' - 19'	20248N	(*)	3838N	(*)						
FZ1	06' - 15'					20253N	(*)	3838N	(*)	3839N	(*)
FZ1 FAZER	06' - 15'					20253N	(*)	3838N	(*)	3839N	(*)
FZ6	04' - 08'	20248N	(*)	3838N	(*)						
FZ6 FAZER	07' - 08'	20248N	(*)	3838N	(*)						
FZ6 FAZER S2	07' - 10'	20248N	(*)	3838N	(*)						
FZS1000 FAZER	01' - 05'					20253N	(*)	3838N	(*)	3839N	(*)
MT-125	14' - 21'	20239N	(*)	3838N	(*)	20253N	(*)	3838N	(*)	3839N	(*)
MT-03	16' - 21'	20239N	(*)	3838N	(*)	20253N	(*)	3838N	(*)	3839N	(*)
MT-07	14' - 21'	20248N	(*)	3838N	(*)	20253N	(*)	3838N	(*)	3839N	(*)
MT-07 TRACER	16' - 19'	20248N	(*)	3838N	(*)						
MT-07 TRACER	20' - 21'	20248N	(*)	3838N	(*)	20446N	(*)	3838N	(*)	3839N	(*)
MT-07 TRACER GT	19'	20248N	(*)	3838N	(*)						

NOTE: TO MOUNT PUIG FOOTPEGS, WE USE PARTS OF OEM FOOTPEGS.

(*) Check price with your distributor.

IMPORTANT: Indicate code color after part#. Example 0973A.



N Black

FOOTPEGS ADAPTORS WITH RELOCATION

HI-TECH PARTS

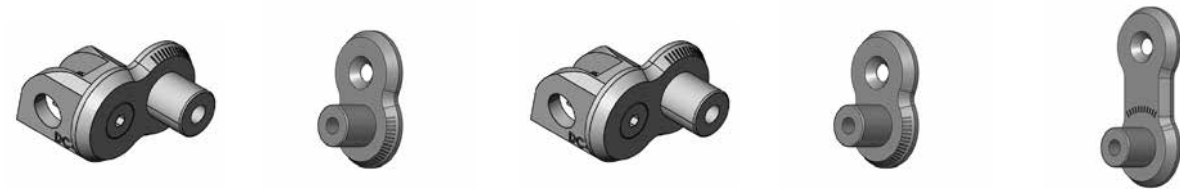

2022											
For the new 2022 motorcycle models check www.puig.tv											
MODEL	YEAR	RIDER ADJUSTABLE ADAPTOR KIT	N	RIDER RELOCATION BRACKETS SET 20 mm.	N	PASSENGER ADJUSTABLE ADAPTOR KIT	N	PASSENGER RELOCATION BRACKETS SET 20 mm.	N	PASSENGER RELOCATION BRACKETS SET 40 mm	N
MT-07 TRACER GT	20' - 21'	20248N	(*)	3838N	(*)	20446N	(*)	3838N	(*)	3839N	(*)
MT-09	13' - 16'	20248N	(*)	3838N	(*)	20253N	(*)	3838N	(*)	3839N	(*)
MT-09	17' - 20'	20248N	(*)	3838N	(*)	20253N	(*)	3838N	(*)	3839N	(*)
MT-09	21'	20675N	(*)	3838N	(*)	20674N	(*)	3838N	(*)	3839N	(*)
MT-09 SP	18' - 20'	20248N	(*)	3838N	(*)	20253N	(*)	3838N	(*)	3839N	(*)
MT-09 SP	21'	20675N	(*)	3838N	(*)	20674N	(*)	3838N	(*)	3839N	(*)
MT-09 TRACER	15' - 20'	20248N	(*)	3838N	(*)	20253N	(*)	3838N	(*)	3839N	(*)
MT-09 TRACER	21'	20675N	(*)	3838N	(*)	20839N	(*)	3838N	(*)	3839N	(*)
MT-09 TRACER GT	18' - 20'	20248N	(*)	3838N	(*)	20253N	(*)	3838N	(*)	3839N	(*)
MT-09 TRACER GT	21'	20675N	(*)	3838N	(*)	20839N	(*)	3838N	(*)	3839N	(*)
MT-10	16' - 21'					20253N	(*)	3838N	(*)	3839N	(*)
MT-10 SP	17' - 21'					20253N	(*)	3838N	(*)	3839N	(*)
NIKEN	18' - 21'	20248N	(*)	3838N	(*)	20253N	(*)	3838N	(*)	3839N	(*)
SCR950	17' - 21'	20248N	(*)	3838N	(*)						
TENERE 700	19' - 21'	20243N	(*)	3838N	(*)	20253N	(*)	3838N	(*)	3839N	(*)
T-MAX 500	08' - 11'					20249N	(*)	3838N	(*)	3839N	(*)
T-MAX 530	12' - 14'					20249N	(*)	3838N	(*)	3839N	(*)
T-MAX 530	15' - 16'					20249N	(*)	3838N	(*)	3839N	(*)
T-MAX 530/DX/SX	17' - 19'					20253N	(*)	3838N	(*)	3839N	(*)
T-MAX 560 /SX/DX/MAX TECH	20' - 21'					20253N	(*)	3838N	(*)	3839N	(*)
XJ6	09' - 16'	20248N	(*)	3838N	(*)	20249N	(*)	3838N	(*)	3839N	(*)
XJ6 DIVERSION	09' - 16'	20248N	(*)	3838N	(*)	20249N	(*)	3838N	(*)	3839N	(*)
XJ6 DIVERSION F	10' - 16'	20248N	(*)	3838N	(*)	20249N	(*)	3838N	(*)	3839N	(*)
X-MAX 125	10' - 21'					20253N	(*)	3838N	(*)	3839N	(*)
X-MAX 250	10' - 16'					20253N	(*)	3838N	(*)	3839N	(*)
X-MAX 300	17' - 21'					20253N	(*)	3838N	(*)	3839N	(*)
X-MAX 400	13' - 21'					20253N	(*)	3838N	(*)	3839N	(*)
XSR 125	21'	20239N	(*)	3838N	(*)	20253N	(*)	3838N	(*)	3839N	(*)
XSR700	16' - 21'	20248N	(*)	3838N	(*)	20253N	(*)	3838N	(*)	3839N	(*)
XSR700 XTRIBUTE	19' - 21'	20248N	(*)	3838N	(*)	20253N	(*)	3838N	(*)	3839N	(*)
XSR900	16' - 21'	20248N	(*)	3838N	(*)	20253N	(*)	3838N	(*)	3839N	(*)

2022											
For the new 2022 motorcycle models check www.puig.tv											
MODEL	YEAR	RIDER ADJUSTABLE ADAPTOR KIT	N	RIDER RELOCATION BRACKETS SET 20 mm.	N	PASSENGER ADJUSTABLE ADAPTOR KIT	N	PASSENGER RELOCATION BRACKETS SET 20 mm.	N	PASSENGER RELOCATION BRACKETS SET 40 mm	N
XT1200Z SUPER TENERÉ	18' - 21'					20253N	(*)	3838N	(*)	3839N	(*)
XT1200ZE SUPER TENERE	19' - 21'					20253N	(*)	3838N	(*)	3839N	(*)
YZF-R125	08' - 21'	20239N	(*)	3838N	(*)	20253N	(*)	3838N	(*)	3839N	(*)
YZF-R1	02' - 21'	20240N	(*)	3838N	(*)	20251N	(*)	3838N	(*)	3839N	(*)
YZF-R1M	17' - 21'	20240N	(*)	3838N	(*)	20251N	(*)	3838N	(*)	3839N	(*)
YZF-R3	15' - 21'	20239N	(*)	3838N	(*)	20253N	(*)	3838N	(*)	3839N	(*)
YZF-R6	03' - 20'	20240N	(*)	3838N	(*)	20251N	(*)	3838N	(*)	3839N	(*)

NOTE: TO MOUNT PUIG FOOTPEGS, WE USE PARTS OF OEM FOOTPEGS.

(*) Check price with your distributor.

IMPORTANT: Indicate code color after part#. Example 0973A.



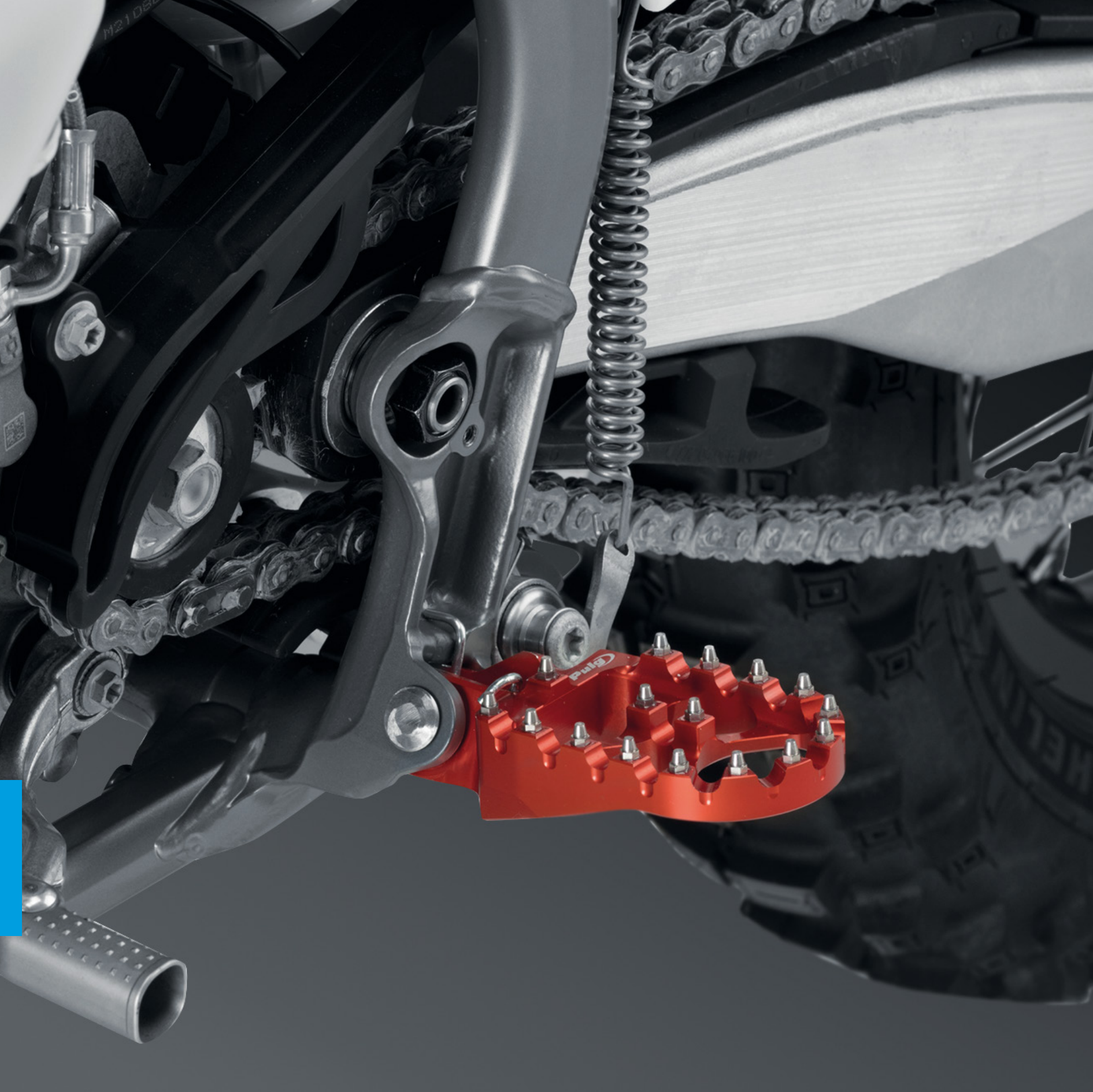

OFF-ROAD FOOTPEGS

HI-TECH PARTS | TECHNICAL SECTION

Puig
Off-Road

NEW!

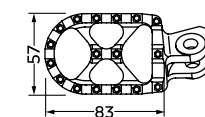

DIMENSIONS
83 x 57 mm.

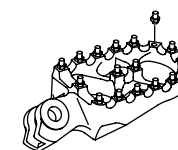

DESIGN
Maximum grip with replaceable tips.

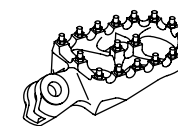



MODEL
A specific design for each bike.







WEIGHT
140 grams



OFF-ROAD MODEL	REF.
OFF-ROAD FOOTPEG SET WITH ADAPTORS	SEE PAGE 494

 A Blue
 R Red

 N Black
 V Green

 O Gold
 P Silver

 T Orange

(*) Check price with your distributor.
IMPORTANT: Indicate code color after part#. Example 0973A.

OFF-ROAD FOOTPEGS

HI-TECH PARTS

2022				
For the new 2022 motorcycle models check www.puig.tv				
MODEL	YEAR	REF.	A N O T R V P	
HONDA				
CR125R	02' - 07'	20555	(*)	
CR250R	02' - 07'	20555	(*)	
CRF150R	07' - 21'	20555	(*)	
CRF230F	03' - 19'	20555	(*)	
CRF250R	04' - 21'	20555	(*)	
CRF250RX	19' - 21'	20555	(*)	
CRF250X	04' - 21'	20555	(*)	
CRF450R	02' - 21'	20555	(*)	
CRF450L	19' - 20'	20555	(*)	
CRF450RX	17' - 20'	20555	(*)	
CRF450X	02' - 21'	20555	(*)	
CRF1000L AFRICA TWIN	16' - 19'	20555	(*)	
CRF1100L AFRICA TWIN	20' - 21'	20555	(*)	
HUSQVARNA				
TC125	14' - 15'	20562	(*)	
TC125	16' - 21'	20564	(*)	
FC250	14' - 15'	20562	(*)	
FC250	16' - 21'	20564	(*)	
FC450	14' - 15'	20562	(*)	
FC450	16' - 21'	20564	(*)	
TX300	17' - 21'	20564	(*)	
TX450	17' - 21'	20564	(*)	
FX300	17' - 21'	20564	(*)	
FX450	17' - 21'	20564	(*)	
TC250	14' - 16'	20562	(*)	
TC250	17' - 21'	20564	(*)	
TE150	14' - 16'	20562	(*)	
TE501	14' - 16'	20562	(*)	
FE150	17' - 21'	20564	(*)	
FE501	17' - 21'	20564	(*)	
KAWASAKI				
KX450	19' - 21'	20557	(*)	
KX250F	06' - 19'	20557	(*)	
KX450F	07' - 18'	20557	(*)	
KTM				
125SX	99' - 15'	20562	(*)	
125EXC	99' - 15'	20562	(*)	

2022				
For the new 2022 motorcycle models check www.puig.tv				
MODEL	YEAR	REF.	A N O T R V P	
144SX	08' - 15'	20562	(*)	
150SX	08' - 15'	20562	(*)	
200SX	98' - 15'	20562	(*)	
200EXC	98' - 15'	20562	(*)	
250SX	98' - 15'	20562	(*)	
250EXC	98' - 15'	20562	(*)	
250SX-F	06' - 15'	20562	(*)	
250EXC-F	06' - 15'	20562	(*)	
FREERIDE 250F	18' - 20'	20562	(*)	
300SX	98' - 15'	20562	(*)	
300EXC	98' - 15'	20562	(*)	
FREERIDE 350	12' - 17'	20562	(*)	
350SX-F	11' - 15'	20562	(*)	
350EXC-F	11' - 15'	20562	(*)	
400SX-F	98' - 12'	20562	(*)	
400EXC-F	98' - 12'	20562	(*)	
450SX-F	03' - 15'	20562	(*)	
450EXC-F	03' - 15'	20562	(*)	
500EXC-F	11' - 15'	20562	(*)	
505SX-F	08' - 12'	20562	(*)	
525SX-F	03' - 06'	20562	(*)	
525EXC-F	03' - 06'	20562	(*)	
125SX	16' - 21'	20564	(*)	
250SX-F	16' - 21'	20564	(*)	
250XC-F	16' - 21'	20564	(*)	
450SX-F	16' - 21'	20564	(*)	
450XC-F	16' - 21'	20564	(*)	
250SX	17' - 21'	20564	(*)	
125EXC	17' - 21'	20564	(*)	
125EXC-F	17' - 21'	20564	(*)	
530EXC	17' - 21'	20564	(*)	
530EXC-F	17' - 21'	20564	(*)	
150XC	17' - 21'	20564	(*)	
300XC	17' - 21'	20564	(*)	
790 ADVENTURE/R	19' - 21'	20564	(*)	
1090 ADVENTURE/R	17' - 20'	20564	(*)	
1190 ADVENTURE/R	13' - 16'	20564	(*)	

A Blue
 N Black
 O Gold
 T Orange

 R Red
 V Green
 P Silver

(*) Check price with your distributor.
 IMPORTANT: Indicate code color after part#. Example 0973A.

OFF-ROAD FOOTPEGS

HI-TECH PARTS

2022		For the new 2022 motorcycle models check www.puig.tv		
MODEL	YEAR	REF.	A N O T R V P	
1290 SUPER ADVENTURE	15' - 16'	20564		(*)
1290 SUPER ADVENTURE T	17'	20564		(*)
1290 SUPER ADVENTURE R	17' - 20'	20564		(*)
1290 SUPER ADVENTURE S	17' - 20'	20564		(*)
SUZUKI				
RMZ 250	10' - 20'	20534		(*)
RMZ 450	10' - 20'	20534		(*)
YAMAHA				
YZ125	99' - 21'	20559		(*)
YZ250	99' - 21'	20559		(*)
YZ250F	01' - 21'	20559		(*)
YZ450F	01' - 21'	20559		(*)
YZ250X	16' - 21'	20559		(*)
YZ450FX	16' - 21'	20559		(*)
YZ250FX	15' - 20'	20559		(*)
WR250F	01' - 21'	20559		(*)
WR450F	01' - 21'	20559		(*)
WR250R	07' - 20'	20559		(*)
WR250X	07' - 20'	20559		(*)
WR450R	07' - 20'	20559		(*)
WR450X	07' - 20'	20559		(*)



SHOE PROTECTOR

HI-TECH PARTS | TECHNICAL SECTION

MODEL	REF.	N
PROTECTIVE SHIFT LEVER SLEEVE	5248N	(*)

REF. 5248N



- A Blue
- N Black
- O Gold
- T Orange
- R Red
- V Green
- P Silver

(*) Check price with your distributor.
IMPORTANT: Indicate code color after part#. Example 0973A.

- N Black

(*) Check price with your distributor.
IMPORTANT: Indicate code color after part#. Example 0973A.



TRACK OIL PLUGS

HI-TECH PARTS | TECHNICAL SECTION



* Check availability for motorcycle models at www.puig.tv typing in the searching window.



FIXATION

Secure with allen wrench to prevent theft.

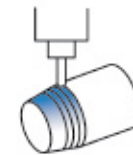

MATERIAL

Manufactured from billet aluminium.



WEIGHT

60 grams

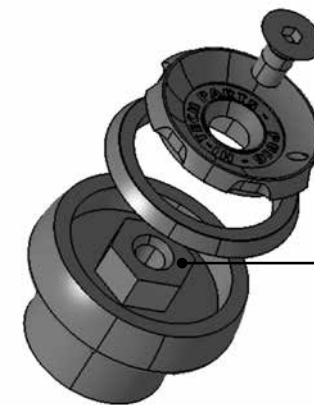

TIGHTEN AND LOOSEN WITH 10 mm. SOCKET WRENCH.



REF. 20342V



REF. 20340R



A Blue



N Black



O Gold



T Orange



R Red



V Green



P Silver



PLUG-OIL CAPS

HI-TECH PARTS | TECHNICAL SECTION



* Check availability for motorcycle models at www.puig.tv typing in the searching window.



FIXATION
Secure with allen wrench to prevent theft.

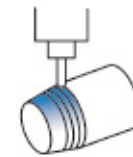

MATERIAL
Manufactured from billet aluminium.



SAFETY
Security system for track.
Wire is not supplied.



WEIGHT
60 grams

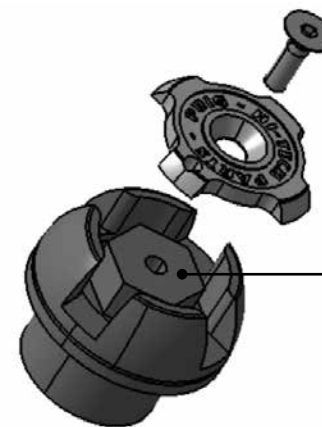

TIGHTEN AND LOOSEN WITH 10 mm. SOCKET WRENCH.



REF. 6156A



A Blue



N Black



O Gold



T Orange



R Red



V Green



P Silver



SPOOLS

HI-TECH PARTS | TECHNICAL SECTION



* Check availability for motorcycle models at www.puig.tv typing in the searching window.

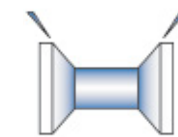

FIXATION
Fitting guide for stand support to lift up motorcycles quick and easy.

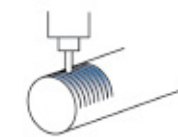

MATERIAL
Manufactured through billet aluminium and CNC machined to increase robustness.

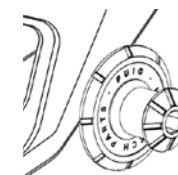

PROTECTION
The swing arm gets protected with the nylon washer added.

DESIGN
Spool and thread machined together to ease the assembly into the bike.



WEIGHT
SPOOL SLIDER
22 grams



WEIGHT
SPOOL
32 grams



WEIGHT
SPOOL PRO
40 grams

SPOOL PRO



REF. 9259R

SPOOL SLIDER



REF. 4033N

SPOOL



REF. 5924O

SPOOL / SPOOL PRO

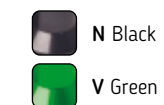
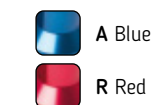

SPOOL SLIDER

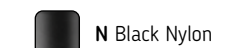



KICKSTAND EXTENSION

HI-TECH PARTS | TECHNICAL SECTION



DESIGN
Kickstand larger base extension.



DIMENSIONS

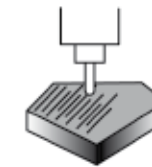

CNC MACHINED
Machined from billet aluminium and anodized in different colors.



WEIGHT
90 grams



REF. 20219N

■ N Black

FOR SPECIFIC MODELS SEE PAGE 506.

KICKSTAND EXTENSION

HI-TECH PARTS

2022	For the new 2022 motorcycle models check www.puig.tv			
MODEL	YEAR	REF.	N	
BMW				
F800GS	13' - 17'	20187N	(*)	
F700GS	12' - 17'	20188N	(*)	
F700GS	12' - 17'	20553N (&)	(*)	
F750GS	18' - 21'	20194N	(*)	
F800GS ADVENTURE	13' - 18'	20187N	(*)	
F800GT	16' - 20'	20191N	(*)	
F800R	15' - 20'	20191N	(*)	
F850GS	18' - 21'	20194N	(*)	
F900R	20' - 21'	20418N	(*)	
F900XR	20' - 21'	20418N	(*)	
G310GS	17' - 20'	20193N	(*)	
R1200GS	04' - 12'	20186N	(*)	
R1200GS	13' - 18'	20189N	(*)	
R1200GS ADVENTURE	08' - 18'	20186N	(*)	
R1200GS ADVENTURE	14' - 18'	20190N (#)	(*)	
R1200GS LC RALLYE	16' - 18'	20189N	(*)	
R1250GS	18' - 21'	20189N	(*)	
R1250GS	18' - 21'	20190N (#)	(*)	
R1250GS	18' - 21'	20519N (&)	(*)	
R1250GS ADVENTURE	18' - 20'	20190N (#)	(*)	
R1250GS ADVENTURE	18' - 20'	20519N (&)	(*)	
R1250GS HP	18' - 21'	20189N	(*)	
R1250GS HP	18' - 21'	20190N (#)	(*)	
R1250GS HP	18' - 21'	20519N (&)	(*)	
R1250GS RALLYE	18' - 21'	20189N	(*)	
R1250GS RALLYE	18' - 21'	20190N (#)	(*)	
R1250GS RALLYE	18' - 21'	20519N (&)	(*)	
S1000XR	15' - 20'	20192N	(*)	
DUCATI				
HYPERSTRADA 939	16' - 17'	20208N	(*)	
HYPERMOTARD 939/SP	16' - 20'	20208N	(*)	
HYPERMOTARD 950/SP	19' - 21'	20208N	(*)	
HYPERMOTARD 950 RVE	21'	20208N	(*)	
MULTISTRADA 1200/S	15' - 17'	20208N	(*)	
MULTISTRADA 1200 ENDURO	16'-20'	20208N	(*)	

2022	For the new 2022 motorcycle models check www.puig.tv			
MODEL	YEAR	REF.	N	
MULTISTRADA 1260 ENDURO	18' - 21'	20208N	(*)	
MULTISTRADA 1260/S/S DJAIR	18' - 20'	20208N	(*)	
MULTISTRADA 1260 PIKES PEAK	18' - 20'	20208N	(*)	
MULTISTRADA V4	21'	20276N	(*)	
MULTISTRADA V4/S/S SPORT	21'	20276N	(*)	
SCRAMBLER SIXTY2	16' - 21'	20207N	(*)	
SCRAMBLER CLASSIC	15' - 17'	20207N	(*)	
SCRAMBLER FULL THROTTLE	15' - 17'	20207N	(*)	
SCRAMBLER FULL THROTTLE	18' - 21'	20208N	(*)	
SCRAMBLER FLAT TRACK PRO	16'	20207N	(*)	
SCRAMBLER ICON	15' - 17'	20207N	(*)	
SCRAMBLER ICON	18' - 21'	20208N	(*)	
SCRAMBLER URBAN ENDURO	15' - 16'	20207N	(*)	
SCRAMBLER DESERT SLED	17' - 20'	20208N	(*)	
SCRAMBLER CAFE RACER	17' - 18'	20207N	(*)	
SCRAMBLER CAFE RACER	19' - 21'	20208N	(*)	
SCRAMBLER 1100	18' - 20'	20208N	(*)	
SCRAMBLER 1100 SPORT	18' - 20'	20208N	(*)	
SCRAMBLER 1100 SPECIAL	18' - 20'	20208N	(*)	
SUPERSPORT 939/S	17' - 20'	20208N	(*)	
HONDA				
CB125R NEO SPORTS CAFE	18' - 21'	20172N	(*)	
CB300R NEO SPORTS CAFE	18' - 21'	20172N	(*)	
CB500X	16' - 21'	20172N	(*)	
CB650R NEO SPORTS CAFE	19' - 21'	20172N	(*)	
CBR650R	19' - 21'	20172N	(*)	
CRF1000L AFRICA TWIN	16' - 19'	20173N	(*)	
CRF1000L AFRICA TWIN ADVENTURE SPORTS	18' - 19'	20173N	(*)	
CRF1100L AFRICA TWIN	20'	20281N	(*)	
CROSSRUNNER	15' - 21'	20172N	(*)	
NC750X	21'	20583N	(*)	
X-ADV	21'	20583N	(*)	
KAWASAKI				
NINJA 125	19' - 21'	20195N	(*)	
NINJA 400	18' - 21'	20196N	(*)	
NINJA 650	17' - 21'	20199N	(*)	

2022	For the new 2022 motorcycle models check www.puig.tv			
MODEL	YEAR	REF.	N	
NINJA 1000 SX	20'	20198N	(*)	
VERSYS-X 300	17' - 20'	20200N	(*)	
VERSYS 650	15' - 21'	20196N	(*)	
VERSYS 1000	15' - 20'	20197N	(*)	
Z125	17' - 21'	20195N	(*)	
Z650	17' - 21'	20198N	(*)	
Z900	17' - 21'	20198N	(*)	
KTM				
125 DUKE	11' - 21'	20174N	(*)	
200 DUKE	12' - 15'	20174N	(*)	
390 DUKE	13' - 21'	20174N	(*)	
790 DUKE	18' - 21'	20177N	(*)	
790 ADVENTURE /R	19' - 21'	20176N	(*)	
1050 ADVENTURE	15' - 16'	20176N	(*)	
1090 ADVENTURE / R	17' - 19'	20176N	(*)	
1190 ADVENTURE / R	13' - 16'	20176N	(*)	
1290 SUPER ADVENTURE	15' - 16'	20176N	(*)	
1290 SUPER ADVENTURE S	17' - 19'	20176N	(*)	
1290 SUPER ADVENTURE R	17' - 19'	20176N	(*)	
1290 SUPER ADVENTURE R/S	21'	20805N	(*)	
1290 SUPER ADVENTURE T	17' - 19'	20176N	(*)	
1290 SUPERDUKE GT	16' - 17'	20178N	(*)	
SUZUKI				
DL650 V-STROM	04' - 21'	20179N	(*)	
DL650XT V-STROM	15' - 21'	20179N	(*)	
DL1000 V-STROM	14' - 20'	20180N	(*)	
DL1000XT V-STROM	17' - 20'	20180N	(*)	
DL1050 V-STROM	20' - 21'	20408N	(*)	
DL1050XT V-STROM	20' - 21'	20408N	(*)	
GSX-S950	22'	20408N	(*)	
GSX-S1000	15' - 19'	20180N	(*)	
GSX-S1000	22'	20408N	(*)	
GSX-S1000F	15' - 19'	20180N	(*)	
TRIUMPH				
TRIDENT 660	21'	20633N	(*)	
TIGER 900	20' - 21'	20459N	(*)	

2022	For the new 2022 motorcycle models check www.puig.tv			
MODEL	YEAR	REF.	N	
TIGER 900 GT	20' - 21'	20459N	(*)	
TIGER 900 GT LOW	20' - 21'	20567N	(*)	
TIGER 900 GT PRO	20' - 21'	20459N	(*)	
TIGER 900 RALLY	20' - 21'	20568N	(*)	
TIGER 900 RALLY PRO	20' - 21'	20568N	(*)	
TIGER SPORT	13' - 20'	20203N	(*)	
TIGER EXPLORER	12' - 15'	20202N	(*)	
TIGER EXPLORER XC	13' - 15'	20202N	(*)	
TIGER EXPLORER XR / XRX / XRT	16' - 17'	20205N	(*)	
TIGER EXPLORER XR / XRT / XRX	18' - 20'	20770N	(*)	
TIGER EXPLORER XC/XCX / XCA	16' - 17'	20205N	(*)	
TIGER EXPLORER XC/XCX / XCA	18' - 20'	20770N	(*)	
TIGER 1200 ALPINE / DESERT	21'	20770N	(*)	
YAMAHA				
NIKEN	18' - 21'	20185N	(*)	
MT-03	16' - 21'	20185N	(*)	
MT-07	14' - 21'	20183N	(*)	
MT-07 TRACER	16' - 21'	20183N	(*)	
MT-09	13' - 20'	20182N	(*)	
MT-09	21'	20677N	(*)	
MT-09 SP	17' - 20'	20182N	(*)	
MT-09 SP	21'	20677N	(*)	
MT-09 TRACER	15' - 20'	20184N	(*)	
MT-09 TRACER	21'	20677N	(*)	
MT-09 TRACER GT	18' - 20'	20184N	(*)	
MT-09 TRACER GT	21'	20677N	(*)	
MT-10	16' - 21'	20181N	(*)	
TENERE 700	19' - 21'	20298N	(*)	
TENERE 700 RALLY EDITION	19' - 21'	20298N	(*)	
XSR 700	16' - 20'	20183N	(*)	
XSR 900	16' - 20'	20184N	(*)	
XT1200Z SUPER TENERE	14' - 21'	20762N	(*)	
YZF-R1	15' - 20'	20181N	(*)	

(#) Model with Sport suspension.
(&) Model with lowered suspension.
(*) Check price with your distributor.

IMPORTANT: Indicate code color after part#. Example 0973A.

(#) Modelo con suspensión Sport.
(&) Modelo con suspensión Rebajada.
(*) Check price with your distributor.

IMPORTANT: Indicate code color after part#. Example 0973A.

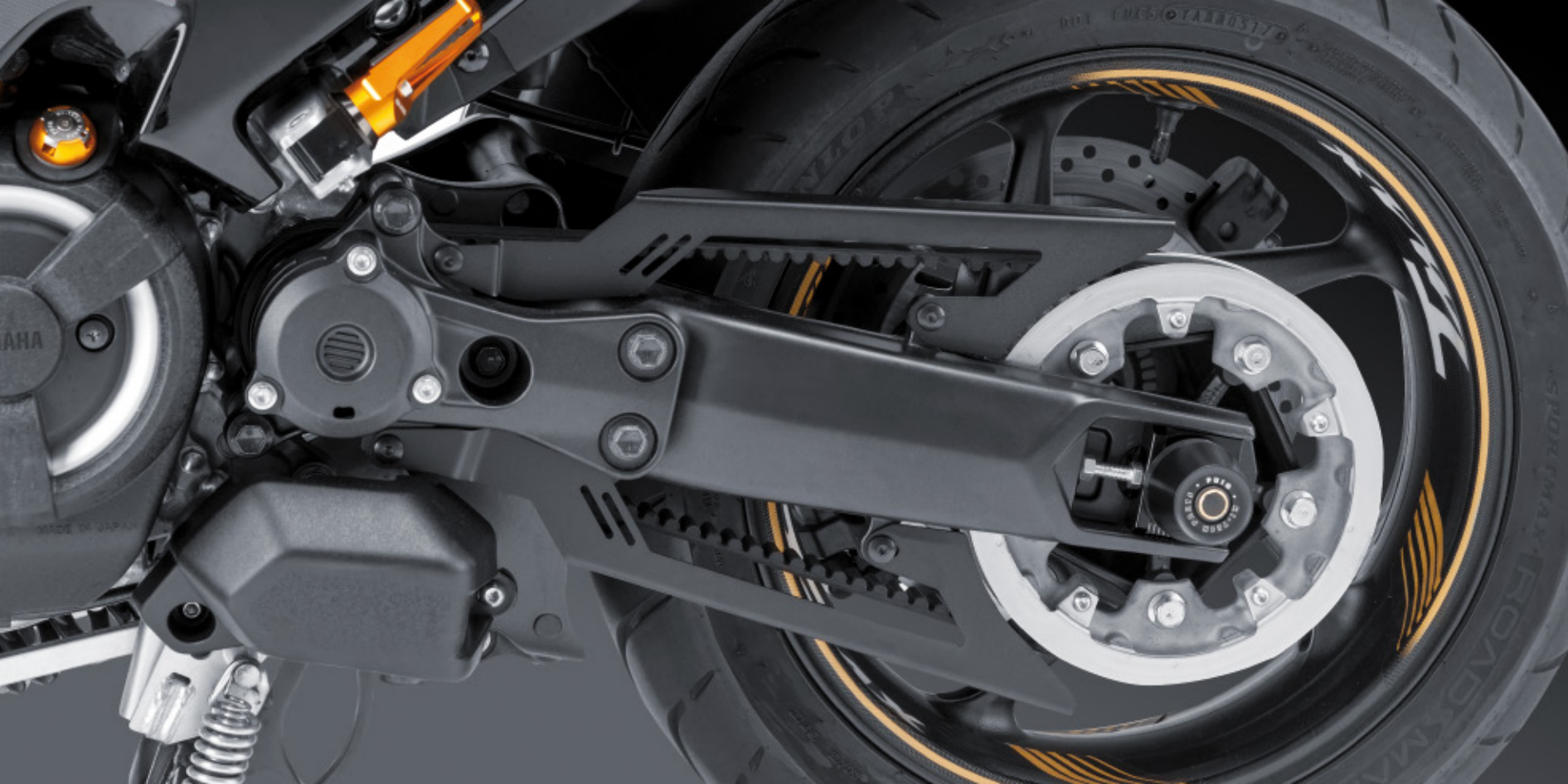

SHAFT COVER

HI-TECH PARTS | TECHNICAL SECTION

MODEL	YEAR	REF.	N
KYMCO			
AK550	17' - 21'	9543	(*)
YAMAHA			
T-MAX 530	12' - 16'	6336	(*)
T-MAX 530/DX/SX	17' - 19'	9455	(*)
T-MAX 560 /SX/DX/MAX TECH	20' - 21'	9455	(*)

 N Black



REF. 6336N

(*) Check price with your distributor.
IMPORTANT: Indicate code color after part#. Example 0973A.

CROWN COIL

HI-TECH PARTS | TECHNICAL SECTION

MODEL	YEAR	REF.	A	N	O	R	P
KYMCO							
AK550	17' - 21'	9546				(*)	
YAMAHA							
T-MAX 530	12' - 16'	7359				(*)	
T-MAX/DX/SX	17' - 19'	9854				(*)	
T-MAX 560 /SX/DX/MAX TECH	20' - 21'	9854				(*)	

 A Blue

 N Black

 R Red

 O Gold

 P Silver



REF. 7359R

(*) Check price with your distributor.
IMPORTANT: Indicate code color after part#. Example 0973A.

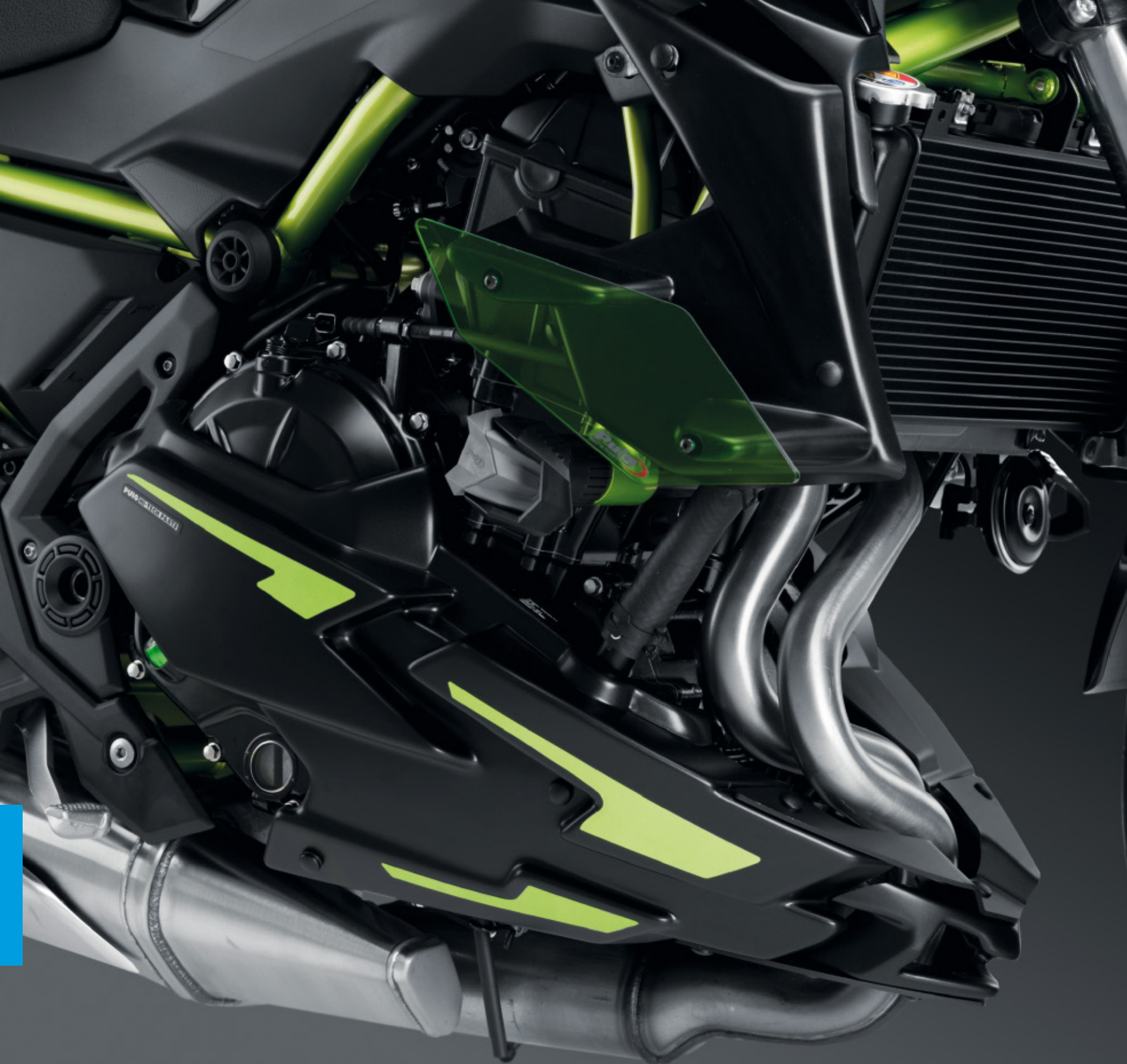

ENGINE SPOILERS

HI-TECH PARTS | TECHNICAL SECTION



EACH BIKE MODEL HAS ITS OWN DESIGN AND STYLE, TESTED IN OUR VIRTUAL WIND TUNNEL.

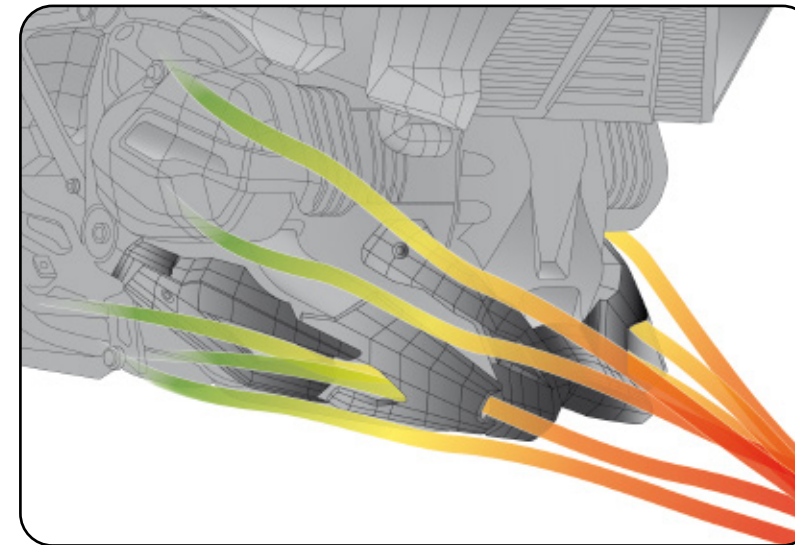

Improve stability and look.

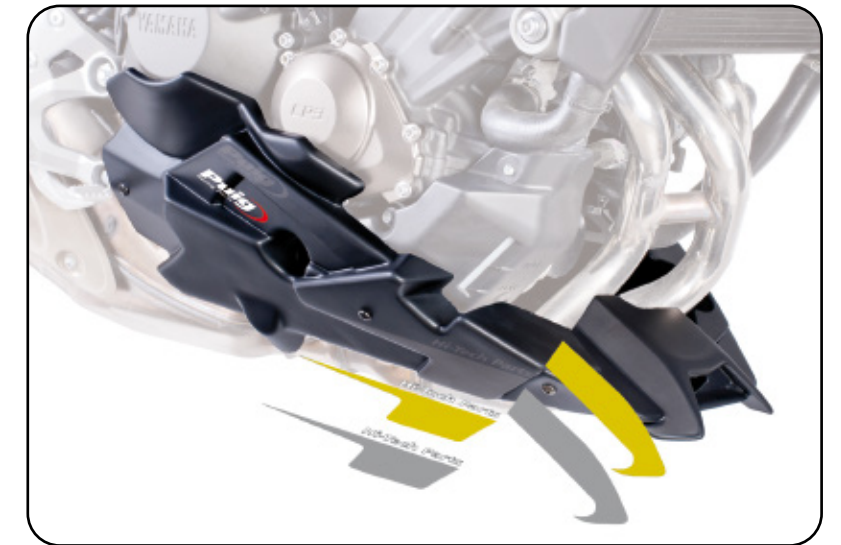

Adhesives to personalize at own taste according to bike models.

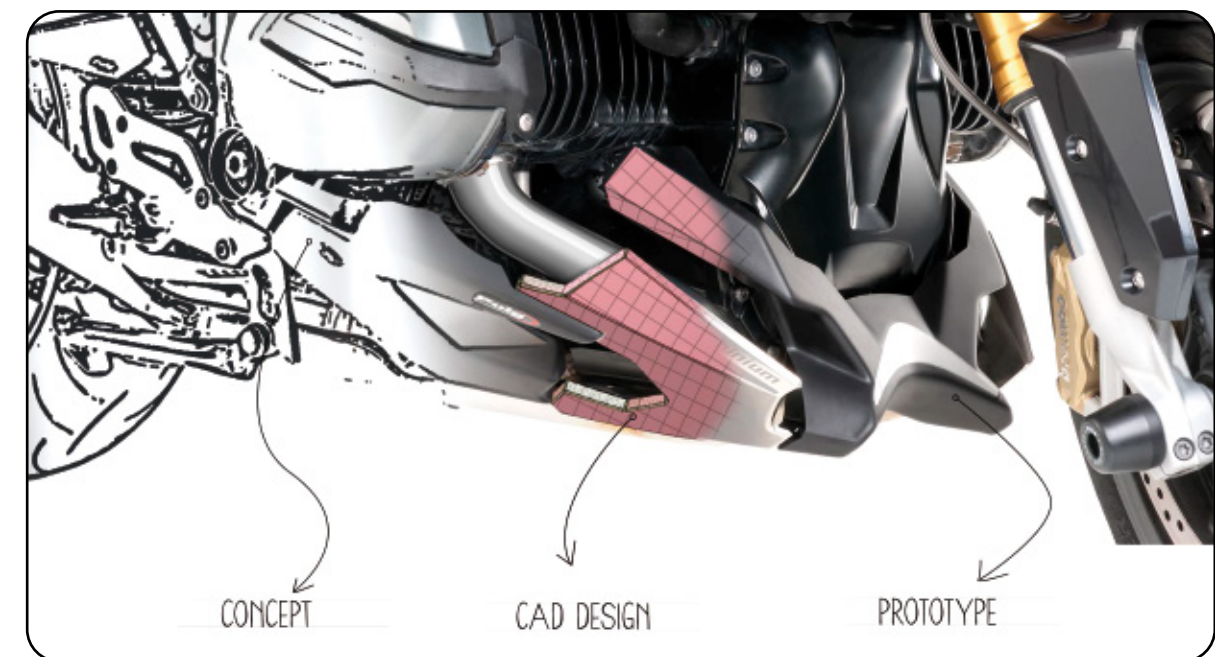

Multiple steps to a unic development.

ENGINE SPOILERS



HI-TECH PARTS

2022		For the new 2022 motorcycle models check www.puig.tv				
MODEL	YEAR	ADHESIVE KIT	REFERENCE	J	C	
BMW						
R1200 S	06' - 08'	NOT INCLUDED	4420N	(*)		
R1200 R	15' - 18'	INCLUDED	7690	(*)	(*)	
R1200 RS	15' - 18'	INCLUDED	7690	(*)	(*)	
DUCATI						
MONSTER 937	21'		20714	(*)	(*)	
MONSTER 937 PLUS	21'		20714	(*)	(*)	
HONDA						
CB650F	14' - 18'	INCLUDED	7021	(*)	(*)	
CB1000R	08' - 16'	INCLUDED	4696	(*)	(*)	
CBF500	04' - 07'	NOT INCLUDED	4000N	(*)	(*)	
CB650R NEO SPORTS CAFÉ	19' - 21'	INCLUDED	7021	(*)	(*)	
CB1000R NEO SPORTS CAFE	18' - 21'	INCLUDED	9746	(*)	(*)	
CB1000R BLACK EDITION	21'	INCLUDED	9746	(*)	(*)	
KAWASAKI						
Z400	19' - 21'	NOT INCLUDED	3554	(*)	(*)	
Z650	17' - 19'	INCLUDED	9589	(*)		
Z650	20' - 21'	INCLUDED	20295	(*)	(*)	
Z750	07' - 12'	INCLUDED	4525	(*)	(*)	
Z750R	11' - 12'	INCLUDED	4525	(*)	(*)	
Z800	13' - 16'	INCLUDED	6507	(*)	(*)	
Z800E	13' - 16'	INCLUDED	6507	(*)	(*)	
Z900	17' - 21'	INCLUDED	9703	(*)	(*)	
Z1000	07' - 09'	INCLUDED	4525	(*)	(*)	
KTM						
790 DUKE	18' - 21'	INCLUDED	9669	(*)	(*)	
890 DUKE R	20' - 21'	INCLUDED	9669	(*)	(*)	
1290 SUPERDUKE R	14' - 19'	INCLUDED	7573	(*)	(*)	
1290 SUPERDUKE R FOR AKRAPOVIC EXHAUST	14' - 19'	INCLUDED	7573	(*)	(*)	
1290 SUPERDUKE R	20' - 21'	INCLUDED	20428	(*)	(*)	
1290 SUPERDUKE GT	16' - 21'	INCLUDED	7573	(*)	(*)	
SUZUKI						
DL650 V-STROM	04' - 11'	INCLUDED	8559	(*)	(*)	
DL650 V-STROM	12' - 21'	INCLUDED	5896		(*)	
DL650XT V-STROM	15' - 21'	INCLUDED	5896		(*)	
DL1000 V-STROM	14' - 16'	INCLUDED	7231		(*)	
GSF650 BANDIT	07' - 11'	INCLUDED	4415	(*)	(*)	
GSF650S BANDIT	07' - 14'	INCLUDED	4415	(*)	(*)	
GSF1250 BANDIT	07' - 13'	INCLUDED	4415	(*)	(*)	
GSF1250S BANDIT	07' - 16'	INCLUDED	4415	(*)	(*)	
GSR750	07' - 16'	INCLUDED	5682	(*)	(*)	

2022

For the new 2022 motorcycle models check www.puig.tv

MODEL	YEAR	ADHESIVE KIT	REFERENCE	J	C
SV650	99' - 02'	INCLUDED	8559	(*)	(*)
SV650	16' - 21'	INCLUDED	8559	(*)	(*)
SV650/S	03' - 08'	INCLUDED	8559	(*)	(*)
SV650X	18' - 21'	INCLUDED	8559	(*)	(*)
YAMAHA					
FZ1/FAZER	06' - 15'	NOT INCLUDED	4135	(*)	(*)
MT-07 - WITH ORIGINAL EXHAUST	14' - 20'	INCLUDED	7022	(*)	(*)
MT-07 - WITH AKRAPOVIC EXHAUST	14' - 20'	INCLUDED	7022	(*)	(*)
MT-07	21'	NOT INCLUDED	20624	(*)	(*)
MT-07 TRACER -WITH ORIGINAL EXHAUST	16' - 19'	INCLUDED	7022	(*)	(*)
MT-07 TRACER - WITH AKRAPOVIC EXHAUST	16' - 19'	INCLUDED	7022	(*)	(*)
MT-07 TRACER GT - WITH ORIGINAL EXHAUST	19'	INCLUDED	7022	(*)	(*)
MT-07 TRACER GT - WITH AKRAPOVIC EXHAUST	19'	INCLUDED	7022	(*)	(*)
MT-09 - WITH ORIGINAL EXHAUST	13' - 20'	INCLUDED	7692	(*)	(*)
MT-09 - WITH AKRAPOVIC EXHAUST	13' - 20'	INCLUDED	7540	(*)	(*)
MT-09 SP - WITH ORIGINAL EXHAUST	18' - 20'	INCLUDED	7692	(*)	(*)
MT-09 SP - WITH AKRAPOVIC EXHAUST	18' - 20'	INCLUDED	7540	(*)	(*)
MT-09 TRACER - WITH ORIGINAL EXHAUST	15' - 20'	INCLUDED	7692	(*)	(*)
MT-09 TRACER - WITH AKRAPOVIC EXHAUST	15' - 20'	INCLUDED	7540	(*)	(*)
MT-09 TRACER GT - WITH ORIGINAL EXHAUST	18' - 20'	INCLUDED	7692	(*)	(*)
MT-09 TRACER GT - WITH AKRAPOVIC EXHAUST	18' - 20'	INCLUDED	7540	(*)	(*)
MT-09	21'	NOT INCLUDED	20646	(*)	(*)
MT-09 SP	21'	NOT INCLUDED	20646	(*)	(*)
MT-09 TRACER	21'	NOT INCLUDED	20646	(*)	(*)
MT-09 TRACER GT	21'	NOT INCLUDED	20646	(*)	(*)

-  J Matt black
-  C Carbon look

ATTENTION: PREVIOUSLY VERIFY ANY INTERFERENCE BETWEEN OUR PRODUCT AND ANY OTHER ACCESSORY (OEM OR AFTERMARKET) ALREADY INSTALLED ON THE MOTORCYCLE.

(*) Check price with your distributor.
IMPORTANT: Indicate code color after part#. Example 0973A.



CHASSIS CAP COVERS

HI-TECH PARTS | TECHNICAL SECTION



2 FUNCTIONALITIES

Cover hollow areas of the chassis and improves look of the bike.



2022		For the new 2022 motorcycle models check www.puig.tv		
MODEL	YEAR	REF.	N	
BENELLI				
LEONCINO 500	15' - 21'	3520	(*)	
LEONCINO TRAIL	15' - 21'	3520	(*)	
BMW				
F750GS	18' - 21'	0096	(*)	
F850GS	18' - 21'	0096	(*)	
R1200GS EXCLUSIVE	17' - 21'	9332	(*)	
R1200GS RALLYE	17' - 21'	9332	(*)	
R1200GS ADVENTURE	13' - 18'	9332	(*)	
R1200GS ADVENTURE	13' - 18'	3521	(*)	
R1200R	15' - 18'	9333	(*)	
R1200RS	15' - 18'	9333	(*)	
R1200RT	14' - 18'	0327	(*)	
R1200GS	13' - 18'	3521	(*)	
R1200GS	13' - 18'	9332	(*)	
R1250GS	19' - 21'	9332	(*)	
R1250GS ADVENTURE	19' - 21'	9332	(*)	
R1250RT	19' - 20'	0327	(*)	
R1250R	19' - 21'	9333	(*)	
R1250RS	19' - 21'	9333	(*)	
R NINE T	17' - 21'	9664	(*)	
R NINE T PURE	17' - 21'	9664	(*)	
R NINE T RACER	17' - 21'	9664	(*)	
R NINE T URBAN G/S	17' - 21'	9664	(*)	
R NINE T SCRAMBLER	17' - 21'	9664	(*)	
DUCATI				
DIAVEL	11' - 21'	9611	(*)	
899 PANIGALE	13' - 15'	9631	(*)	

N Black

2022		For the new 2022 motorcycle models check www.puig.tv		
MODEL	YEAR	REF.	N	
959 PANIGALE	16' - 21'	9631	(*)	
MONSTER 797	17' - 21'	9632	(*)	
MONSTER 821	14' - 16'	9633	(*)	
MONSTER 1200/S	14' - 16'	9633	(*)	
HYPERMOTARD 939	16' - 21'	9634	(*)	
HYPERSTRADA 939/SP	16' - 21'	9634	(*)	
MULTISTRADA 1200/ S	10' - 14'	9635	(*)	
MULTISTRADA 1200/S	15' - 21'	9636	(*)	
MULTISTRADA 1200 PIKES PEAK	15' - 21'	9636	(*)	
MULTISTRADA 1200 ENDURO/PRO	15' - 21'	9636	(*)	
SCRAMBLER ICON/CLASSIC/FULL THROTTLE	15' - 21'	9632	(*)	
SCRAMBLER SIXTY2	15' - 21'	9632	(*)	
SCRAMBLER URBAN ENDURO	15' - 21'	9632	(*)	
SCRAMBLER FLAT TRACK PRO	15' - 21'	9632	(*)	
SCRAMBLER DESERT SLED	15' - 21'	9632	(*)	
SCRAMBLER CAFE RACER	15' - 21'	9632	(*)	
SCRAMBLER 1100	18' - 21'	3522	(*)	
X DIAVEL/S	16' - 21'	9705	(*)	
HONDA				
CB125R NEO SPORTS CAFE	18' - 21'	9801	(*)	
CB300R NEO SPORTS CAFE	18' - 21'	9801	(*)	
CB1000R NEO SPORTS CAFE	18' - 21'	9809	(*)	
CB1000R BLACK EDITION	21'	9809	(*)	
MONKEY 125	18' - 21'	3523	(*)	
KAWASAKI				
NINJA 400	18' - 21'	9796	(*)	
NINJA 650	17' - 21'	9637	(*)	
VERSYS 1000	12' - 21'	3509	(*)	
Z650	17' - 19'	9637	(*)	
Z900	17' - 21'	9777	(*)	
Z900RS	18' - 21'	9778	(*)	
KTM				
1290 SUPERDUKE R	14' - 19'	9787	(*)	
1290 SUPERDUKE GT	16' - 21'	9787	(*)	
SUZUKI				
DL250 V-STROM	18' - 21'	3524	(*)	
DL650 V-STROM	12' - 21'	3893	(*)	
YAMAHA				
MT-07	13' - 21'	9638	(*)	
MT-07 TRACER	16' - 21'	9638	(*)	
MT-07 TRACER GT	20' - 21'	9638	(*)	
TENERE 700	19' - 21'	3713	(*)	
XSR700	15' - 21'	9638	(*)	

(*) Check price with your distributor.

IMPORTANT: Indicate code color after part#. Example 0973A.

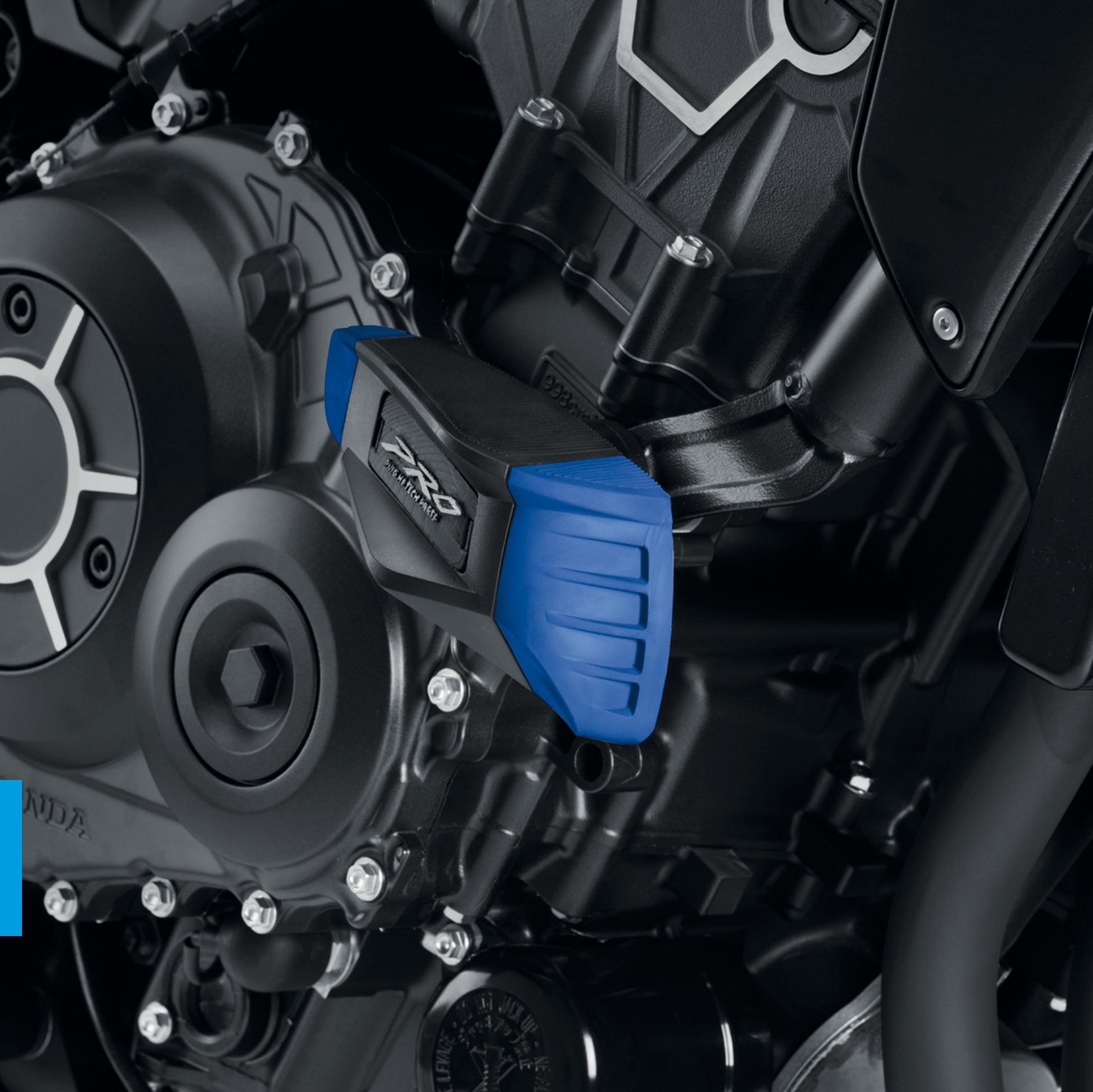

FRAME SLIDERS PRO 2.0

HI-TECH PARTS | TECHNICAL SECTION

Puig
Bodyworks

NEW!

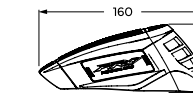

DIMENSIONS
160 X 64 mm.



PROTECTION
Front and rear protection with flexible zones.



DESIGN
Sliders do not stand out from handlebar and touch after the footpegs.

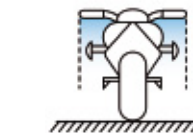

COMPLETE PROTECTION
Protect engine and chassis.

RUBBER END

Available in different colors.



N Black



SPARES	REF.	A	P	R	V	N
SET OF RUBBER SECTIONS REAR/FRONT & RIGHT/LEFT (4 PARTS) C/BLUE	20872					(*)
SET OF RUBBER SECTIONS REAR/FRONT & RIGHT/LEFT (4 PARTS) C/GREY	20872					(*)
SET OF RUBBER SECTIONS REAR/FRONT & RIGHT/LEFT (4 PARTS) C/RED	20872					(*)
SET OF RUBBER SECTIONS REAR/FRONT & RIGHT/LEFT (4 PARTS) C/GREEN	20872					(*)
LID SET WITH LOGO C/BLACK	20873					(*)
NYLON PUCKS BY PAIR FOR SCREW M10	20874					(*)
NYLON PUCKS BY PAIR FOR SCREW M12	20875					(*)

FOR SPECIFIC MODELS SEE PAGE 526.

(*) Check price with your distributor.
IMPORTANT: Indicate code color after part#. Example 0973A.



FRAME SLIDERS PRO

HI-TECH PARTS | TECHNICAL SECTION



BODY

Nylon pucks in black colour.



Avoid knee injuries.



DESIGN

Sliders do not stand out from handlebar and touch after the footpegs.

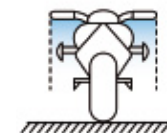

COMPLETE PROTECTION

Protect engine and chassis.

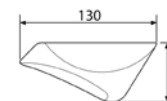

DIMENSIONS

RUBBER END

Available in different colors.



N Black

REF. 6068N + 5533R



SPARES	REF.	A	P	R	V	N
RUBBER END BY PAIR C/BLUE	5533				(*)	
RUBBER END BY PAIR C/GREY	5533				(*)	
RUBBER END BY PAIR C/RED	5533				(*)	
RUBBER END BY PAIR C/GREEN	5533				(*)	
LID SET WITH LOGO C/BLACK	5534					(*)
NYLON PUCKS BY PAIR FOR SCREW M10	5536					(*)
NYLON PUCKS BY PAIR FOR SCREW M12	20354					(*)

FOR SPECIFIC MODELS SEE PAGE 526.

(*) Check price with your distributor.
 IMPORTANT: Indicate code color after part#. Example 0973A.

FRAME SLIDERS R19

HI-TECH PARTS | TECHNICAL SECTION

BODY

Nylon pucks in black colour.



RUBBER

Protects rider's knee from possible hits while getting on the bike.
Supplied in grey color.

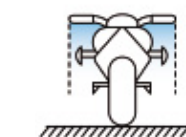

DESIGN

Sliders do not stand out from handlebar and touch after the footpegs.



COMPLETE PROTECTION

Protect engine and chassis.

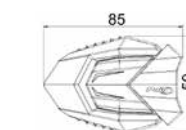

DIMENSIONS

RUBBER ENDS AVAILABLE IN VARIOUS COLORS

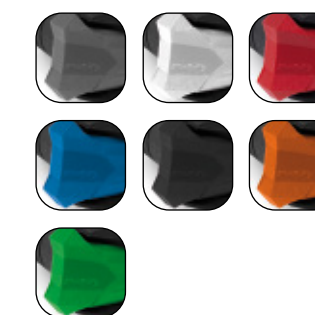

N Black



REF. 9355N

SPARE RUBBERS		REF.	A	B	N	T	R	U	V
RUBBER END PROTECTOR R19 BY PAIR		3148							

SPARES PUCKS		REF.	N
NYLON PUCKS + RUBBER END C/GREY BY PAIR MOD. R19 DE 85 mm. FOR SCREW M10	3149	(*)	
NYLON PUCKS + RUBBER END C/GREY BY PAIR MOD. R19 DE 85 mm. FOR SCREW M12	3150	(*)	
NYLON PUCKS + RUBBER END C/GREY BY PAIR MOD. R19 DE 50 mm. FOR SCREW M10	3151	(*)	
NYLON PUCKS + RUBBER END C/GREY BY PAIR MOD. R19 DE 50 mm. FOR SCREW M12	3152	(*)	

SPARES		REF.	A	B	R	U	V	N
NYLON PUCK VINTAGE 2.0 FOR M10 BOLT (COMPATIBLE WITH R19 PUCKS)	3153	(*)						
NYLON PUCK VINTAGE 2.0 FOR M12 BOLT (COMPATIBLE WITH R19 PUCKS)	3154	(*)						
RUBBER END PROTECTOR VINTAGE 2.0. BY PAIR	3667	(*)						

FOR SPECIFIC MODELS SEE PAGE 526.

(*) Check price with your distributor.
IMPORTANT: Indicate code color after part#. Example 0973A.

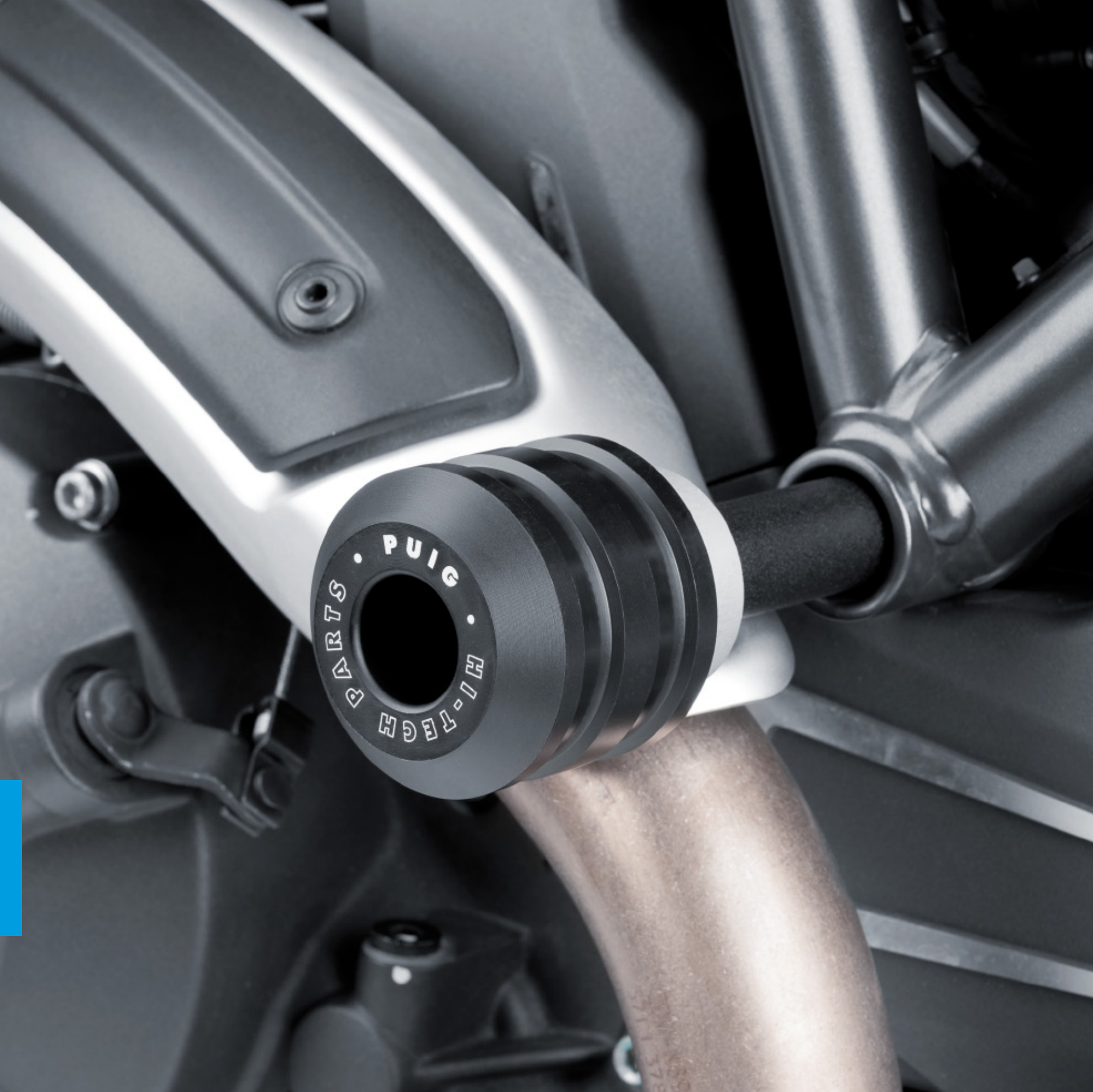

FRAME SLIDERS VINTAGE

HI-TECH PARTS | TECHNICAL SECTION



REF. 8150N

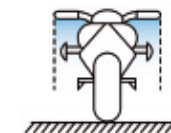

DESIGN

Sliders do not stand out from handlebar and touch after the footpegs.



COMPLETE PROTECTION

Protect engine and chassis.

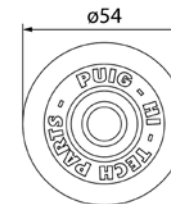

DIMENSIONS

SPARES	REFERENCE	N
NYLON PUCK FOR M10 BOLT	9562	(*)
NYLON PUCK FOR M12 BOLT	9563	(*)

FOR SPECIFIC MODELS SEE PAGE 526.

 N Black

(*) Check price with your distributor.
IMPORTANT: Indicate code color after part#. Example 0973A.



FRAME SLIDERS VINTAGE 2.0

HI-TECH PARTS | TECHNICAL SECTION

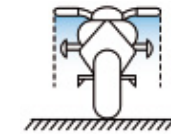

DESIGN

Sliders do not stand out from handlebar and touch after the footpegs.



COMPLETE PROTECTION

Protect engine and chassis.

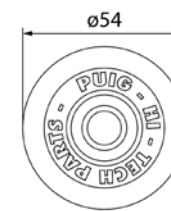

DIMENSIONS

RUBBER ENDS AVAILABLE IN VARIOUS COLORS



N Black

REF. 20390N-3667A



SPARES	REF.	A	B	R	U	V	N
NYLON PUCK FOR M10 BOLT (COMPATIBLE WITH R19 PUCKS)	3153						(*)
NYLON PUCK FOR M12 BOLT (COMPATIBLE WITH R19 PUCKS)	3154						(*)
RUBBER END PROTECTOR VINTAGE 2.0. BY PAIR	3667						(*)

FOR SPECIFIC MODELS SEE PAGE 526.

(*) Check price with your distributor.
IMPORTANT: Indicate code color after part#. Example 0973A.

FRAME SLIDERS

HI-TECH PARTS | TYPE OF FRAME SLIDERS:

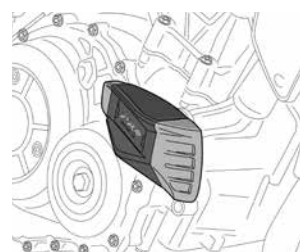

FRAME SLIDER PRO 2.0

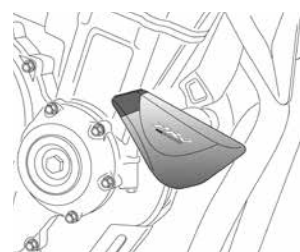

FRAME SLIDER PRO

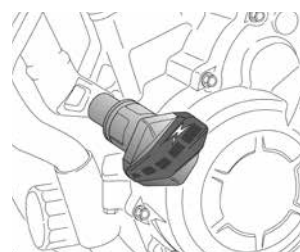

FRAME SLIDER R19



FRAME SLIDER VINTAGE

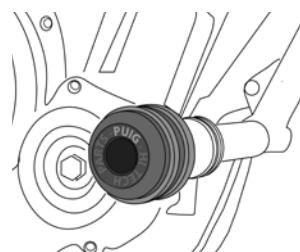

FRAME SLIDER VINTAGE 2.0

2022		For the new 2022 motorcycle models check www.puig.tv			
MODEL	YEAR	TYPE OF FRAME SLIDER	REFERENCE	N	
APRILIA					
DORSODURO 750	08' - 16'	R19	4706	(*)	
DORSODURO 900	17' - 21'	R19	4706	(*)	
DORSODURO 1200	11' - 16'	R19	4706	(*)	
RS 660	21'	R19	20606	(*)	
RSV4	09' - 12'	PRO	3158	(*)	
RSV4	09' - 12'	R12	5578	(*)	
RSV4 FACTORY	13' - 14'	PRO	3158	(*)	
RSV4 R	13' - 14'	PRO	3158	(*)	
RSV4 RF	15' - 16'	PRO	3158	(*)	
RSV4 RF	17' - 20'	PRO	3158	(*)	
RSV4 RR	15' - 16'	PRO	3158	(*)	
RSV4 RR	17' - 20'	PRO	3158	(*)	
SHIVER 750	07' - 16'	R19	4706	(*)	
SHIVER 900	17' - 21'	R19	4706	(*)	
SHIVER GT	08' - 16'	R19	4706	(*)	
TUONO V4R	11' - 14'	PRO	3158	(*)	
TUONO V4 1100 RR	15' - 16'	PRO	3158	(*)	
TUONO V4 1100 FACTORY	15' - 16'	PRO	3158	(*)	
BENELLI					
BN 125	18' - 21'	R19	7716	(*)	
BN 251	15' - 21'	R12	3511	(*)	
BN 302	14' - 20'	R19	8106	(*)	
BN 302S	19' - 21'	R19	8106	(*)	
LEONCINO 250	20' - 21'	VINTAGE 2.0	20390	(*)	
LEONCINO 500	16' - 21'	VINTAGE 2.0	20423	(*)	
BMW					
F750GS	18' - 21'	VINTAGE	9779	(*)	
F800 R	09' - 14'	R19	4185	(*)	
F800 R	15' - 20'	R19	7707	(*)	
F800 S	06' - 11'	R19	4185	(*)	

2022		For the new 2022 motorcycle models check www.puig.tv			
MODEL	YEAR	TYPE OF FRAME SLIDER	REFERENCE	N	
F850GS	18' - 21'	VINTAGE	9779	(*)	
F900 R	20' - 21'	R19	20293	(*)	
F900 R	20' - 21'	PRO	20389	(*)	
F900 XR	20' - 21'	R19	20388	(*)	
F900 XR	20' - 21'	PRO	20389	(*)	
G310 GS	17' - 21'	R19	8566	(*)	
G310 R	16' - 21'	R19	8566	(*)	
S1000 R	14' - 16'	R12	7061	(*)	
S1000 R	17' - 20'	R19	9488	(*)	
S1000 R	21'	R19	20861	(*)	
S1000RR	09' - 11'	R19	5579	(*)	
S1000RR	09' - 11'	PRO	5282	(*)	
S1000RR	12' - 14'	R12	6060	(*)	
S1000RR	12' - 14'	PRO	6070	(*)	
S1000RR	15' - 18'	R19	5579	(*)	
S1000RR	15' - 18'	PRO	5282	(*)	
S1000RR	19' - 21'	R19	3706	(*)	
S1000RR	19' - 21'	PRO	3707	(*)	
S1000 XR	15' - 19'	R19	7709	(*)	
S1000 XR	20' - 21'	PRO	20458	(*)	
S1000 XR	20' - 21'	R19	20457	(*)	
BRIXTON					
CROSSFIRE 500		VINTAGE 2.0	20549	(*)	
CROSSFIRE 500X		VINTAGE 2.0	20549	(*)	
DUCATI					
HYPERMOTARD 821/SP	13' - 15'	R12	6557	(*)	
HYPERMOTARD 939/SP	16' - 18'	R12	6557	(*)	
HYPERSTRADA 939	16' - 17'	R12	6557	(*)	
HYPERMOTARD 950/SP	19' - 21'	R19	9497	(*)	
HYPERMOTARD 950 RVE	21'	R19	9497	(*)	
MONSTER 620	02' - 06'	R12	1850	(*)	
MONSTER 695	06' - 07'	R12	1850	(*)	
MONSTER 696	08' - 14'	R12	4705	(*)	
MONSTER 796	10' - 14'	R12	4705	(*)	
MONSTER 797	17' - 20'	R19	9497	(*)	
MONSTER 800	03' - 04'	R12	1850	(*)	
MONSTER 821	14' - 20'	R19	7062	(*)	
MONSTER 937	21'	R19	20716	(*)	
MONSTER 937 PLUS	21'	R19	20716	(*)	

N Black

(-) Supplied with holesaw to drill bodywork.

(*) Check price with your distributor.

IMPORTANT: Indicate code color after part#. Example 0973A.

FRAME SLIDERS

HI-TECH PARTS | TYPE OF FRAME SLIDERS:

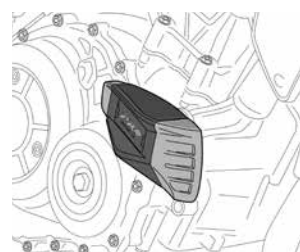

FRAME SLIDER PRO 2.0

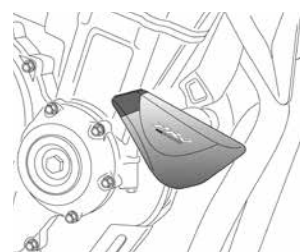

FRAME SLIDER PRO

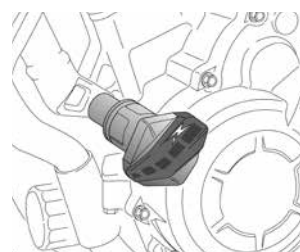

FRAME SLIDER R19



FRAME SLIDER VINTAGE

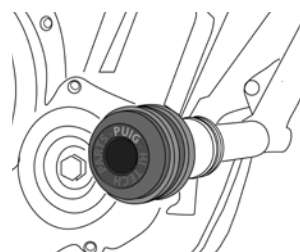

FRAME SLIDER VINTAGE 2.0

2022		For the new 2022 motorcycle models check www.puig.tv			
MODEL	YEAR	TYPE OF FRAME SLIDER	REFERENCE	N	
MONSTER 1000	02' - 05'	R12	1850	(*)	
MONSTER 1100/S	09' - 10'	R12	4705	(*)	
MONSTER 1100 EVO	11' - 13'	R12	4705	(*)	
MONSTER 1200/S	14' - 16'	R19	7062	(*)	
MONSTER 1200/S	17' - 21'	R19	7062	(*)	
MONSTER 1200 R	16' - 20'	R19	7062	(*)	
SCRAMBLER ICON	15' - 21'	VINTAGE	8150	(*)	
SCRAMBLER CLASSIC	15' - 21'	VINTAGE	8150	(*)	
SCRAMBLER URBAN ENDURO	15' - 16'	VINTAGE	8150	(*)	
SCRAMBLER FULL THROTTLE	15' - 21'	VINTAGE	8150	(*)	
SCRAMBLER SIXTY2	16' - 21'	VINTAGE	8150	(*)	
SCRAMBLER FLAT TRACK PRO	16'	VINTAGE	8150	(*)	
SCRAMBLER DESERT SLED	17' - 20'	VINTAGE	8150	(*)	
SCRAMBLER CAFE RACER	17' - 21'	VINTAGE	8150	(*)	
SCRAMBLER 1100	18' - 21'	VINTAGE	8150	(*)	
SCRAMBLER 1100 SPORT	18' - 21'	VINTAGE	8150	(*)	
SCRAMBLER 1100 SPECIAL	18' - 21'	VINTAGE	8150	(*)	
STREETFIGHTER V4/S	20' - 21'	R19	20468	(*)	
HARLEY DAVIDSON					
STREET 750 XG750	17' - 21'	VINTAGE 2.0	21042	(*)	
HONDA					
CB125F	15' - 21'	R19	7931	(*)	
CB125R NEO SPORTS CAFE	18' - 21'	R19	9654	(*)	
CB300F	15' - 19'	R12	7932	(*)	
CB300R NEO SPORTS CAFE	18' - 21'	R19	9757	(*)	
CB500F	13' - 21'	PRO	6468	(*)	
CB500F	13' - 21'	R19	6560	(*)	
CB500X	13' - 21'	PRO	6468	(*)	
CB500X	13' - 21'	R19	6560	(*)	
CB600F HORNET	98' - 06'	R19	1851	(*)	
CB600F HORNET	07' - 15'	R19	4423	(*)	

2022		For the new 2022 motorcycle models check www.puig.tv			
MODEL	YEAR	TYPE OF FRAME SLIDER	REFERENCE	N	
CB650F	14' - 16'	R19	7057	(*)	
CB650F	14' - 16'	PRO	7070	(*)	
CB650F	17' - 20'	R19	9443	(*)	
CB650F	17' - 20'	PRO	7070	(*)	
CB650R NEO SPORTS CAFE	19' - 21'	R19	9443	(*)	
CB650R NEO SPORTS CAFE	19' - 21'	PRO	7070	(*)	
CB1000R	08' - 15'	PRO	5283	(*)	
CB1000R NEO SPORTS CAFE	18' - 21'	R19	9753	(*)	
CB1000R NEO SPORTS CAFE	18' - 21'	PRO	9754	(*)	
CB1000R BLACK EDITION	21'	R19	9753	(*)	
CB1000R BLACK EDITION	21'	PRO	9754	(*)	
CBF600	04' - 07'	R19	1853	(*)	
CBF600/S	08' - 14'	R19	4423	(*)	
CBR500R	16' - 18'	PRO	8575	(*)	
CBR500R	16' - 18'	R19	8576	(*)	
CBR500R	19' - 21'	R19	3598	(*)	
CBR600F	99' - 07'	R12	1856	(*)	
CBR600RR	03' - 06'	R19 (-)	1857	(*)	
CBR600RR	07' - 08'	R19	4424	(*)	
CBR650F	14' - 16'	R19	7056	(*)	
CBR650F	17' - 19'	R19	7056	(*)	
CBR650F	08' - 16'	PRO	5283	(*)	
CBR650R	19' - 21'	R19	20792	(*)	
CBR1000RR FIREBLADE/SP	20' - 21'	R19	20490	(*)	
CBR1000RR FIREBLADE/SP	20' - 21'	PRO	20491	(*)	
CMX 500 REBEL	17' - 21'	VINTAGE 2.0	21045	(*)	
CMX 1100 REBEL	21'	VINTAGE 2.0	21046	(*)	
CROSSRUNNER	11' - 14'	R12	5695	(*)	
NC700S/X	12' - 13'	PRO	6063	(*)	
NC700S/X	12' - 13'	R19	6047	(*)	
NC750S/X	14' - 21'	R19	6047	(*)	
NC750S/X	14' - 21'	PRO	6063	(*)	
VTR1000F FIRE STORM	97' - 07'	R12	3909	(*)	
HUSQVARNA					
SVARTPILEN 125	21	VINTAGE 2.0	20576	(*)	
SVARTPILEN 401	17' - 21'	VINTAGE 2.0	20576	(*)	
VITPILEN 401	17' - 21'	VINTAGE 2.0	20576	(*)	
HYOSUNG					
GT650R	06' - 12'	R12	6402	(*)	

N Black

(-) Supplied with holesaw to drill bodywork.

(*) Check price with your distributor.

IMPORTANT: Indicate code color after part#. Example 0973A.

FRAME SLIDERS

HI-TECH PARTS | TYPE OF FRAME SLIDERS:

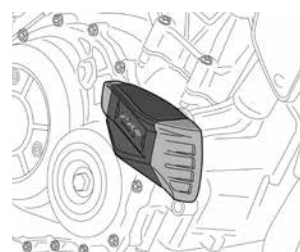

FRAME SLIDER PRO 2.0

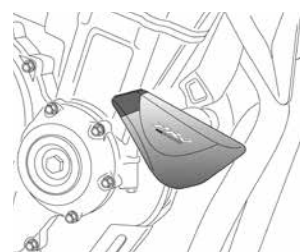

FRAME SLIDER PRO

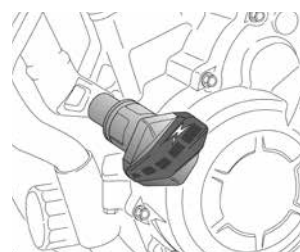

FRAME SLIDER R19



FRAME SLIDER VINTAGE

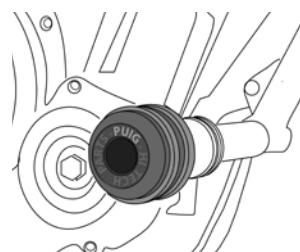

FRAME SLIDER VINTAGE 2.0

2022		For the new 2022 motorcycle models check www.puig.tv			
MODEL	YEAR	TYPE OF FRAME SLIDER	REFERENCE	N	
INDIAN					
FTR 1200	19' - 21'	VINTAGE 2.0	20463	(*)	
FTR 1200S	19' - 21'	VINTAGE 2.0	20463	(*)	
KAWASAKI					
ER-6N	05' - 08'	R19	4069	(*)	
ER-6N	09' - 11'	R19	4964	(*)	
ER-6N	12' - 16'	R19	6054	(*)	
ER-6F	09' - 11'	R19	4965	(*)	
ER-6F	12' - 16'	PRO	6068	(*)	
ER-6F	12' - 16'	R19	6055	(*)	
KLV1000	04' - 05'	R12	1871	(*)	
NINJA 125	19' - 21'	R19	3538	(*)	
NINJA 250R	08' - 12'	R19	5170	(*)	
NINJA 300	13' - 17'	R19	6562	(*)	
NINJA 400	18' - 21'	R19	9628	(*)	
NINJA 650	17' - 21'	R19	9466	(*)	
NINJA 650	17' - 21'	PRO	9467	(*)	
NINJA 1000SX	20' - 21'	PRO	9400	(*)	
NINJA H2 SX	18' - 21'	R19	9708	(*)	
VERSYS 650	10' - 14'	PRO	5289	(*)	
VERSYS 650	15' - 21'	PRO	7702	(*)	
VERSYS 650	15' - 21'	R19	7714	(*)	
VERSYS 1000	15' - 20'	PRO	7071	(*)	
Z250SL	15' - 16'	R19	7716	(*)	
Z300	15' - 17'	R12	7717	(*)	
Z400	19' - 21'	R19	3546	(*)	
Z650	17' - 21'	PRO	9354	(*)	
Z650	17' - 21'	R19	9355	(*)	
Z750	04' - 06'	R19	1860	(*)	
Z750	07' - 12'	PRO	5290	(*)	
Z750	07' - 12'	R19	4527	(*)	

2022		For the new 2022 motorcycle models check www.puig.tv			
MODEL	YEAR	TYPE OF FRAME SLIDER	REFERENCE	N	
Z750S	05' - 06'	R19	1860	(*)	
Z750R	11' - 12'	PRO	5290	(*)	
Z750R	11' - 12'	R19	4527	(*)	
Z800	13' - 16'	PRO	6471	(*)	
Z800E	13' - 16'	PRO	6471	(*)	
Z800	13' - 16'	R19	6563	(*)	
Z800E	13' - 16'	R19	6563	(*)	
Z900	17' - 21'	R19	9389	(*)	
Z900	17' - 21'	PRO	9390	(*)	
Z900RS	18' - 21'	VINTAGE	9598	(*)	
Z900RS CAFÉ	18' - 21'	VINTAGE	9598	(*)	
Z1000	03' - 06'	R19	1860	(*)	
Z1000	07' - 09'	R19	4527	(*)	
Z1000	07' - 09'	PRO	5290	(*)	
Z1000	14' - 21'	R19	7059	(*)	
Z1000	14' - 21'	PRO	7071	(*)	
Z1000R	17' - 21'	R19	7059	(*)	
Z1000R	17' - 21'	PRO	7071	(*)	
Z1000SX	11' - 13'	PRO	5689	(*)	
Z1000SX	14' - 16'	PRO	5689	(*)	
Z1000SX	17' - 19'	PRO	9400	(*)	
ZH2	20' - 21'	R19	9708	(*)	
Z H2 SE	20' - 21'	R19	9708	(*)	
ZX-6R	18' - 21'	PRO	3181	(*)	
ZX-6R	18' - 21'	R19	3182	(*)	
ZX-6R 636	13' - 16'	PRO	6472	(*)	
ZX-10R	11' - 21'	R19	5702	(*)	
ZX-10R	11' - 21'	PRO	5690	(*)	
ZX-10RR	17' - 21'	R19	5702	(*)	
ZX-10RR	17' - 21'	PRO	5690	(*)	
ZX-10R SE	18' - 20'	R19	5702	(*)	
ZX-10R SE	18' - 20'	PRO	5690	(*)	
ZZR1400	12' - 21'	R19	6056	(*)	
KEEWAY					
RKF 125	18' - 21'	R19	20813	(*)	
KTM					
125 DUKE	11' - 16'	R19	5700	(*)	
125 DUKE	17' - 21'	R19	6565	(*)	
200 DUKE	12' - 15'	R19	5700	(*)	

N Black

(-) Supplied with holesaw to drill bodywork.

(*) Check price with your distributor.

IMPORTANT: Indicate code color after part#. Example 0973A.

FRAME SLIDERS

HI-TECH PARTS | TYPE OF FRAME SLIDERS:

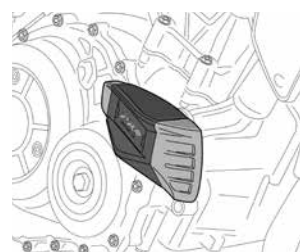

FRAME SLIDER PRO 2.0

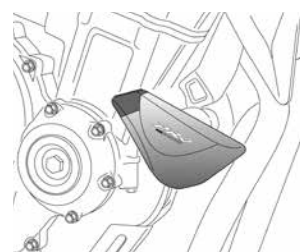

FRAME SLIDER PRO

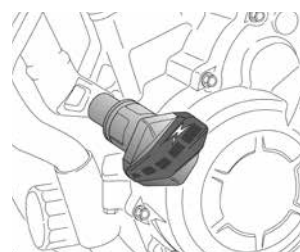

FRAME SLIDER R19



FRAME SLIDER VINTAGE

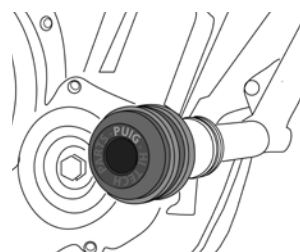

FRAME SLIDER VINTAGE 2.0

2022		For the new 2022 motorcycle models check www.puig.tv			
MODEL	YEAR	TYPE OF FRAME SLIDER	REFERENCE	N	
390 DUKE	13' - 21'	R19	6565	(*)	
790 DUKE	18' - 21'	R19	9674	(*)	
890 DUKE R	20' - 21'	R19	9674	(*)	
1290 SUPERDUKE GT	16' - 21'	R19	7063	(*)	
1290 SUPERDUKE R	14' - 19'	R19	7063	(*)	
1290 SUPERDUKE R	20' - 21'	R19	20450	(*)	
1290 SUPERDUKE R	20' - 21'	PRO	20451	(*)	
MV AGUSTA					
BRUTALE 800/RR	17' - 21'	R19	9853	(*)	
BRUTALE DRAGSTER 800/RR	17' - 21'	R19	9853	(*)	
TURISMO VELOCE 800	17' - 21'	R19	9853	(*)	
TURISMO VELOCE 800 LUSO	17' - 21'	R19	9853	(*)	
SUZUKI					
DL650 V-STROM	04' - 21'	R19	1870	(*)	
DL650XT V-STROM	15' - 21'	R19	1870	(*)	
DL1000 V-STROM	02' - 07'	R12	1871	(*)	
GSF650 BANDIT	05' - 06'	R19	3918	(*)	
GSF650 BANDIT	07' - 11'	R19	4428	(*)	
GSF650S BANDIT	05' - 06'	R19	3918	(*)	
GSF650S BANDIT	07' - 14'	R19	4428	(*)	
GSF1250 BANDIT	07' - 13'	R19	4428	(*)	
GSF1250S BANDIT	07' - 13'	R19	4428	(*)	
GSR600	06' - 11'	R19	4067	(*)	
GSR750	11' - 16'	PRO	5687	(*)	
GSR750	11' - 16'	R19	5698	(*)	
GSX-R600	01' - 03'	R19	1971	(*)	
GSX-R600	04' - 05'	R19	1865	(*)	
GSX-R600	06' - 07'	R19	4066	(*)	
GSX-R600	08' - 10'	R19	4652	(*)	
GSX-R600	11' - 16'	PRO	5686	(*)	
GSX-R750	00' - 03'	R19	1971	(*)	

2022		For the new 2022 motorcycle models check www.puig.tv			
MODEL	YEAR	TYPE OF FRAME SLIDER	REFERENCE	N	
GSX-R750	04' - 05'	R19	1865	(*)	
GSX-R750	06' - 07'	R12	4066	(*)	
GSX-R750	08' - 10'	R19	4652	(*)	
GSX-R750	11' - 16'	PRO	5686	(*)	
GSX-S750	17' - 21'	R19	5698	(*)	
GSX-S750	17' - 21'	PRO	5687	(*)	
GSX-R1000	07' - 08'	R19	4426	(*)	
GSX-R1000	09' - 16'	PRO	5295	(*)	
GSX-R1000/R	17' - 20'	R19	9000	(*)	
GSX-R1000/R	17' - 20'	PRO	9370	(*)	
GSX-S125	17' - 19'	R19	9960	(*)	
GSX-S125	20' - 21'	R19	20353	(*)	
GSX-S950	22'	R19	7721	(*)	
GSX-S950	22'	PRO	7704	(*)	
GSX-S1000	15' - 22'	R19	7721	(*)	
GSX-S1000	15' - 22'	PRO	7704	(*)	
GSX-S1000F	15' - 21'	PRO	7705	(*)	
KATANA	19' - 21'	R19	7721	(*)	
KATANA	19' - 21'	PRO	7704	(*)	
SFV650 GLADIUS	09' - 15'	R19	4962	(*)	
SV650	03' - 06'	R19	1867	(*)	
SV650S	03' - 08'	R19	1867	(*)	
SV650	16' - 21'	R19	4962	(*)	
SV650X	18' - 21'	R19	4962	(*)	
TRIUMPH					
BONNEVILLE T100	16' - 19'	VINTAGE	8588	(*)	
BONNEVILLE T120	16' - 19'	VINTAGE	8588	(*)	
BONNEVILLE BOBBER	17' - 21'	VINTAGE	8588	(*)	
BONNEVILLE BOBBER BLACK	20' - 21'	VINTAGE	8588	(*)	
DAYTONA 675	06' - 12'	R19	4631	(*)	
SCRAMBLER 1200XC	19' - 21'	VINTAGE	3627	(*)	
SCRAMBLER 1200XE	19' - 21'	VINTAGE	3627	(*)	
SPEED TWIN	19' - 21'	VINTAGE	3582	(*)	
STREET TRIPLE	07' - 12'	R19	4631	(*)	
STREET TRIPLE	20' - 21'	R19	6571	(*)	
STREET TRIPLE R	09' - 12'	R19	4631	(*)	
STREET CUP	17' - 20'	VINTAGE	8588	(*)	
STREET SCRAMBLER	17' - 21'	VINTAGE	3627	(*)	
STREET TWIN	16' - 21'	VINTAGE	8588	(*)	

N Black

(-) Supplied with holesaw to drill bodywork.

(*) Check price with your distributor.

IMPORTANT: Indicate code color after part#. Example 0973A.

FRAME SLIDERS

HI-TECH PARTS | TYPE OF FRAME SLIDERS:

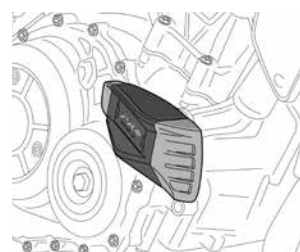

FRAME SLIDER PRO 2.0

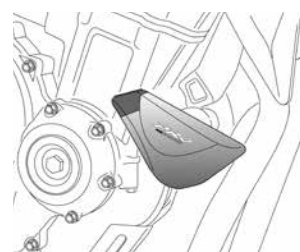

FRAME SLIDER PRO

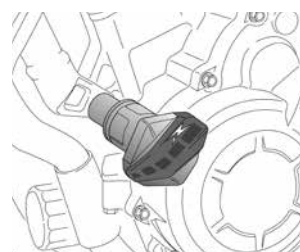

FRAME SLIDER R19

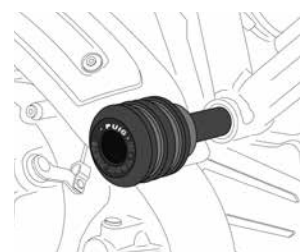

FRAME SLIDER VINTAGE

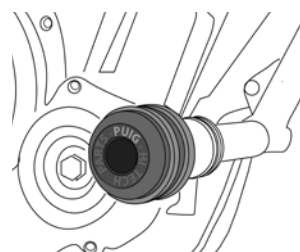

FRAME SLIDER VINTAGE 2.0

2022		For the new 2022 motorcycle models check www.puig.tv			
MODEL	YEAR	TYPE OF FRAME SLIDER	REFERENCE	N	
TRIDENT 660	21'	VINTAGE 2.0	20631	(*)	
THRUXTON 1200/R	16' - 20'	VINTAGE	8588	(*)	
THRUXTON 1200RS	20' - 21'	VINTAGE	8588	(*)	
YAMAHA					
FAZER8	13' - 16'	R19	5584	(*)	
FJR1300A/AS	06' - 12'	R19	4086	(*)	
FJR1300A/AS	13' - 17'	R19	6572	(*)	
FZ1	06' - 15'	R19	5584	(*)	
FZ1 FAZER	06' - 15'	R19	5584	(*)	
FZ6	04' - 08'	R19	1873	(*)	
FZ6 FAZER	04' - 08'	R19	1873	(*)	
FZ6 FAZER S2	07' - 10'	R19	1873	(*)	
FZ8	10' - 16'	R19	5584	(*)	
FZ8 FAZER	10' - 12'	R19	5584	(*)	
MT-125	15' - 19'	R19	7723	(*)	
MT-125	20' - 21'	R19	3885	(*)	
MT-03	16' - 21'	R19	8589	(*)	
MT-03	16' - 21'	PRO	8590	(*)	
MT-07	14' - 21'	R19	7064	(*)	
MT-07	14' - 21'	PRO	7074	(*)	
MT-07 TRACER	16' - 19'	R19	7064	(*)	
MT-07 TRACER	20' - 21'	R19	7064	(*)	
MT-07 TRACER	16' - 19'	PRO	7074	(*)	
MT-07 TRACER GT	19' - 21'	R19	7064	(*)	
MT-07 TRACER GT	19'	PRO	7074	(*)	
MT-09	13' - 16'	R19	6857	(*)	
MT-09	13' - 16'	PRO	7316	(*)	
MT-09	17' - 20'	R19	9380	(*)	
MT-09	17' - 20'	PRO	7316	(*)	
MT-09	21'	R19	20669	(*)	
MT-09	21'	PRO	20670	(*)	

2022		For the new 2022 motorcycle models check www.puig.tv			
MODEL	YEAR	TYPE OF FRAME SLIDER	REFERENCE	N	
MT-09 SP	18' - 20'	R19	9380	(*)	
MT-09 SP	18' - 20'	PRO	7316	(*)	
MT-09 SP	21'	R19	20669	(*)	
MT-09 SP	21'	PRO	20670	(*)	
MT-09 TRACER	15' - 20'	R19	6857	(*)	
MT-09 TRACER	15' - 20'	PRO	7316	(*)	
MT-09 TRACER	21'	R19	20669	(*)	
MT-09 TRACER	21'	PRO	20670	(*)	
MT-09 TRACER GT	18' - 20'	R19	6857	(*)	
MT-09 TRACER GT	18' - 20'	PRO	7316	(*)	
MT-09 TRACER GT	21'	R19	20669	(*)	
MT-09 TRACER GT	21'	PRO	20670	(*)	
MT-10	16' - 21'	R19	7724	(*)	
MT-10	16' - 21'	PRO	8592	(*)	
MT-10 SP	17' - 21'	R19	7724	(*)	
MT-10 SP	17' - 21'	PRO	8592	(*)	
XJ6	09' - 16'	R19	4948	(*)	
XJ6 DIVERSION	09' - 16'	R19	4948	(*)	
XSR 125	21'	VINTAGE 2.0	20398	(*)	
XSR 700	16' - 21'	PRO	7074	(*)	
XSR 700	16' - 21'	VINTAGE	8593	(*)	
XSR 700 XTRIBUTE	19' - 21'	PRO	7074	(*)	
XSR 700 XTRIBUTE	19' - 21'	VINTAGE	8593	(*)	
XSR 900	16' - 21'	PRO	7316	(*)	
XSR 900	16' - 21'	VINTAGE	8594	(*)	
YZF-R1	04' - 06'	R19	1878	(*)	
YZF-R1 SP	06'	R19	1878	(*)	
YZF-R1	14' - 21'	R19	7724	(*)	
YZF-R1	14' - 21'	PRO	7706	(*)	
YZF-R1M	17' - 21'	R19	7724	(*)	
YZF-R1M	17' - 21'	PRO	7706	(*)	
YZF-R3	15' - 18'	R19	7725	(*)	
YZF-R6	03' - 05'	R12	1877	(*)	
YZF-R6	06' - 07'	R19	4064	(*)	
YZF-R6	08' - 16'	R19	4650	(*)	

N Black

(-) Supplied with holesaw to drill bodywork.

(*) Check price with your distributor.

IMPORTANT: Indicate code color after part#. Example 0973A.



ENGINE GUARDS

HI-TECH PARTS | TECHNICAL SECTION



2022

For the new 2022 motorcycle models check www.puig.tv

MODEL	YEAR	Ø	REF.	N	U
BMW					
F650 GS	08' - 12'	25 mm.	5983	(*)	
F700 GS	12' - 17'	25 mm.	5983	(*)	
F750GS	18' - 21'	25 mm.	9780	(*)	
F800 GS	08' - 12'	25 mm.	5983	(*)	
F800 GS	13' - 17'	25 mm.	6537	(*)	
F850GS	18' - 21'	25 mm.	9780	(*)	
R1200GS - LOW	13'	25 mm.	6538	(*)	(*)
R1200GS - HIGH	14' - 16'	25 mm.	7542	(*)	(*)
R1200GS - LOW	14' - 16'	25 mm.	7543	(*)	(*)
R1200GS - HIGH	17' - 18'	25 mm.	9461	(*)	(*)
R1200GS - LOW	17' - 18'	25 mm.	7543	(*)	(*)
R1200GS RALLYE/EXCLUSIVE-HIGH	17' - 18'	25 mm.	9461	(*)	(*)
R1200GS RALLYE/EXCLUSIVE-LOW	17' - 18'	25 mm.	7543	(*)	(*)
R1200R	15' - 18'	25 mm.	7768	(*)	
R1200RS	15' - 18'	25 mm.	7768	(*)	
R1250GS - HIGH	18' - 20'	25 mm.	9461	(*)	(*)
R1250GS - LOW	18' - 20'	25 mm.	2249	(*)	(*)
R1250GS HP - HIGH	18' - 20'	25 mm.	9461	(*)	(*)
R1250GS HP - LOW	18' - 20'	25 mm.	2249	(*)	(*)
R1250GS RALLYE - HIGH	18' - 20'	25 mm.	9461	(*)	(*)
R1250GS RALLYE - LOW	18' - 20'	25 mm.	2249	(*)	(*)
R NINE T	14' - 21'	25 mm.	7095	(*)	
R NINE T SCRAMBLER	16' - 21'	25 mm.	7095	(*)	
R NINE T RACER	17' - 20'	25 mm.	7095	(*)	
R NINE T PURE	17' - 21'	25 mm.	7095	(*)	
R NINE T URBAN G/S	17' - 21'	25 mm.	7095	(*)	
DUCATI					
MULTISTRADA V4	21'	25 mm.	20267	(*)	
MULTISTRADA V4S/S SPORT	21'	25 mm.	20267	(*)	
HARLEY DAVIDSON					
SPORTSTER IRON XL883N	09' - 21'	32 mm.	21037	(*)	
SPORTSTER IRON 1200 XL1200NS	18' - 21'	32 mm.	21037	(*)	
SPORTSTER LOW XL883L	05' - 10'	32 mm.	21037	(*)	

-  N Black
-  U Grey

NOTE: PREVIOUSLY VERIFY ANY INTERFERENCE BETWEEN OUR PRODUCT AND ANY OTHER ACCESSORY (OEM OR AFTERMARKET) ALREADY INSTALLED ON THE MOTORCYCLE

(#) Compatible con los modelos DCT.

(*) Check price with your distributor.

IMPORTANT: Indicate code color after part#. Example 0973A.

2022		For the new 2022 motorcycle models check www.puig.tv				
MODEL	YEAR	Ø	REF.	N	U	
SPORTSTER 1200 NIGHTSTER XL1200N	07' - 12'	32 mm.	21037	(*)		
SPORTSTER 1200 SEVENTY TWO XL1200V	12' - 16'	32 mm.	21037	(*)		
SPORTSTER FORTY-EIGHT SPECIAL XL1200XS	18' - 21'	32 mm.	21037	(*)		
SPORTSTER 1200 ROADSTER XL1200R	04' - 08'	32 mm.	21037	(*)		
SPORTSTER 1200 ROADSTER XL1200CX	11' - 18'	32 mm.	21037	(*)		
PAN AMERICA 1250	21'	32 mm.	20991	(*)		
HONDA						
CB500F/X	13' - 18'	25 mm.	6539	(*)		
CB500F	19' - 21'	25 mm.	6539	(*)		
CMX 500 REBEL	17' - 21'	25 mm.	3742	(*)		
CMX 500 REBEL S	20' - 21'	25 mm.	3742	(*)		
CMX 1100 REBEL	21'	25 mm.	20261	(*)		
NC700S/X	12' - 13'	25 mm.	6387(#)	(*)		
NC750S/X	14' - 20'	25 mm.	6387(#)	(*)		
NC750S	21'	25 mm.	6387(#)	(*)		
X-ADV	21'	25 mm.	20581	(*)		
INDIAN						
SCOUT	15' - 21'	38 mm.	21040	(*)		
SCOUT BOBBER	18' - 21'	38 mm.	21040	(*)		
SCOUT BOBBER SIXTY	16' - 21'	38 mm.	21040	(*)		
SCOUT BOBBER TWENTY	16' - 21'	38 mm.	21040	(*)		
SCOUT SIXTY	16' - 21'	38 mm.	21040	(*)		
KAWASAKI						
VERSYS 650	15' - 21'	25 mm.	7773	(*)		
VULCAN S	15' - 21'	25 mm.	8544	(*)		
VULCAN S CAFE	17' - 20'	32 mm.	8544	(*)		
SUZUKI						
DL650 V-STROM	12' - 21'	25 mm.	5884	(*)		
DL650XT V-STROM	15' - 16'	25 mm.	5884	(*)		
DL1050 V-STROM	20' - 21'	25 mm.	20404	(*)		
DL1050XT V-STROM	20' - 21'	25 mm.	20404	(*)		
TRIUMPH						
TIGER 900	20' - 21'	25 mm.	20384	(*)		
TIGER 900 GT	20' - 21'	25 mm.	20384	(*)		
TIGER 900 GT LOW	20' - 21'	25 mm.	20384	(*)		
TIGER 900 GT PRO	20' - 21'	25 mm.	20384	(*)		
TIGER 900 RALLY	20' - 21'	25 mm.	20384	(*)		
TIGER 900 RALLY PRO	20' - 21'	25 mm.	20384	(*)		
YAMAHA						
MT-07 TRACER	20' - 21'	25 mm.	20443	(*)		
MT-07 TRACER GT	20' - 21'	25 mm.	20443	(*)		

2022		For the new 2022 motorcycle models check www.puig.tv				
MODEL	YEAR	Ø	REF.	N	U	
MT-09 TRACER	15' - 17'	25 mm.	7777	(*)		
MT-09 TRACER	18' - 20'	25 mm.	9720	(*)		
MT-09 TRACER	21'	25 mm.	20837	(*)		
MT-09 TRACER GT	18' - 20'	25 mm.	9720	(*)		
MT-09 TRACER GT	21'	25 mm.	20837	(*)		
TENERE 700	19' - 21'	25 mm.	3814	(*)		
XV950	13' - 16'	38 mm.	21041	(*)		
XV950 R	17' - 21'	38 mm.	21041	(*)		
XV950 RACER	16' - 17'	38 mm.	21041	(*)		

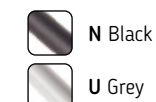

NOTE: PREVIOUSLY VERIFY ANY INTERFERENCE BETWEEN OUR PRODUCT AND ANY OTHER ACCESSORY (OEM OR AFTERMARKET) ALREADY INSTALLED ON THE MOTORCYCLE

(#) Compatible con los modelos DCT.

(*) Check price with your distributor.

IMPORTANT: Indicate code color after part#. Example 0973A.

FRAME SLIDERS OPIE

HI-TECH PARTS | TECHNICAL SECTION



REF. 21043N

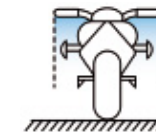

DESIGN

Sliders do not stand out from handlebar and touch after the footpegs.



COMPLETE PROTECTION

Protect engine and chassis.



DIMENSIONS

RUBBER RINGS AVAILABLE IN VARIOUS COLORS



N Black

MODEL	YEAR	REF.	N
HARLEY DAVIDSON			
SOFTAIL LOW RIDER FXLR	18' - 20'	21043N	(*)
SOFTAIL LOW RIDER S FXLRS	20' - 21'	21043N	(*)
SOFTAIL STREET BOB FXBB	18' - 21'	21043N	(*)
SOFTAIL STANDARD FXST	21'	21043N	(*)
DYNA LOW RIDER FXDL	93' - 09'	21044N	(*)
DYNA LOW RIDER FXDL	14' - 15'	21044N	(*)
DYNA LOW RIDER S FXDLS	16' - 17'	21044N	(*)
DYNA STREET BOB FXDB/I	06' - 17'	21044N	(*)
DYNA SUPER GLIDE FXD	95' - 10'	21044N	(*)
DYNA SUPER GLIDE FXDC	05' - 14'	21044N	(*)
DYNA SUPER GLIDE SPORT FXDX	99' - 05'	21044N	(*)

SPARES	REF.	A	B	R	U	V	N
RUBBER RINGS PROTECTOR VINTAGE 2.0. BY PAIR	3667						(*)

(*) Check price with your distributor.
 IMPORTANT: Indicate code color after part#. Example 0973A.

ENGINE PROTECTIVE COVERS

HI-TECH PARTS | TECHNICAL SECTION



REF. 20134N

MATERIAL

Manufactured in 4 mm. thick polypropylene for strength, durability and good appearance. The covers are simply bolt-on on the oem engine case.

Compact for a maximum distance to the ground, matt finished, and protecting one of the most vulnerable areas of the machine.

2022 For the new 2022 motorcycle models check www.puig.tv

MODEL	YEAR	REF.	PIECES	N
BMW				
S1000R	09' - 16'	20168	3	(*)
S1000R	17' - 19'	20137	3	(*)
S1000R	20' - 21'	20215	3	(*)
S1000RR	09' - 14'	20168	3	(*)
S1000RR	15' - 18'	20137	3	(*)
S1000RR	19' - 21'	20215	3	(*)
S1000XR	15' - 19'	20137	3	(*)
S1000XR	20' - 21'	20215	3	(*)
DUCATI				
1199 PANGALE	12' - 15'	20138	2	(*)
1299 PANIGALE	15' - 17'	20138	2	(*)
PANIGALE 1100 V4	18' - 21'	20139	2	(*)
PANIGALE 1100 V4 SP	21'	20139	2	(*)
PANIGALE 1100 V4R	19' - 21'	20139	2	(*)
PANIGALE 1100 V4S	18' - 21'	20139	2	(*)
STREETFIGHTER V4 / V4S	20' - 21'	20800	2	(*)
HONDA				
CB650R NEO SPORT CAFÉ	19' - 20'	20625	3	(*)
CB650R	19' - 20'	20625	3	(*)

N Black

2022 For the new 2022 motorcycle models check www.puig.tv

MODEL	YEAR	REF.	PIECES	N
CBR600RR	07' - 16'	20121	3	(*)
CBR1000RR FIREBLADE	08' - 16'	20122	3	(*)
CBR1000RR FIREBLADE/SP/SP2	17' - 19'	20289	3	(*)
KAWASAKI				
ER-6N	06' - 16'	20134	3	(*)
NINJA 250SL	15' - 16'	20131	2	(*)
NINJA 300	14' - 17'	20131	2	(*)
NINJA 400	18' - 21'	20169	3	(*)
Z250	14' - 16'	20131	2	(*)
Z300	15' - 17'	20131	2	(*)
Z800	13' - 16'	20136	3	(*)
Z800E	13' - 16'	20136	3	(*)
Z900	17' - 21'	20135	3	(*)
Z1000	14' - 20'	20417	3	(*)
ZX-6R	09' - 16'	20132	3	(*)
ZX-6R	18' - 21'	20132	3	(*)
ZX-6R 636	13' - 17'	20132	3	(*)
ZX-10R	11' - 20'	20133	3	(*)
ZX-10RR	17' - 20'	20133	3	(*)
KTM				
390 DUKE	14' - 15'	20140	2	(*)
390 DUKE	16' - 19'	20141	2	(*)
790 DUKE	18' - 21'	20221	3	(*)
RC390	17' - 19'	20141	2	(*)
RC390	16' - 17'	20140	2	(*)
SUZUKI				
GSX-R600/750	11' - 16'	20124	3	(*)
GSX-R1000	09' - 16'	20125	3	(*)
GSX-R1000/R	17' - 20'	20126	3	(*)
YAMAHA				
NIKEN	18' - 21'	20128	3	(*)
MT-09	14' - 21'	20128	3	(*)
MT-09 SP	18' - 20'	20128	3	(*)
MT-09 TRACER	15' - 20'	20128	3	(*)
MT-09 TRACER GT	18' - 20'	20128	3	(*)
MT-10	16' - 21'	20142	3	(*)
YZF-R1	15' - 21'	20127	3	(*)
YZF-R1M	17' - 21'	20127	3	(*)
YZF-R3	16' - 21'	20130	3	(*)
YZF-R6	06' - 20'	20129	3	(*)

(*) Check price with your distributor.

IMPORTANT: Indicate code color after part#. Example 0973A.



ALUMINIUM FILTER COVER, CLUTCH COVER AND SPROCKET COVER



HI-TECH PARTS | TECHNICAL SECTION

REF. 9993N



ALUMINIUM FILTER COVER

MODEL	YEAR	REF.	N
HARLEY DAVIDSON			
SPORTSTER 883 IRON	16' - 20'	9993	(*)

REF. 9855N



CLUTCH COVER

MODEL	YEAR	REF.	A N O R P
YAMAHA			
T-MAX 530	12' - 16'	8501	(*)
T-MAX 530/DX/SX	17' - 19'	9855	(*)
T-MAX 560 /SX/DX/MAX TECH	20' - 21'	9855	(*)

REF. 8502O



SPROCKET COVER

MODEL	YEAR	REF.	A N O R P
KYMCO			
AK550	17' - 21'	9547	(*)
YAMAHA			
T-MAX 530	12' - 16'	8502	(*)
T-MAX/DX/SX	17' - 19'	8502	(*)
T-MAX 560 /SX/DX/MAX TECH	20' - 21'	8502	(*)

- A Blue
- R Red
- P Silver
- N Black
- O Gold

(*) Check price with your distributor.
 IMPORTANT: Indicate code color after part#. Example 0973A.



SIDE PANELS

HI-TECH PARTS | TECHNICAL SECTION



1 REF. 9590P
MATERIAL: Aluminium

2 REF. 8562J
MATERIAL: ABS

RETRO SIDE PANELS

2022 For the new 2022 motorcycle models check www.puig.tv

MODEL	YEAR	REF.	J	C	P
BMW					
R NINE T (1)	14' - 21'	9590			(*)
R NINE T SCRAMBLER (1)	16' - 21'	9590			(*)
R NINE T PURE (1)	17' - 21'	9590			(*)
R NINE T RACER (1)	17' - 20'	9590			(*)
R NINE T URBAN G/S (1)	17' - 21'	9590			(*)
YAMAHA					
XSR700 (2)	16' - 21'	8562 (#)			(*)
XSR700 XTRIBUTE (2)	19' - 21'	8562 (#)			(*)
XSR900 (2)	16' - 19'	8563 (#)			(*)
UNIVERSAL					
PLASTICS UNIVERSAL SIDE COVERS WITHOUT FITTINGS		9232	(*)	(*)	
PLASTICS SCRAMBLER SIDE COVERS WITHOUT FITTINGS		20301	(*)		
UNIVERSAL ALUMINIUM SIDE COVERS WITHOUT FITTINGS		9599			(*)



CLEAN
Protect the rider and motorcycle from dirt on all type of roads.



DESIGN
Covers empty areas of the motorcycles.

- J Matt black
- U Grey
- C Carbon look
- N Black
- P Aluminium



REF. 6805J

SIDE PANELS

2022 For the new 2022 motorcycle models check www.puig.tv

MODEL	YEAR	REF.	J	C	U	N
BMW						
F750 GS	18' - 21'	9791	(*)			
F850 GS	18' - 21'	9791	(*)			
F850 GS ADVENTURE	19' - 21'	3596	(*)			
R1200 GS	13' - 18'	6805	(*)			(*)
R1200 GS ADVENTURE	14' - 18'	7518	(*)			(*)
R1200GS EXCLUSIVE	17' - 18'	6805	(*)			(*)
R1200GS RALLYE	17' - 18'	6805	(*)			(*)
R1200 RT	05' - 13'	6367	(*)			(*)
R1250GS	18' - 21'	6805	(*)			(*)
R1250GS ADVENTURE	18' - 20'	7518	(*)			(*)
R1250GS HP	18' - 21'	6805	(*)			(*)
R1250GS RALLYE	18' - 21'	6805	(*)			(*)
S1000RR	19' - 21'	3833				(*)
HONDA						
CRF1100L AFRICA TWIN	20' - 21'	3822	(*)			
CRF1100L AFRICA TWIN ADVENTURE SPORTS	20' - 21'	3822	(*)			
KTM						
1050 ADVENTURE	15' - 16'	7513	(*)			
1090 ADVENTURE/R	17' - 20'	7513	(*)			
1190 ADVENTURE/R	13' - 16'	7513	(*)			
1290 SUPER ADVENTURE	15' - 16'	7513	(*)			
1290 SUPER ADVENTURE R/S	17' - 20'	7513	(*)			
1290 SUPER ADVENTURE T	17'	7513	(*)			
YAMAHA						
XT1200Z SUPER TÉNÉRÉ	10' - 21'	6804	(*)			
XT1200ZE SUPER TENERE	19' - 21'	6804	(*)			
SPARES						
MT-09 SIDE COVERS		9233	(*)	(*)		
R1200GS SIDE COVERS		9234	(*)			

(#) ADHESIVE KIT INCLUDED.

(*) Check price with your distributor.

IMPORTANT: Indicate code color after part#. Example 0973A.

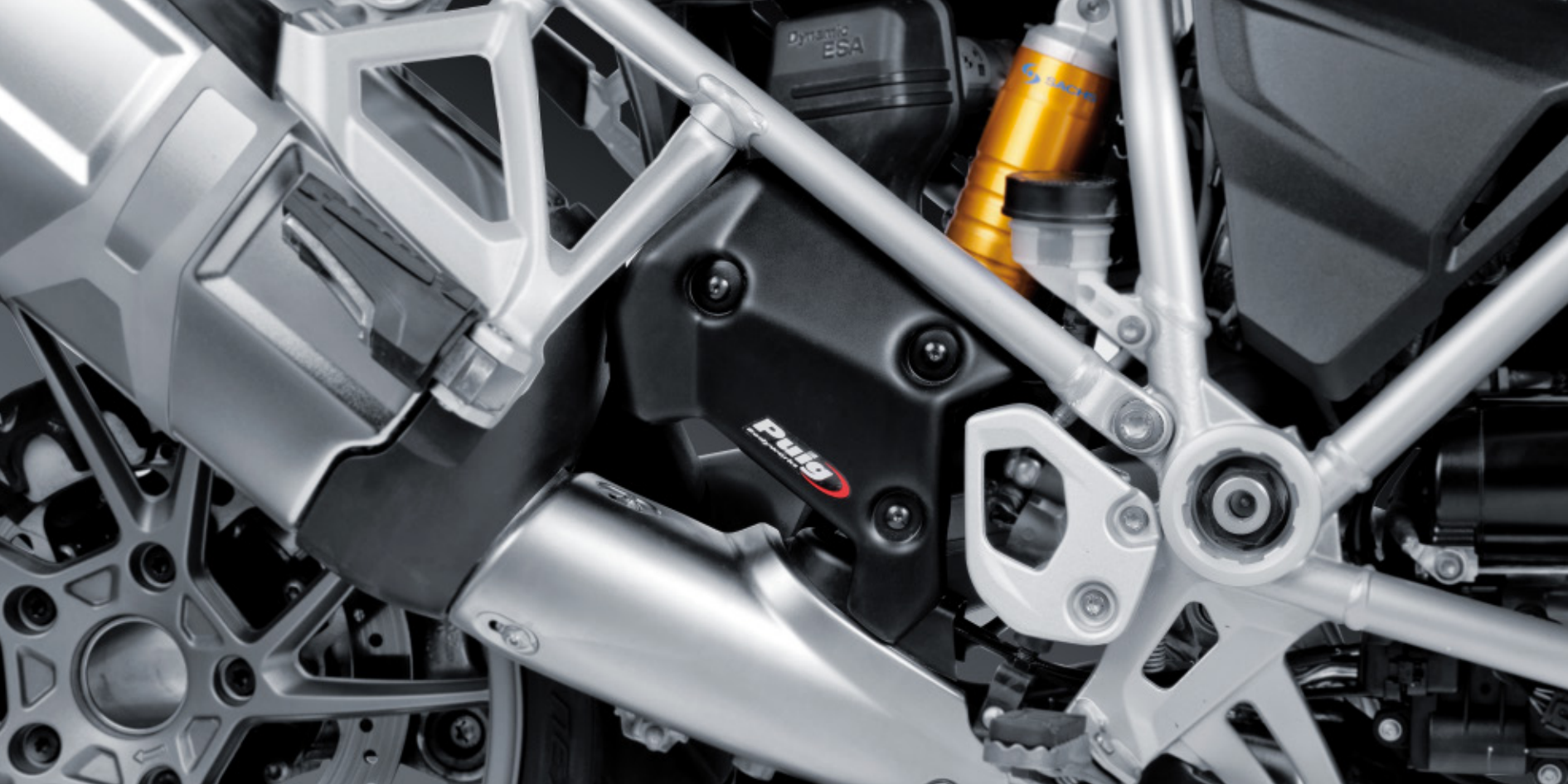

REAR DEFLECTORS

HI-TECH PARTS | TECHNICAL SECTION

MODEL	YEAR	REF.	J	C	U
BMW					
R1200 GS	04' - 12'	6802	(*)	(*)	(*)
R1200 GS	13' - 18'	6869	(*)	(*)	(*)
R1200 GS ADVENTURE	06' - 13'	6802	(*)	(*)	(*)
R1200 GS ADVENTURE	14' - 18'	6869	(*)	(*)	(*)
R1200GS EXCLUSIVE	17' - 18'	6869	(*)	(*)	(*)
R1200GS RALLYE	17' - 18'	6869	(*)	(*)	(*)
R1250GS	18' - 21'	6869	(*)	(*)	(*)
R1250 GS ADVENTURE	18' - 21'	6869	(*)	(*)	(*)
R1250 GS HP	18' - 21'	6869	(*)	(*)	(*)
R1250 GS RALLYE	18' - 21'	6869	(*)	(*)	(*)

U Grey
 J Matt black
 C Carbon look



REF. 6869J

(*) Check price with your distributor.
 IMPORTANT: Indicate code color after part#. Example 0973A.

REAR BRAKE TANK COVER

HI-TECH PARTS | TECHNICAL SECTION

MODEL	YEAR	REF.	J	C
YAMAHA				
MT-07	14' - 20'	7578	(*)	(*)
MT-09	13' - 20'	7578	(*)	(*)
MT-09 SP	18' - 20'	7578	(*)	(*)
MT-07 TRACER	16' - 21'	7578	(*)	(*)
MT-07 TRACER GT	19' - 21'	7578	(*)	(*)
MT-09 TRACER	15' - 20'	8542	(*)	(*)
MT-09 TRACER GT	18' - 20'	8542	(*)	(*)

J Matt black
 C Carbon look



REF. 7578J

(*) Check price with your distributor.
 IMPORTANT: Indicate code color after part#. Example 0973A.



INTAKE COVER

HI-TECH PARTS | TECHNICAL SECTION

MODEL	YEAR	REF.	N
BMW			
R1200 GS	13' - 18'	9175	(*)
R1200GS EXCLUSIVE	17' - 18'	9175	(*)
R1200GS RALLYE	17' - 18'	9175	(*)
R1250GS	18' - 21'	9175	(*)
R1250 GS HP	18' - 21'	9175	(*)
R1250 GS RALLYE	18' - 21'	9175	(*)



REF. 9175N

N Black

(*) Check price with your distributor.
IMPORTANT: Indicate code color after part#. Example 0973A.

REAR LUGGAGE SUPPORT COVERS

HI-TECH PARTS | TECHNICAL SECTION

MODEL	YEAR	REF.	J	C
YAMAHA				
MT-09 TRACER	15' - 17'	8089	(*)	(*)



REF. 8089J

J Matt black

C Carbon look

(*) Check price with your distributor.
IMPORTANT: Indicate code color after part#. Example 0973A.

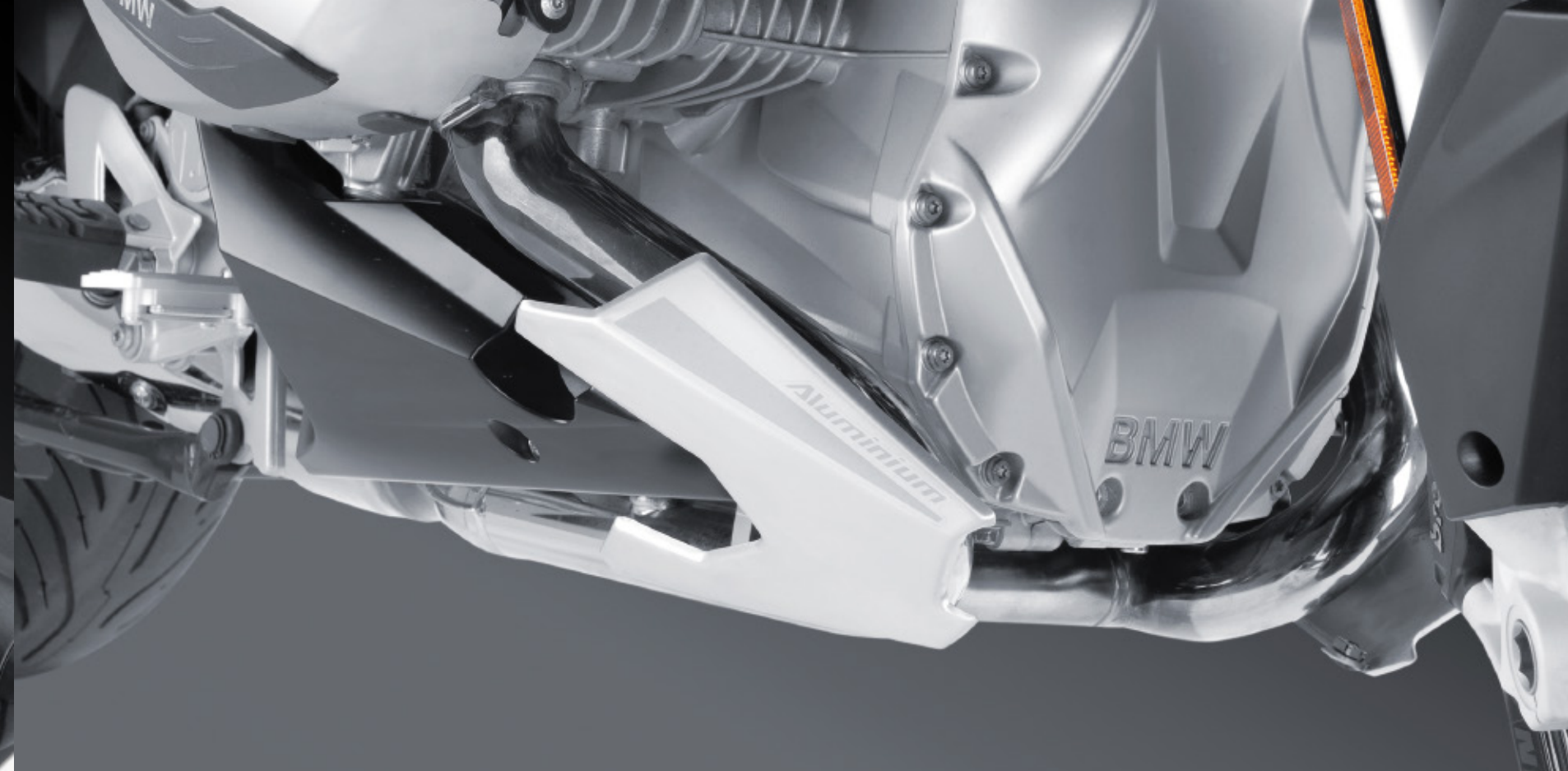

REAR HANDLES COVERS

HI-TECH PARTS | TECHNICAL SECTION

MODEL	YEAR	REF.	ⓘ
BMW			
R1200 R	15' - 18'	9083	(*)
R1200 RS	15' - 18'	9083	(*)
R1250 R	19' - 21'	9083	(*)
R1250 RS	19' - 21'	9083	(*)



REF. 9083J

■ J Matt black

(*) Check price with your distributor.
IMPORTANT: Indicate code color after part#. Example 0973A.

EXHAUST PROTECTOR - DEFLECTOR

HI-TECH PARTS | TECHNICAL SECTION

MODEL	YEAR	REF.	ⓘ
BMW			
R1200 RT	14' - 18'	8546	(*)



REF. 8546P

ALUMINIUM
BASE

FRONT DEFLECTOR

MODEL	YEAR	REF.	ⓘ
YAMAHA			
MT-09 TRACER	15' - 17'	8090	(*)



REF. 8090J

■ J Matt black

■ P Aluminium

(*) Check price with your distributor.
IMPORTANT: Indicate code color after part#. Example 0973A.

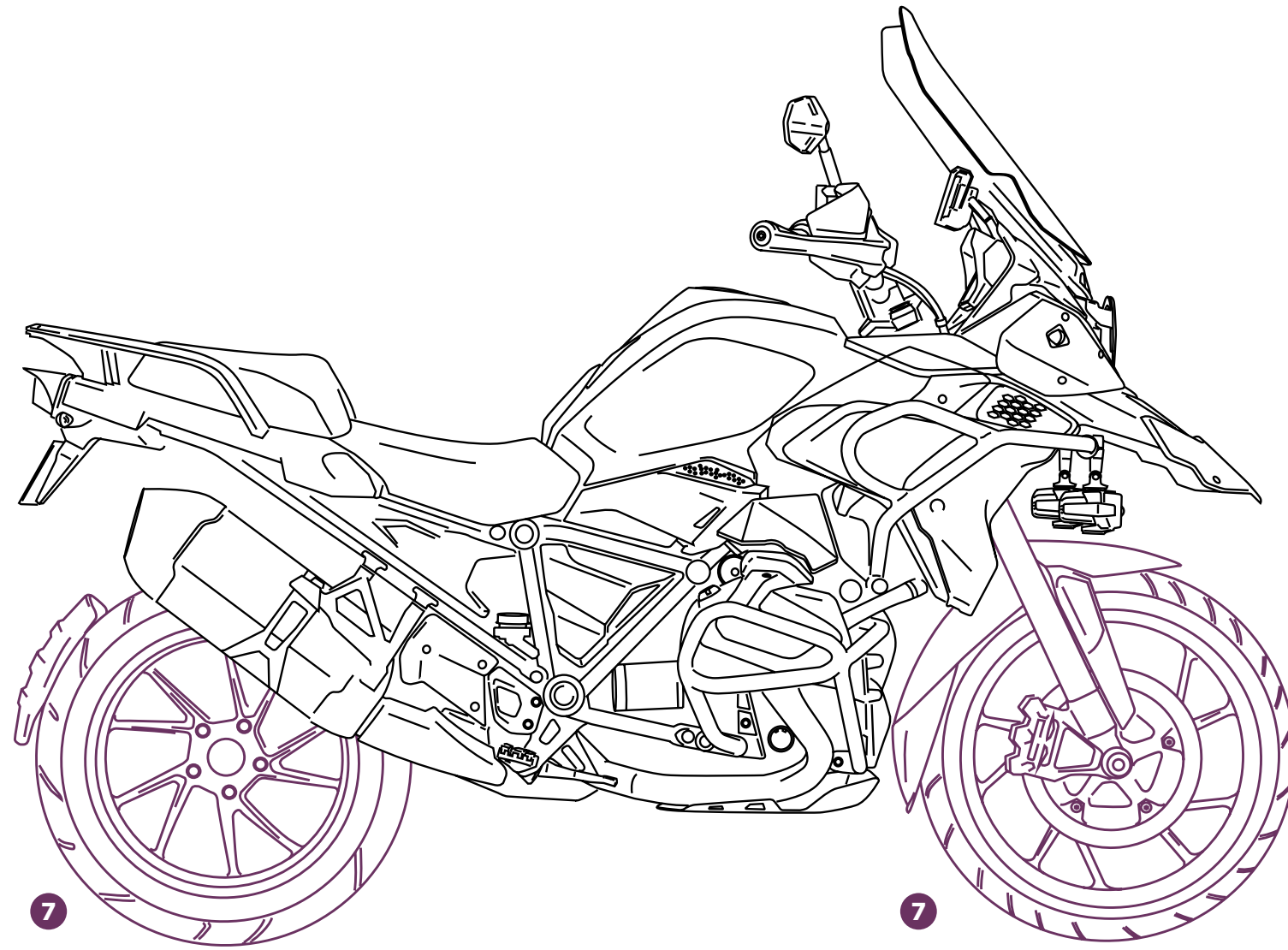

WHEELS AREA

ADHESIVE KIT FOR BMW CASES	597
ADHESIVE STRIPS	587
ADHESIVE STRIPS PREMIUM	589
ALUMINIUM FRONT FENDER	573
AXLE SLIDERS PHB19	583
FENDER EXTENSIONS	571
FRONT FENDER EXTENSION	575
REAR FENDER EXTENSION	565
REAR FENDERS	557
RIM STRIPS GS	594
SINGLE-SIDED REAR FENDER	569
SPECIAL RIM STRIPS	591
STAND SUPPORTS	602
SWING ARM PROTECTOR GS	595
TENSORS FOR REAR WHEEL BY PAIR	585
VALVES	584



REAR FENDERS

HI-TECH PARTS | TECHNICAL SECTION



Specific vanguard design for each bike, combined with the maximum protection against inclement weather.

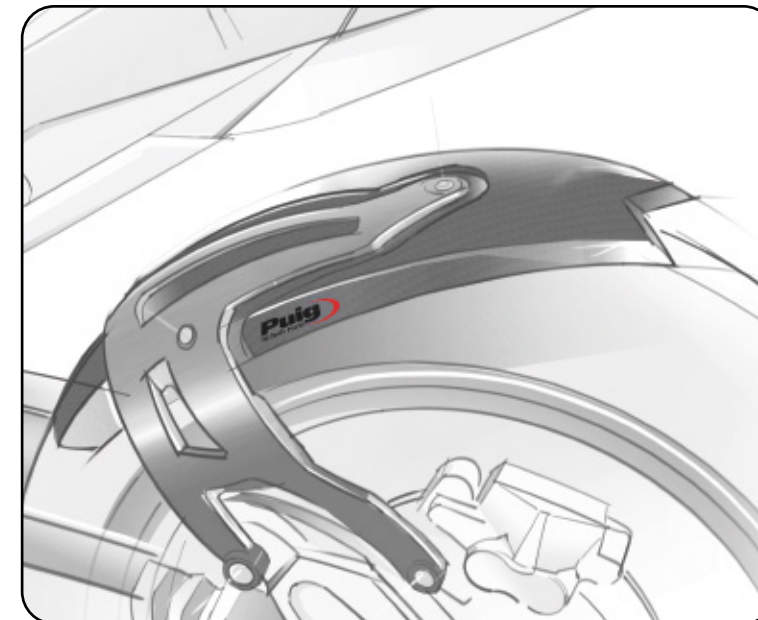

BMW R1200R 15'-18' (REF. 7682)

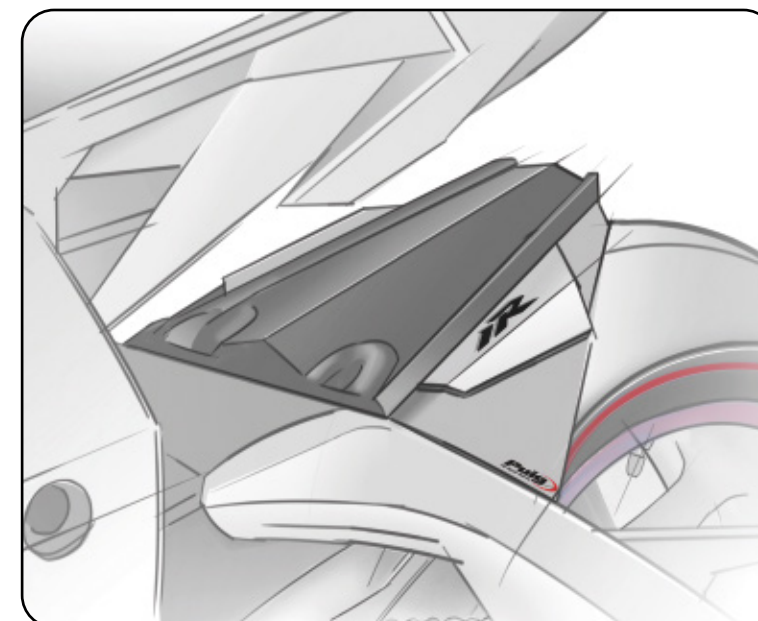

YAMAHA YZF-R1 15'-19' (REF. 7688)



FENDER S

Maximum protection with a specific vanguard design.



FENDER WITH ALUMINIUM SUPPORT

Support made of injected aluminium.



FENDER R

Racing look with stainless steel detail.



REAR FENDERS

HI-TECH PARTS | TYPE OF FENDER:

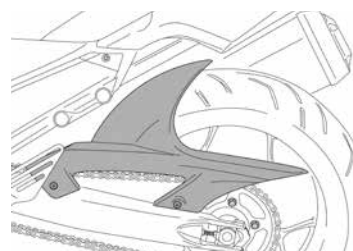

FENDER S

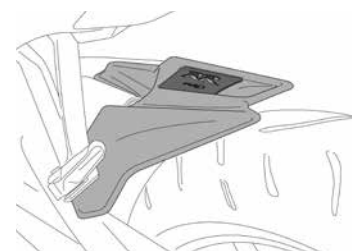

FENDER R

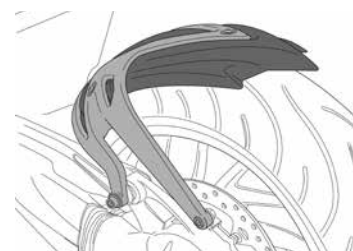

FENDER S WITH ALUMINIUM SUPPORT

2022		For the new 2022 motorcycle models check www.puig.tv				
MODEL	YEAR	TYPE OF FENDER	REFERENCE	J	C	
APRILIA						
SHIVER 750	07' - 16'	FENDER S	4902	(*)	(*)	
SHIVER 750 GT	08' - 16'	FENDER S	4902	(*)	(*)	
SHIVER 900	17' - 21'	FENDER S	4902	(*)	(*)	
BMW						
F650 GS	08' - 12'	FENDER S	5865	(*)	(*)	
F750GS	18' - 21'	FENDER S	20419	(*)	(*)	
F800 GS	08' - 17'	FENDER S	5865	(*)	(*)	
F800 GS ADVENTURE	13' - 17'	FENDER S	5865	(*)	(*)	
F800 GT	13' - 20'	FENDER S	6447	(*)	(*)	
F800 R	09' - 20'	FENDER S	5882	(*)	(*)	
F850GS	18' - 21'	FENDER S	20419	(*)	(*)	
F850GS ADVENTURE	19' - 21'	FENDER S	20419	(*)	(*)	
F900R	20' - 21'	FENDER S	20544	(*)	(*)	
F900XR	20' - 21'	FENDER S	20544	(*)	(*)	
G310 GS	17' - 20'	FENDER S	9949	(*)	(*)	
K1200 R	05' - 08'	FENDER WITH ALUMINIUM SUPPORT (NC) (#)	5887	(*)	(*)	
K1200 R SPORT	07' - 08'	FENDER WITH ALUMINIUM SUPPORT (NC) (#)	5887	(*)	(*)	
K1200 S	04' - 08'	FENDER WITH ALUMINIUM SUPPORT (NC) (#)	5887	(*)	(*)	
K1300 R	09' - 16'	FENDER WITH ALUMINIUM SUPPORT (NC) (#)	5887	(*)	(*)	
K1300 S	09' - 16'	FENDER WITH ALUMINIUM SUPPORT (NC) (#)	5887	(*)	(*)	
R1100 GS	94' - 99'	FENDER WITH ALUMINIUM SUPPORT (NC) (#)	5886	(*)	(*)	
R1150 GS	99' - 04'	FENDER WITH ALUMINIUM SUPPORT (NC) (#)	5886	(*)	(*)	
R1150 GS ADVENTURE	02' - 05'	FENDER WITH ALUMINIUM SUPPORT (NC) (#)	5886	(*)	(*)	
R1200 GS	04' - 12'	FENDER WITH ALUMINIUM SUPPORT (#)	5055	(*)	(*)	
R1200 GS	13' - 17'	FENDER WITH ALUMINIUM SUPPORT (#)	6352	(*)	(*)	
R1200 GS	18'	FENDER WITH ALUMINIUM SUPPORT (#)	1947	(*)	(*)	
R1200GS EXCLUSIVE	17'	FENDER WITH ALUMINIUM SUPPORT (#)	6352	(*)	(*)	
R1200GS RALLYE	17'	FENDER WITH ALUMINIUM SUPPORT (#)	6352	(*)	(*)	
R1200GS EXCLUSIVE	18'	FENDER WITH ALUMINIUM SUPPORT (#)	1947	(*)	(*)	

2022		For the new 2022 motorcycle models check www.puig.tv				
MODEL	YEAR	TYPE OF FENDER	REFERENCE	J	C	
R1200GS RALLYE	18'	FENDER WITH ALUMINIUM SUPPORT (#)	1947	(*)	(*)	
R1200 GS ADVENTURE	06' - 13'	FENDER WITH ALUMINIUM SUPPORT (#)	5055	(*)	(*)	
R1200GS ADVENTURE	14' - 17'	FENDER WITH ALUMINIUM SUPPORT (#)	6352	(*)	(*)	
R1200GS ADVENTURE	18'	FENDER WITH ALUMINIUM SUPPORT (#)	1947	(*)	(*)	
R1200 R	06' - 14'	FENDER WITH ALUMINIUM SUPPORT (#)	5861	(*)	(*)	
R1200 R	15' - 17'	FENDER WITH ALUMINIUM SUPPORT (#)	7682	(*)	(*)	
R1200 RS	15' - 17'	FENDER WITH ALUMINIUM SUPPORT (#)	7682	(*)	(*)	
R1200 RS	18'	FENDER WITH ALUMINIUM SUPPORT (#)	3503	(*)	(*)	
R1200 S	06' - 08'	FENDER WITH ALUMINIUM SUPPORT (#)	5861	(*)	(*)	
R1250GS	18' - 21'	FENDER WITH ALUMINIUM SUPPORT (#)	1947	(*)	(*)	
R1250GS HP	18' - 21'	FENDER WITH ALUMINIUM SUPPORT (#)	1947	(*)	(*)	
R1250GS ADVENTURE	18' - 21'	FENDER WITH ALUMINIUM SUPPORT (#)	1947	(*)	(*)	
R1250GS RALLYE	18' - 21'	FENDER WITH ALUMINIUM SUPPORT (#)	1947	(*)	(*)	
R1200 R	18'	FENDER WITH ALUMINIUM SUPPORT (#)	3503	(*)	(*)	
R1250 R	19' - 21'	FENDER WITH ALUMINIUM SUPPORT (#)	3503	(*)	(*)	
R1250 RS	19' - 21'	FENDER WITH ALUMINIUM SUPPORT (#)	3503	(*)	(*)	
R NINE T	14' - 20'	FENDER WITH ALUMINIUM SUPPORT (#)	7023	(*)	(*)	
R NINE T URBAN G/S	17' - 20'	FENDER WITH ALUMINIUM SUPPORT (#)	7023	(*)	(*)	
R NINE T PURE	17' - 20'	FENDER WITH ALUMINIUM SUPPORT (#)	7023	(*)	(*)	
R NINE T RACER	17' - 20'	FENDER WITH ALUMINIUM SUPPORT (#)	7023	(*)	(*)	
R NINE T SCRAMBLER	16' - 20'	FENDER WITH ALUMINIUM SUPPORT (#)	9464	(*)	(*)	
DUCATI						
SCRAMBLER CAFE RACER	17' - 21'	FENDER S	9165	(*)	(*)	
SCRAMBLER CLASSIC	15' - 21'	FENDER S	9165	(*)	(*)	
SCRAMBLER FLAT TRACK PRO	16'	FENDER S	9165	(*)	(*)	
SCRAMBLER FULL THROTTLE	15' - 21'	FENDER S	9165	(*)	(*)	
SCRAMBLER ICON	15' - 21'	FENDER S	9165	(*)	(*)	
SCRAMBLER 800 ICON DARK	20' - 21'	FENDER S	9165	(*)	(*)	
HARLEY DAVIDSON						
PAN AMERICA 1250	21'	FENDER S	20842	(*)	(*)	
HONDA						
CB500F	13' - 18'	FENDER S	6354	(*)	(*)	
CB500F	19' - 21'	FENDER S	3557	(*)	(*)	
CB500X	13' - 18'	FENDER S	6354	(*)	(*)	
CB500X	19' - 21'	FENDER S	3557	(*)	(*)	
CB600F HORNET	02' - 06'	FENDER S	1523	(*)	(*)	
CB600F HORNET	07' - 15'	FENDER S	4403	(*)	(*)	
CB600F HORNET ABS	08'	FENDER S	4403	(*)	(*)	

NOTE: PREVIOUSLY VERIFY ANY INTERFERENCE BETWEEN OUR PRODUCT AND ANY OTHER ACCESSORY (OEM OR AFTERMARKET) ALREADY INSTALLED ON THE MOTORCYCLE.

(D) Aluminium chainguard included.

(NC) Keep original chainguard.

(#) Rear hugger not compatible with OFF-ROAD tires.

(*) Check price with your distributor.

IMPORTANT: Indicate code color after part#. Example 0973A.

J Matt black

C Carbon look

REAR FENDERS

HI-TECH PARTS | TYPE OF FENDER:

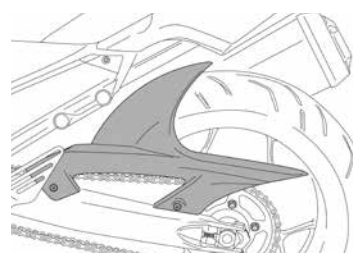

FENDER S

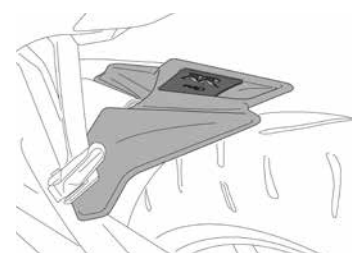

FENDER R



FENDER S WITH ALUMINIUM SUPPORT

2022		For the new 2022 motorcycle models check www.puig.tv			
MODEL	YEAR	TYPE OF FENDER	REFERENCE	J	C
CB1000R	08' - 16'	FENDER S (NC)	4692	(*)	(*)
CB1000RA	08' - 16'	FENDER S (NC)	4692	(*)	(*)
CB1300	02' - 10'	FENDER S (D)	1638	(*)	(*)
CBF500	04' - 07'	FENDER S	4127	(*)	(*)
CBF600	04' - 07'	FENDER S	4127	(*)	(*)
CBF600	08' - 14'	FENDER S	4691	(*)	(*)
CBF600 ABS	04' - 07'	FENDER S	4127	(*)	(*)
CBF600 ABS	08' - 14'	FENDER S	4691	(*)	(*)
CBF600S	04' - 07'	FENDER S	4127	(*)	(*)
CBF600S	08' - 14'	FENDER S	4691	(*)	(*)
CBF600S ABS	04' - 07'	FENDER S	4127	(*)	(*)
CBF600S ABS	08' - 14'	FENDER S	4691	(*)	(*)
CBF1000	06' - 09'	FENDER S	4127	(*)	(*)
CBF1000	10' - 11'	FENDER S	4691	(*)	(*)
CBF1000 ABS	10' - 11'	FENDER S	4691	(*)	(*)
CBF1000F	10' - 16'	FENDER S	4691	(*)	(*)
CBF1000F ABS	10' - 16'	FENDER S	4691	(*)	(*)
CBR500R	13' - 18'	FENDER S	6354	(*)	(*)
CBR500R	19' - 21'	FENDER S	3557	(*)	(*)
CBR600F	99' - 07'	FENDER S	1436	(*)	(*)
CBR600F	11' - 13'	FENDER S	4403	(*)	(*)
CBR1000RR FIREBLADE/SP	20' - 21'	FENDER R	20488	(*)	(*)
CBR1100XX	97' - 07'	FENDER S	1445	(*)	(*)
CRF1000L AFRICA TWIN	16' - 19'	FENDER S	3484	(*)	(*)
CRF1000L AFRICA TWIN ADVENTURE SPORTS	18' - 19'	FENDER S	3484	(*)	(*)
CRF1100L AFRICA TWIN	20' - 21'	FENDER S	3825	(*)	(*)
CRF1100L AFRICA TWIN ADVENTURE SPORTS	20' - 21'	FENDER S	3825	(*)	(*)
CROSSTOURER	12' - 18'	FENDER S	6334	(*)	(*)
CROSSTOURER DCT	12' - 18'	FENDER S	6334	(*)	(*)
FORZA 750	21'	FENDER S	20575	(*)	(*)

2022		For the new 2022 motorcycle models check www.puig.tv			
MODEL	YEAR	TYPE OF FENDER	REFERENCE	J	C
INTEGRA 700	12' - 13'	FENDER S	6038	(*)	(*)
INTEGRA 750	14' - 21'	FENDER S	7047	(*)	(*)
INTEGRA 750S	14' - 16'	FENDER S	7047	(*)	(*)
NC700S/X	12' - 13'	FENDER S	6038	(*)	(*)
NC750S/X	14' - 21'	FENDER S	6038	(*)	(*)
VFR1200F	10' - 16'	FENDER S	5276	(*)	(*)
X-ADV	21'	FENDER S	20575	(*)	(*)
KAWASAKI					
ER-6N	05' - 08'	FENDER S	4092	(*)	(*)
ER-6N	12' - 16'	FENDER S	6041	(*)	(*)
ER-6F	06' - 08'	FENDER S	4092	(*)	(*)
ER-6F	12' - 16'	FENDER S	6041	(*)	(*)
NINJA 300	13' - 17'	FENDER S	6843	(*)	(*)
VERSYS 650	07' - 21'	FENDER S (NC)	4407	(*)	(*)
Z300	15' - 17'	FENDER S	6843	(*)	(*)
Z750	07' - 12'	FENDER S	4524	(*)	(*)
Z750R	11' - 12'	FENDER S	4431	(*)	(*)
Z750S	05' - 06'	FENDER S	4524	(*)	(*)
Z800	13' - 16'	FENDER S	6462	(*)	(*)
Z800E	13' - 16'	FENDER S	6462	(*)	(*)
Z1000	07' - 09'	FENDER S	4431	(*)	(*)
ZZR1400	12' - 21'	FENDER S	6043	(*)	(*)
KTM					
1090 ADVENTURE/R	17' - 20'	FENDER S	3670	(*)	(*)
1190 ADVENTURE/R	13' - 16'	FENDER S	3670	(*)	(*)
1290 SUPER ADVENTURE	15' - 16'	FENDER S	3670	(*)	(*)
1290 SUPER ADVENTURE R/S	17' - 20'	FENDER S	3670	(*)	(*)
1290 SUPER ADVENTURE R	21'	FENDER S	20649	(*)	(*)
1290 SUPER ADVENTURE T	17'	FENDER S	3670	(*)	(*)
SUZUKI					
DL650 V-STROM ABS	07' - 11'	FENDER S	4710	(*)	(*)
DL650 V-STROM	12' - 21'	FENDER S	4710	(*)	(*)
DL650XT V-STROM	15' - 21'	FENDER S	4710	(*)	(*)
DL1000 V-STROM	14' - 19'	FENDER S	6477	(*)	(*)
DL1000XT V-STROM	17' - 19'	FENDER S	6477	(*)	(*)
DL1050 V-STROM	20' - 21'	FENDER S	6477	(*)	(*)
D 1050XT V-STROM	20' - 21'	FENDER S	6477	(*)	(*)
GSF1250 BANDIT	07' - 13'	FENDER S	4409	(*)	(*)

NOTE: PREVIOUSLY VERIFY ANY INTERFERENCE BETWEEN OUR PRODUCT AND ANY OTHER ACCESSORY (OEM OR AFTERMARKET) ALREADY INSTALLED ON THE MOTORCYCLE.

(D) Aluminium chainguard included.

(NC) Keep original chainguard.

(#) Rear hugger not compatible with OFF-ROAD tires.

(*) Check price with your distributor.

IMPORTANT: Indicate code color after part#. Example 0973A.

J Matt black

C Carbon look

REAR FENDERS

HI-TECH PARTS | TYPE OF FENDER:

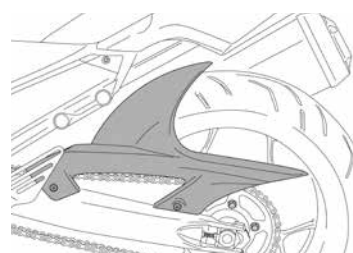

FENDER S

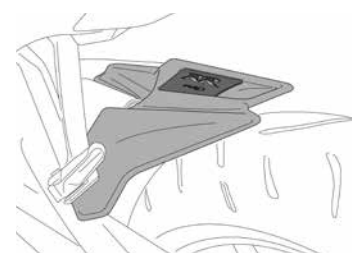



FENDER R



FENDER S WITH ALUMINIUM SUPPORT

2022		For the new 2022 motorcycle models check www.puig.tv				
MODEL	YEAR	TYPE OF FENDER	REFERENCE	J	C	
GSF1250S BANDIT	07' - 13'	FENDER S	4409	(*)	(*)	
GSF1250S BANDIT ABS	07' - 13'	FENDER S	4409	(*)	(*)	
GSX1250F/FA	10' - 17'	FENDER S	4409	(*)	(*)	
GSX1250F/FA ABS	10' - 17'	FENDER S	4409	(*)	(*)	
GSX1400	01' - 06'	FENDER S (D)	1471	(*)	(*)	
GSX-R1000	09' - 16'	FENDER R	5059	(*)		
GSX-R1000/R	17' - 20'	FENDER R	8999	(*)	(*)	
GSX-R1300 HAYABUSA	08' - 17'	FENDER S	4693	(*)		
SFV650 GLADIUS	09' - 15'	FENDER S	5019	(*)	(*)	
SV650	16' - 21'	FENDER S	5019	(*)	(*)	
SV650X	18' - 21'	FENDER S	5019	(*)	(*)	
TRIUMPH						
TIGER 800/XC	11' - 14'	FENDER S	6040	(*)	(*)	
TIGER 800 XC/XCX/XCA	15' - 20'	FENDER S	6040	(*)	(*)	
TIGER 800 XR/XRX/XRT	15' - 20'	FENDER S	6040	(*)	(*)	
TIGER 900	20' - 21'	FENDER S	20379	(*)	(*)	
TIGER 900 GT	20' - 21'	FENDER S	20379	(*)	(*)	
TIGER 900 GT LOW	20' - 21'	FENDER S	20379	(*)	(*)	
TIGER 900 GT PRO	20' - 21'	FENDER S	20379	(*)	(*)	
TIGER 900 RALLY	20' - 21'	FENDER S	20379	(*)	(*)	
TIGER 900 RALLY PRO	20' - 21'	FENDER S	20379	(*)	(*)	
TIGER EXPLORER	12' - 15'	FENDER WITH ALUMINIUM SUPPORT	6465	(*)	(*)	
TIGER EXPLORER XC	13' - 15'	FENDER WITH ALUMINIUM SUPPORT	6465	(*)	(*)	
TIGER EXPLORER XC/XR/XRX/XRT/XCX/XCA	16' - 20'	FENDER WITH ALUMINIUM SUPPORT	8595	(*)	(*)	
TIGER 1200 ALPINE	21'	FENDER WITH ALUMINIUM SUPPORT	8595	(*)	(*)	
TIGER 1200 DESERT	21'	FENDER WITH ALUMINIUM SUPPORT	8595	(*)	(*)	
YAMAHA						
MT-03	16' - 21'	FENDER S	8558	(*)	(*)	
MT-07	14' - 21'	FENDER S	7048	(*)	(*)	
MT-07 TRACER	16' - 19'	FENDER S	9205	(*)	(*)	

2022		For the new 2022 motorcycle models check www.puig.tv				
MODEL	YEAR	TYPE OF FENDER	REFERENCE	J	C	
MT-07 TRACER	20' - 21'	FENDER S	9205	(*)	(*)	
MT-07 TRACER GT	19' - 21'	FENDER S	9205	(*)	(*)	
MT-09 TRACER/GT	21'	FENDER S	3866	(*)	(*)	
TENERE 700	19' - 21'	FENDER S	3730	(*)	(*)	
XJ6/DIVERSION	09' - 16'	FENDER S	5035	(*)	(*)	
XJ6 DIVERSION F	10' - 16'	FENDER S	5035	(*)	(*)	
XJR1200	94' - 98'	FENDER S (D)	1477	(*)	(*)	
XJR1300	99' - 13'	FENDER S (D)	1477	(*)	(*)	
XSR700	16' - 21'	FENDER S	7048	(*)	(*)	
XSR700 XTRIBUTE	19' - 21'	FENDER S	7048	(*)	(*)	
XT1200Z SUPER TENERÉ	10' - 21'	FENDER S	3567	(*)	(*)	
XT1200ZE SUPER TENERE	19' - 21'	FENDER S	3567	(*)	(*)	
YZF-R1	15' - 21'	FENDER R	7688	(*)	(*)	
YZF-R1M	17' - 21'	FENDER R	7688	(*)	(*)	
YZF-R3	15' - 21'	FENDER S	8558	(*)	(*)	

-  J Matt black
-  C Carbon look

NOTE: PREVIOUSLY VERIFY ANY INTERFERENCE BETWEEN OUR PRODUCT AND ANY OTHER ACCESSORY (OEM OR AFTERMARKET) ALREADY INSTALLED ON THE MOTORCYCLE.

- (D) Aluminium chainguard included.
- (NC) Keep original chainguard.
- (#) Rear hugger not compatible with OFF-ROAD tires.
- (*) Check price with your distributor.

IMPORTANT: Indicate code color after part#. Example 0973A.



REAR FENDER EXTENSION

HI-TECH PARTS | TECHNICAL SECTION



FUNCTIONAL

It improves the protection of the original fender.



MATERIAL

Manufactured in ABS material. It attaches through adhesive and mechanical processes and plastic rivets.



REF. 9911J

 J Matt black

FOR SPECIFIC MODELS SEE PAGE 566.

REAR FENDER EXTENSION

HI-TECH PARTS

2022 For the new 2022 motorcycle models check www.puig.tv			
MODEL	YEAR	REF.	J
BENELLI			
LEONCINO 500	15' - 21'	9905	(*)
LEONCINO TRAIL	15' - 21'	9905	(*)
BMW			
F900 R	20' - 21'	20302	(*)
F900 XR	20' - 21'	20302	(*)
S1000 R	09' - 20'	9885	(*)
S1000RR	09' - 18'	9885	(*)
S1000RR	19' - 21'	3726	(*)
S1000 XR	15' - 19'	3665	(*)
S1000 XR	20' - 21'	20478	(*)
DUCATI			
MONSTER 821	14' - 20'	9886	(*)
SUPERSPORT 939/S	17' - 21'	9887	(*)
HONDA			
CB125R NEO SPORTS CAFÉ	18' - 21'	3514	(*)
CB300R NEO SPORTS CAFÉ	18' - 21'	3514	(*)
CB650R NEO SPORTS CAFÉ	19' - 21'	3725	(*)
CB1000R NEO SPORTS CAFE	18' - 21'	1803	(*)
CB1000R BLACK EDITION	21'	1803	(*)
CBR600RR	08' - 12'	9888	(*)
CBR650R	19' - 21'	3725	(*)
CBR1000RR FIREBLADE	08' - 11'	9889	(*)
CBR1000RR FIREBLADE	13' - 19'	9891	(*)
HUSQVARNA			
SVARTPILEN 401	18' - 21'	3676	(*)
VITPILEN 401	18' - 21'	3676	(*)
KAWASAKI			
ER-6N	09' - 11'	9892	(*)
ER-6F	09' - 11'	9892	(*)
NINJA 250R	13'	9896	(*)
NINJA 300	13' - 21'	9896	(*)

2022 For the new 2022 motorcycle models check www.puig.tv			
MODEL	YEAR	REF.	J
NINJA 650	17' - 21'	9790	(*)
NINJA 1000 SX	20' - 21'	9894	(*)
VERSYS-X 300	17' - 21'	9895	(*)
VERSYS 1000	12' - 18'	3515	(*)
VERSYS 1000	19' - 21'	3677	(*)
Z250	13' - 16'	9896	(*)
Z300	13' - 21'	9896	(*)
Z400	17' - 21'	1811	(*)
Z650	17' - 21'	9790	(*)
Z800E	12' - 16'	9897	(*)
Z800	12' - 16'	9897	(*)
Z900	17' - 21'	0022	(*)
Z900RS	18' - 21'	0022	(*)
Z900RS CAFE	18' - 19'	0022	(*)
Z1000	10' - 16'	9893	(*)
Z1000SX	10' - 16'	9893	(*)
Z1000/SX	17' - 21'	9894	(*)
ZX-10R	17' - 21'	1939	(*)
KTM			
125 DUKE	12' - 16'	9899	(*)
125 DUKE	17' - 21'	1882	(*)
200 DUKE	12' - 16'	9899	(*)
390 DUKE	12' - 16'	9899	(*)
390 DUKE	17' - 21'	1882	(*)
690 DUKE	12' - 21'	9900	(*)
690 DUKE R	12' - 21'	9900	(*)
790 DUKE	18' - 21'	0024	(*)
1290 SUPERDUKE R	14' - 19'	9898	(*)
1290 SUPERDUKE R	20' - 21'	20479	(*)
1290 SUPERDUKE GT	16' - 21'	9898	(*)
SUZUKI			
GSR750	11' - 16'	9902	(*)

2022 For the new 2022 motorcycle models check www.puig.tv			
MODEL	YEAR	REF.	J
GSX-R600	06' - 07'	9903	(*)
GSX-R750	06' - 07'	9903	(*)
GSX-S750	17' - 21'	9901	(*)
GSX-S1000	15' - 21'	9904	(*)
GSX-S1000F	15' - 21'	9904	(*)
TRIUMPH			
STREET TRIPLE	17' - 19'	9906	(*)
STREET TRIPLE R	17' - 21'	9906	(*)
STREET TRIPLE S	17' - 21'	9906	(*)
STREET TRIPLE RS	17' - 21'	9906	(*)
TIGER 1050	07' - 11'	9907	(*)
TIGER SPORT	13' - 21'	9908	(*)
YAMAHA			
FZ1	06' - 14'	9909	(*)
FZ1 FAZER	06' - 14'	9909	(*)
FZ8	10' - 15'	9909	(*)
FZ8 FAZER	10' - 15'	9909	(*)
FAZER8	10' - 15'	9909	(*)
MT-07	13' - 17'	9911	(*)
MT-07	18' - 21'	9912	(*)
MT-07 TRACER	16' - 21'	9912	(*)
MT-07 TRACER GT	20' - 21'	9912	(*)
MT-09	13' - 20'	9910	(*)
MT-09 SP	18' - 20'	9910	(*)
MT-09 TRACER	15' - 17'	9910	(*)
MT-09 TRACER	18' - 20'	0016	(*)
MT-09 TRACER GT	18' - 20'	0016	(*)
MT-10	16' - 21'	3508	(*)
XSR700	16' - 21'	9911	(*)
XSR 900	16' - 21'	9910	(*)
YZF-R1	15' - 21'	9913	(*)
YZF-R6	05' - 20'	9914	(*)

NOTE: MANUFACTURED IN ABS MATERIAL.
IT ATTACHES THROUGH ADHESIVE AND MECHANICAL PROCESSES AND PLASTIC RIVETS.
ONLY SUITABLE FOR OEM FENDER.

(*) Check price with your distributor.

IMPORTANT: Indicate code color after part#. Example 0973A.

J Matt black

NOTE: MANUFACTURED IN ABS MATERIAL.
IT ATTACHES THROUGH ADHESIVE AND MECHANICAL PROCESSES AND PLASTIC RIVETS.
ONLY SUITABLE FOR OEM FENDER.

(*) Check price with your distributor.

IMPORTANT: Indicate code color after part#. Example 0973A.

J Matt black



SINGLE-SIDED REAR FENDER

HI-TECH PARTS | TECHNICAL SECTION



FUNCTIONAL
Protects the motorcycle and the rider from water, mud and small rocks.

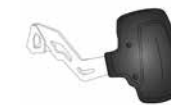

MATERIAL
Fender made of ABS.



MATERIAL
Manufactured from machined aluminium with chamfered edge.



ADJUSTABLE
Dimmable and adjustable.





WEIGHT
Light and resistant.
Manufactured in aluminium.



REF. 20397J

2022	For the new 2022 motorcycle models check www.puig.tv			
MODEL	YEAR	REF.	J	C
HONDA				
CRF1100L AFRICA TWIN	20' - 21'	20397	(*)	(*)
CRF1100L AFRICA TWIN ADVENTURE SPORTS	20' - 21'	20397	(*)	(*)
BMW				
F750GS	18' - 21'	3691	(*)	(*)
F850GS	18' - 21'	3691	(*)	(*)
F850GS ADVENTURE	19' - 21'	3691	(*)	(*)

-  J Matt black
-  C Carbon look

(*) Check price with your distributor.
IMPORTANT: Indicate code color after part#. Example 0973A.



FENDER EXTENSIONS

HI-TECH PARTS | TECHNICAL SECTION

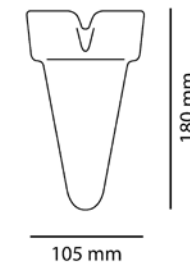

URBAN UNIVERSAL

MODEL	REF.	N
URBAN UNIVERSAL	6413	(*)

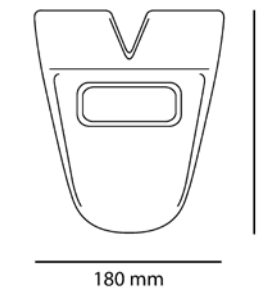

TOUR UNIVERSAL

MODEL	REF.	N
TOUR UNIVERSAL	6412	(*)

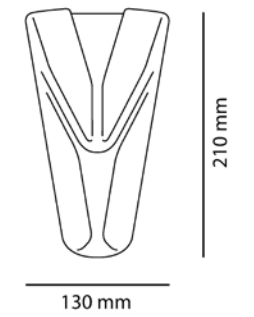

URBAN HONDA

MODEL	REF.	N
URBAN HONDA NC700X/S - INTEGRA	6428	(*)

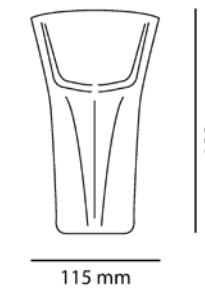

TOUR YAMAHA

MODEL	REF.	N
TOUR YAMAHA FZ1/FZ8	6427	(*)

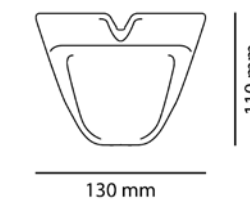

SPORT UNIVERSAL

MODEL	REF.	N
SPORT UNIVERSAL	6414	(*)

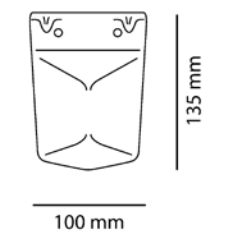

TOUR DUCATI

MODEL	REF.	N
TOUR DUCATI	6675	(*)

 N Black

NOTE: MANUFACTURED IN ABS PLASTIC. IT IS SUPPLIED WITH 3M STICKER TO N-BLACK FIX IT TO THE HUGGER.

(*) Check price with your distributor.
IMPORTANT: Indicate code color after part#. Example 0973A.



ALUMINIUM FRONT FENDER

HI-TECH PARTS | TECHNICAL SECTION



REF. 9992N



REF. 3688N

2022		For the new 2022 motorcycle models check www.puig.tv			
MODEL	YEAR	MATERIAL	REF.	N	
HARLEY DAVIDSON					
SPORTSTER 883 IRON	09' - 20'	MILLED ALUMINUM	9992	(*)	
SPORTSTER 883 IRON	09' - 20'	MILLED SHEET	3688	(*)	
HONDA					
CMX 300 REBEL	17' - 20'	MILLED SHEET	3525	(*)	
CMX 500 REBEL	17' - 21'	MILLED SHEET	3525	(*)	
CMX 500 REBEL S	20' - 21'	MILLED SHEET	3525	(*)	
INDIAN					
SCOUT	15' - 21'	MILLED ALUMINUM	9739	(*)	
SCOUT BOBBER	18' - 21'	MILLED ALUMINUM	20296	(*)	
KAWASAKI					
VULCAN S	15' - 21'	MILLED ALUMINUM	9673	(*)	
VULCAN S	15' - 21'	MILLED SHEET	3817	(*)	
VULCAN S CAFE	17' - 20'	MILLED ALUMINUM	9673	(*)	
VULCAN S CAFE	17' - 20'	MILLED SHEET	3817	(*)	
UNIVERSAL					
METALLIC SHEET FRONT FENDER			3735N	(*)	

 N Black

NOTE: FITTING KIT IN STEEL.

(*) Check price with your distributor.

IMPORTANT: Indicate code color after part#. Example 0973A.

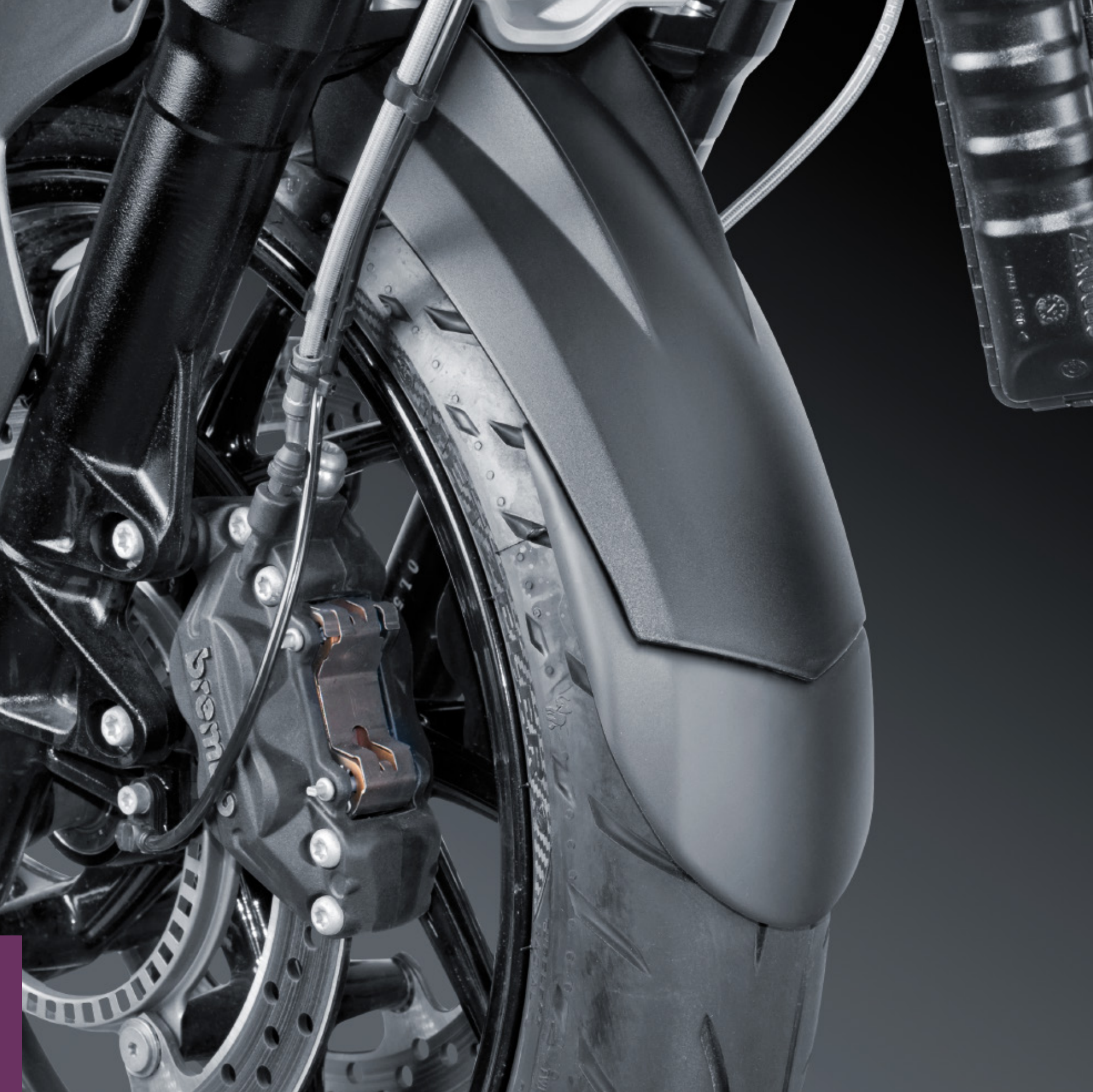

FRONT FENDER EXTENSION

HI-TECH PARTS | TECHNICAL SECTION

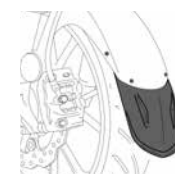

FUNCTIONAL

It improves the protection of the original fender.



MATERIAL

Manufactured in ABS material. It attaches through adhesive and mechanical processes and plastic rivets.



REF. 5786N

 N Black

FOR SPECIFIC MODELS SEE PAGE 576.

FRONT FENDER EXTENSION

HI-TECH PARTS

2022	For the new 2022 motorcycle models check www.puig.tv			
MODEL	YEAR	REF.	N	
APRILIA				
CAPONORD 1200	13' - 17'	20472	(*)	
CAPONORD 1200 RALLY	15' - 17'	9284	(*)	
MANA 850	07' - 11'	9940	(*)	
RSV4 R	11' - 14'	20472	(*)	
RSV4 RF	15' - 21'	20472	(*)	
RSV4 RR	15' - 21'	20472	(*)	
SHIVER 750	08' - 21'	5798	(*)	
SHIVER 900	17' - 21'	20472	(*)	
BENELLI				
LEONCINO 500	15' - 21'	3516	(*)	
LEONCINO TRAIL	15' - 21'	3516	(*)	
TRK 502/X	16' - 21'	20806	(*)	
BMW				
F650 GS	08' - 12'	5783	(*)	
F650 GS	02' - 07'	6177	(*)	
F700 GS	12' - 17'	6821	(*)	
F750 GS	18' - 21'	1941	(*)	
F800 GS	08' - 18'	5785	(*)	
F800 R	09' - 14'	5786	(*)	
F800 S	06' - 10'	5786	(*)	
F800 ST	06' - 13'	5786	(*)	
F800 R	15' - 19'	9020	(*)	
F800 GT	13' - 21'	5786	(*)	
F850 GS	18' - 21'	1942	(*)	
F850 GS ADVENTURE	18' - 21'	1942	(*)	
F900 R	20' - 21'	8084	(*)	
F900 XR	20' - 21'	20303	(*)	
G310GS	17' - 21'	9916	(*)	
G310R	17' - 21'	9812	(*)	
G650 GS	09' - 16'	6177	(*)	
K1200 S	04' - 08'	6172	(*)	
K1200R	05' - 08'	9814	(*)	
K1200GT	06' - 08'	6168	(*)	
K1300 S	08' - 16'	6172	(*)	

2022	For the new 2022 motorcycle models check www.puig.tv			
MODEL	YEAR	REF.	N	
K1300R	09' - 15'	9814	(*)	
K1300GT	09' - 11'	6168	(*)	
K1600 GT	11' - 21'	6168	(*)	
K1600 GTL	11' - 21'	6168	(*)	
R850R	00'-07'	9813	(*)	
R850R	94' - 99'	6429	(*)	
R850C/GS	95' - 07'	6167	(*)	
R1100 GS	94' - 99'	9813	(*)	
R1100 RT	96' - 01'	6167	(*)	
R1100 R	94' - 00'	6429	(*)	
R1100S	99' - 05'	6430	(*)	
R1100 GS	94' - 99'	9813	(*)	
R1150 GS	99' - 05'	6164	(*)	
R1150 RT	01' - 05'	6167	(*)	
R1200 C	97' - 05'	6431	(*)	
R1200 GS/ ADVENTURE	04' - 12'	5784	(*)	
R1200 GS	13' - 18'	6822	(*)	
R1200 GS	13' - 18'	9202 (+)	(*)	
R1200 GS ADVENTURE	13' - 18'	6822	(*)	
R1200 GS ADVENTURE	13' - 18'	9202 (+)	(*)	
R1200GS EXCLUSIVE	13' - 21'	9202 (+)	(*)	
R1200GS RALLYE	13' - 21'	9202 (+)	(*)	
R1200 R	05' - 10'	5661	(*)	
R1200 R	11' - 14'	9021	(*)	
R1200 R	15' - 21'	9022	(*)	
R1200 RS	15' - 18'	9203 (*)	(*)	
R1200 RT	05' - 13'	6160	(*)	
R1200 RT	14' - 18'	8487	(*)	
R1250 R	19' - 21'	9022	(*)	
R1250GS	19' - 21'	6822	(*)	
R1250GS	19' - 21'	9202 (+)	(*)	
R1250GS ADVENTURE	19' - 21'	6822	(*)	
R1250GS ADVENTURE	19' - 21'	9202 (+)	(*)	
R1250 RT	19' - 20'	20358	(*)	
R1250 RS	19' - 21'	9203	(*)	

NOTE: MANUFACTURED IN ABS MATERIAL.
IT ATTACHES THROUGH ADHESIVE AND MECHANICAL PROCESSES AND PLASTIC RIVETS.

(*) Fixation with glue.
(+) Bigger extension. Check image on the our site.
(*) Check price with your distributor.

IMPORTANT: Indicate code color after part#. Example 0973A.

 N Black

2022	For the new 2022 motorcycle models check www.puig.tv			
MODEL	YEAR	REF.	N	
R NINE T	14' - 21'	8186	(*)	
R NINE T RACER	14' - 21'	8186	(*)	
R NINE T SCRAMBLER	14' - 21'	8186	(*)	
R NINE T SCRAMBLER	16' - 21'	9815	(*)	
R NINE T URBAN G/S	17' - 21'	3895	(*)	
S1000 R	14' - 20'	8084	(*)	
S1000RR	10' - 18'	8084	(*)	
S1000RR	19' - 21'	3896	(*)	
S1000 XR	15' - 19'	8084	(*)	
S1000 XR	20' - 21'	20525	(*)	
DUCATI				
DIAVEL	11' - 15'	6178	(*)	
MONSTER 696	08' - 12'	6415	(*)	
MONSTER 796	10' - 13'	6415	(*)	
MONSTER 1100/S	09' - 13'	6415	(*)	
MONSTER 1100 EVO	09' - 13'	6415	(*)	
MONSTER 1200/S	14' - 21'	3897	(*)	
MULTISTRADA 1200/S	10' - 15'	6416	(*)	
MULTISTRADA 1200 ENDURO	16' - 21'	9816	(*)	
MULTISTRADA 950	17' - 21'	9816	(*)	
SCRAMBLER ICON	14' - 21'	9023	(*)	
SCRAMBLER SIXTY2	14' - 21'	9023	(*)	
MULTISTRADA V4	21'	20807	(*)	
MULTISTRADA V4 S	21'	20807	(*)	
MULTISTRADA V4 S SPORT	21'	20807	(*)	
HARLEY DAVIDSON				
XL/FXDB/FXDL/FXDS/FXD/FXDX/FXDXT/FXDC				
/FXDWG/XLH/FXSTD/FXST/FXDXT/FXSTC		6170	(*)	
XR 1200	08' - 21'	6175	(*)	
XR 1200X	08' - 21'	6175	(*)	
X-R/V-ROD	08' - 10'	6175	(*)	
HONDA				
CMX 500 REBEL	17' - 21'	9819	(*)	
CMX 500 REBEL S	20' - 21'	9819	(*)	
CB125R NEO SPORTS CAFE	18' - 21'	3678	(*)	

NOTE: MANUFACTURED IN ABS MATERIAL.
IT ATTACHES THROUGH ADHESIVE AND MECHANICAL PROCESSES AND PLASTIC RIVETS.

(*) Fixation with glue.
(+) Bigger extension. Check image on the our site.
(*) Check price with your distributor.

IMPORTANT: Indicate code color after part#. Example 0973A.

 N Black

FRONT FENDER EXTENSION

HI-TECH PARTS

2022 For the new 2022 motorcycle models check www.puig.tv				
MODEL	YEAR	REF.	N	
CROSSRUNNER	15' - 21'	8163	(*)	
CROSSTOURER DCT	12' - 21'	6417	(*)	
CTX1300 DX	14' - 21'	9823	(*)	
GL1800 GOLD WING	18' - 21'	3900	(*)	
INTEGRA 700	12' - 13'	6302	(*)	
INTEGRA 750	14' - 16'	6302	(*)	
MSX125	13' - 15'	9817	(*)	
MSX125	16' - 20'	9818	(*)	
NC700X/S	12' - 14'	6418	(*)	
NC750X/S	12' - 14'	6418	(*)	
NT650V DEAUVILLE	98' - 06'	5801	(*)	
NT700V DEAUVILLE	06' - 11'	5801	(*)	
NM4 VULTUS	14' - 21'	9823	(*)	
ST1300 PAN-EUROPEAN	02' - 16'	5805	(*)	
VFR750F	91' - 97'	5801	(*)	
VFR800	02' - 13'	5803	(*)	
VFR800F	14' - 21'	8163	(*)	
VFR1200F	10' - 17'	5804	(*)	
VTR1000 SP-1	00' - 01'	9919	(*)	
VTR1000 SP-2	02' - 06'	9919	(*)	
XL650V TRANSALP	01' - 07'	9920	(*)	
XL700V TRANSALP	08' - 13'	5802	(*)	
XL1000V VARADERO	98' - 13'	5799	(*)	
X-ADV	17' - 21'	9824	(*)	
HUSQVARNA				
SVARTPILEN 401	18' - 21'	3681	(*)	
VITPILEN 401	18' - 21'	3681	(*)	
VITPILEN 701	18' - 21'	3684	(*)	
INDIAN SCOUT				
SCOUT	15' - 21'	9825 (*)	(*)	
KAWASAKI				
ER-6F/N	09' - 11'	6419	(*)	
ER-6F/N	12' - 15'	6420	(*)	
GTR1400	06' - 21'	6163	(*)	
NINJA 250R	08' - 14'	9921	(*)	

2022 For the new 2022 motorcycle models check www.puig.tv				
MODEL	YEAR	REF.	N	
NINJA H2 SX	18' - 21'	9865	(*)	
NINJA 300	13' - 21'	3517	(*)	
NINJA 400	17' - 21'	1940	(*)	
NINJA 650	17' - 21'	9827	(*)	
NINJA 1000 SX	20' - 21'	20473	(*)	
VERSYS X-300	17' - 21'	9922	(*)	
VERSYS 650	06' - 09'	5778	(*)	
VERSYS 650	10' - 21'	5779	(*)	
VERSYS 1000	10' - 21'	5779	(*)	
VULCAN S	15' - 21'	9024	(*)	
Z300	15' - 21'	3517	(*)	
Z400	19' - 21'	1940	(*)	
Z650	17' - 21'	9827	(*)	
Z750	03' - 12'	6419	(*)	
Z750	07' - 12'	5781	(*)	
Z750S	03' - 12'	6419	(*)	
Z750R	11' - 13'	6422	(*)	
Z800/E	13' - 16'	6423	(*)	
Z900	17' - 21'	9828	(*)	
Z900RS	17' - 21'	3518	(*)	
Z1000	03' - 06'	6419	(*)	
Z1000	03' - 06'	6419	(*)	
Z1000	07' - 09'	5780	(*)	
Z1000	10' - 14'	5782	(*)	
Z1000	15' - 21'	8489	(*)	
Z1000SX	11' - 21'	6423	(*)	
ZX-6R 636	03' - 04'	6419	(*)	
ZX-6R 636	05' - 08'	9923	(*)	
ZX-6R 636	13' - 18'	6423	(*)	
ZX-10R	04' - 07'	9923	(*)	
ZX-10R	08' - 10'	9924	(*)	
ZX-10R	11' - 16'	6423	(*)	
ZX-10R/RR	17' - 20'	9865	(*)	
ZZR1200	02' - 05'	9925	(*)	
ZZR1400	06' - 21'	6163	(*)	

2022 For the new 2022 motorcycle models check www.puig.tv				
MODEL	YEAR	REF.	N	
KTM				
125 DUKE	11' - 16'	9926	(*)	
125 DUKE	17' - 21'	9927	(*)	
200 DUKE	11' - 16'	9926	(*)	
390 DUKE	11' - 16'	9926	(*)	
390 DUKE	17' - 21'	9927	(*)	
690 DUKE	08' - 11'	9928	(*)	
690 DUKE	12' - 17'	3519	(*)	
690 DUKE R	08' - 11'	9928	(*)	
690 DUKE R	12' - 17'	3519	(*)	
790 DUKE	18' - 21'	9929	(*)	
790 ADVENTURE/R	19' - 21'	3682	(*)	
990 ADVENTURE	03' - 12'	6169	(*)	
1050 ADVENTURE	13' - 16'	9026	(*)	
1090 ADVENTURE/R	16' - 21'	20475	(*)	
1190 ADVENTURE	13' - 16'	9026	(*)	
1290 SUPERDUKE R	14' - 19'	9025	(*)	
1290 SUPERDUKE R	20' - 21'	20474	(*)	
1290 SUPEDUKE GT	12' - 21'	9025	(*)	
1290 SUPER ADVENTURE R	16' - 21'	20475	(*)	
KYMCO				
AK550	18' - 21'	3683	(*)	
PIAGGIO				
GTS 125	07 - 21'	20476	(*)	
GTS 300	08 - 21'	20476	(*)	
SUZUKI				
BURGMAN 400	07' - 17'	9829	(*)	
BURGMAN 650	02' - 11'	9830	(*)	
BURGMAN 650	12' - 21'	9831	(*)	
B-KING	07' - 12'	9934	(*)	
DL250 V-STROM	17' - 21'	0030	(*)	
DL650 V-STROM	04' - 11'	5791	(*)	
DL650 V-STROM	12' - 21'	6159	(*)	
DL650XT V-STROM	12' - 21'	6159	(*)	
DL1000XT V-STROM	04' - 11'	5791	(*)	

2022 For the new 2022 motorcycle models check www.puig.tv				
MODEL	YEAR	REF.	N	
DL1000 V-STROM	02' - 08'	5791	(*)	
DL1000 V-STROM	14' - 21'	3663	(*)	
GSF600S BANDIT	00' - 04'	6433	(*)	
GSF650 BANDIT	09' - 16'	5789	(*)	
GSF650 BANDIT	05' - 08'	5787	(*)	
GSF650S BANDIT	09' - 16'	5789	(*)	
GSF650S BANDIT	05' - 08'	5787	(*)	
GSF1200 BANDIT	06' - 16'	5787	(*)	
GSF1200S BANDIT	06' - 16'	5787	(*)	
GSF1200S BANDIT	01' - 05'	6433	(*)	
GSF1250 BANDIT	10' - 16'	5789	(*)	
GSF1250S BANDIT	10' - 16'	5789	(*)	
GSF1250S BANDIT	06' - 16'	5787	(*)	
GSF1250S BANDIT	06' - 16'	5787	(*)	
GSR600	06' - 08'	5792	(*)	
GSR750	11' - 16'	6176	(*)	
GSX650F	08' - 12'	5787	(*)	
GSX650F	08' - 17'	5790	(*)	
GSX1250F	10' - 17'	5790	(*)	
GSX1250 FA	10' - 16'	5787	(*)	
GSX-R125/250	17' - 21'	9930	(*)	
GSX-R600	01' - 03'	9936	(*)	
GSX-R600	04' - 05'	9937	(*)	
GSX-R750	00' - 02'	9936	(*)	
GSX-R750	03' - 05'	9937	(*)	
GSX-R1000	01' - 02'	9936	(*)	
GSX-R1000	03' - 04'	9937	(*)	
GSX-R1000/R	17' - 21'	9931	(*)	
GSX-R1300 HAYABUSA	99' - 07'	9932	(*)	
GSX-R1300 HAYABUSA	99' - 17'	9933	(*)	
GSX-S1000	15' - 21'	8493	(*)	
GSX-S1000F	15' - 21'	8493	(*)	
KATANA	19' - 21'	3724	(*)	
SV650	03' - 15'	6165	(*)	
SV650S	03' - 15'	6165	(*)	

NOTE: MANUFACTURED IN ABS MATERIAL.
IT ATTACHES THROUGH ADHESIVE AND MECHANICAL PROCESSES AND PLASTIC RIVETS.

(*) Fixation with glue.
(*) Bigger extension. Check image on the our site.
(*) Check price with your distributor.

IMPORTANT: Indicate code color after part#. Example 0973A.

 N Black

NOTE: MANUFACTURED IN ABS MATERIAL.
IT ATTACHES THROUGH ADHESIVE AND MECHANICAL PROCESSES AND PLASTIC RIVETS.

(*) Fixation with glue.
(*) Bigger extension. Check image on the our site.
(*) Check price with your distributor.

IMPORTANT: Indicate code color after part#. Example 0973A.

 N Black

FRONT FENDER EXTENSION

HI-TECH PARTS

2022 For the new 2022 motorcycle models check www.puig.tv			
MODEL	YEAR	REF.	N
SFV650 GLADIUS	09' - 15'	9832	(*)
SV650	16' - 21'	9285	(*)
TRIUMPH			
BONNEVILLE BOBBER	17' - 21'	3899	(*)
BONNEVILLE BOBBER BLACK	20' - 21'	3899	(*)
BONNEVILLE SPEEDMASTER	18' - 21'	3899	(*)
BONNEVILLE SE	09' - 15'	6435	(*)
BONNEVILLE T100/T120	16' - 21'	9833	(*)
DAYTONA 675	06' - 11'	5788	(*)
DAYTONA 675 R	06' - 11'	5788	(*)
ROCKET 3	06' - 19'	3902	(*)
SCRAMBLER	06' - 16'	9287	(*)
STREET TRIPLE	06' - 11'	5788	(*)
STREET TRIPLE R	06' - 11'	5788	(*)
STREET TRIPLE	17' - 21'	3898	(*)
STREET TWIN	16' - 21'	9224	(*)
SPEED TRIPLE	11' - 16'	6424	(*)
SPEED TRIPLE	16' - 20'	3898	(*)
SPEED TRIPLE R	11' - 16'	6424	(*)
SPEED TRIPLE R	16' - 20'	3898	(*)
SPEED TRIPLE/R	06' - 10'	6161	(*)
SPEED TWIN	19' - 21'	3862	(*)
SPEEDMASTER	18' - 21'	3899	(*)
THRUXTON	04' - 16'	9287	(*)
TIGER 800	11' - 14'	6173	(*)
TIGER 800 XR/XRT/XRX	11' - 21'	6173	(*)
TIGER 800 XC/XCX/XCA	11' - 21'	9288	(*)
TIGER 900	20' - 21'	20403	(*)
TIGER 900 GT	20' - 21'	20403	(*)
TIGER 900 GT LOW	20' - 21'	20403	(*)
TIGER 900 GT PRO	20' - 21'	20403	(*)
TIGER 900 RALLY	20' - 21'	20477	(*)
TIGER 900 RALLY PRO	20' - 21'	20477	(*)
TIGER 1050	07' - 12'	6161	(*)
TIGER SPORT	13' - 21'	9128	(*)

2022 For the new 2022 motorcycle models check www.puig.tv			
MODEL	YEAR	REF.	N
TIGER EXPLORER XR/XRX/XRT	12' - 15'	6425	(*)
TIGER EXPLORER XC/XCX/XCA	12' - 15'	6425	(*)
TIGER EXPLORER XC/XRX/XRT/XCX/XCA	16' - 21'	9223	(*)
SCRAMBLER 1200 XC	19' - 21'	20808	(*)
SCRAMBLER 1200 XE	19' - 21'	20808	(*)
THRUXTON 1200	16' - 21'	20809	(*)
THRUXTON 1200 R	16' - 21'	20810	(*)
THRUXTON 1200 RS	20' - 21'	20810	(*)
YAMAHA			
FJR1300A/AS	06' - 21'	6166	(*)
FAZER8	10' - 15'	5795	(*)
FZ6	06' - 07'	5795	(*)
FZ6	04' - 05'	5796	(*)
FZ6 FAZER	06' - 07'	5795	(*)
FZ6 FAZER	04' - 05'	5796	(*)
FZ6 FAZER S2	08' - 09'	5794	(*)
FZ6 S2	08' - 09'	5794	(*)
FZ8	10' - 15'	5795	(*)
FZ8 FAZER	10' - 15'	5795	(*)
FZS1000 FAZER	01' - 05'	5795	(*)
MT-03	16' - 19'	9182	(*)
MT-07	14' - 17'	7565	(*)
MT-07	18' - 21'	0031	(*)
MT-07 TRACER	15' - 19'	9237	(*)
MT-07 TRACER	20' - 21'	20470	(*)
MT-07 TRACER GT	20' - 21'	20470	(*)
MT-09	13' - 20'	7512	(*)
MT-09 SP	18' - 20'	7512	(*)
MT-09 TRACER GT	18' - 20'	7512	(*)
MT-09 TRACER	15' - 20'	7512	(*)
MT-10	16' - 21'	9835	(*)
MT-10 SP	16' - 21'	9835	(*)
MT-125	14' - 19'	9834	(*)
TDM 900	02' - 11'	5797	(*)
TENERE 700	19' - 21'	3894	(*)

NOTE: MANUFACTURED IN ABS MATERIAL.
IT ATTACHES THROUGH ADHESIVE AND MECHANICAL PROCESSES AND PLASTIC RIVETS.

(*) Fixation with glue.
(†) Bigger extension. Check image on the our site.
(*) Check price with your distributor.

IMPORTANT: Indicate code color after part#. Example 0973A.

 N Black

2022 For the new 2022 motorcycle models check www.puig.tv			
MODEL	YEAR	REF.	N
T-MAX 530	12' - 21'	3666	(*)
TRX850	95' - 00'	6434	(*)
XJ6	09' - 16'	5796	(*)
XJ6 DIVERSION	09' - 16'	5796	(*)
XJ6 DIVERSION F	09' - 16'	5796	(*)
XJR1200	95' - 99'	6434	(*)
XJR1300	99' - 16'	6434	(*)
XT660Z TÉNÉRÉ	08' - 16'	9836	(*)
XT1200Z SUPER TÉNÉRÉ	10' - 21'	6162	(*)
XT1200ZE SUPER TENERE	19' - 21'	6162	(*)
X-MAX 125	18' - 21'	3664	(*)
X-MAX 300	17' - 21'	3664	(*)
X-MAX 400	17' - 21'	3664	(*)
XSR700	16' - 21'	9183	(*)
XSR900	16' - 21'	9184	(*)
XV950	13' - 16'	9289	(*)
XV950R	13' - 16'	9289	(*)
YZF-R125	08' - 13'	9935	(*)
YZF-R125	14' - 21'	9834	(*)
YZF-R1	09' - 21'	9835	(*)
YZF-R3	15' - 18'	9182	(*)
YZF-R6	03' - 05'	5795	(*)
MT-09	21'	20811	(*)
MT-09 SP	21'	20811	(*)
MT-09 TRACER	21'	20811	(*)
MT-09 TRACER GT	21'	20811	(*)
SPARES			
PLASTIC RIVET		20526	(*)

NOTE: MANUFACTURED IN ABS MATERIAL.
IT ATTACHES THROUGH ADHESIVE AND MECHANICAL PROCESSES AND PLASTIC RIVETS.

(*) Fixation with glue.
(†) Bigger extension. Check image on the our site.
(*) Check price with your distributor.

IMPORTANT: Indicate code color after part#. Example 0973A.

 N Black



AXLE SLIDERS PHB19

HI-TECH PARTS | TECHNICAL SECTION



* Check availability for motorcycle models at www.puig.tv typing in the searching window.



DESIGN
Racing look for your motorcycle.

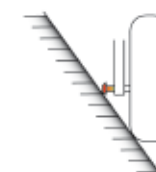

COMPLETE PROTECTION
Fork and swing arm protection.

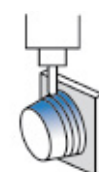

MATERIAL
Manufactured through a nylon block.

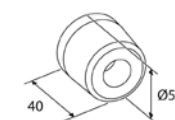

DIMENSIONS



265gr.

WEIGHT
Reduced to 265 grams.



The set of anodized aluminium rings must be ordered separately from the sliders, depending on the color of the bike.

N Black

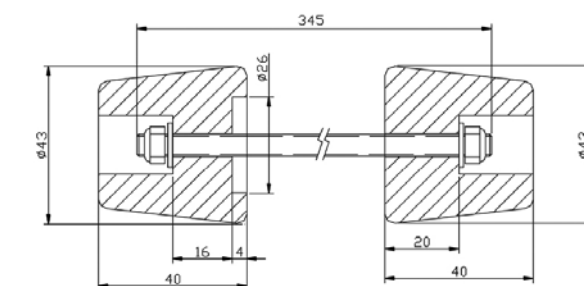

MODEL	REF.	N
UNIVERSAL	20097	(*)

SPARES	REF.	N	A	T	O
			P	R	V
NYLON MOD. UNIVERSAL RIGHT SIDE	20098	(*)			
NYLON MOD. UNIVERSAL LEFT SIDE	20099	(*)			
SET OF ANODIZED ALUMINIUM RINGS	20025	(*)	(*)		
ANODIZED ALUMINIUM RING SET FOR AXLE SLIDER	20271	(*)	(*)		

(*) Check price with your distributor.
IMPORTANT: Indicate code color after part#. Example 0973A.

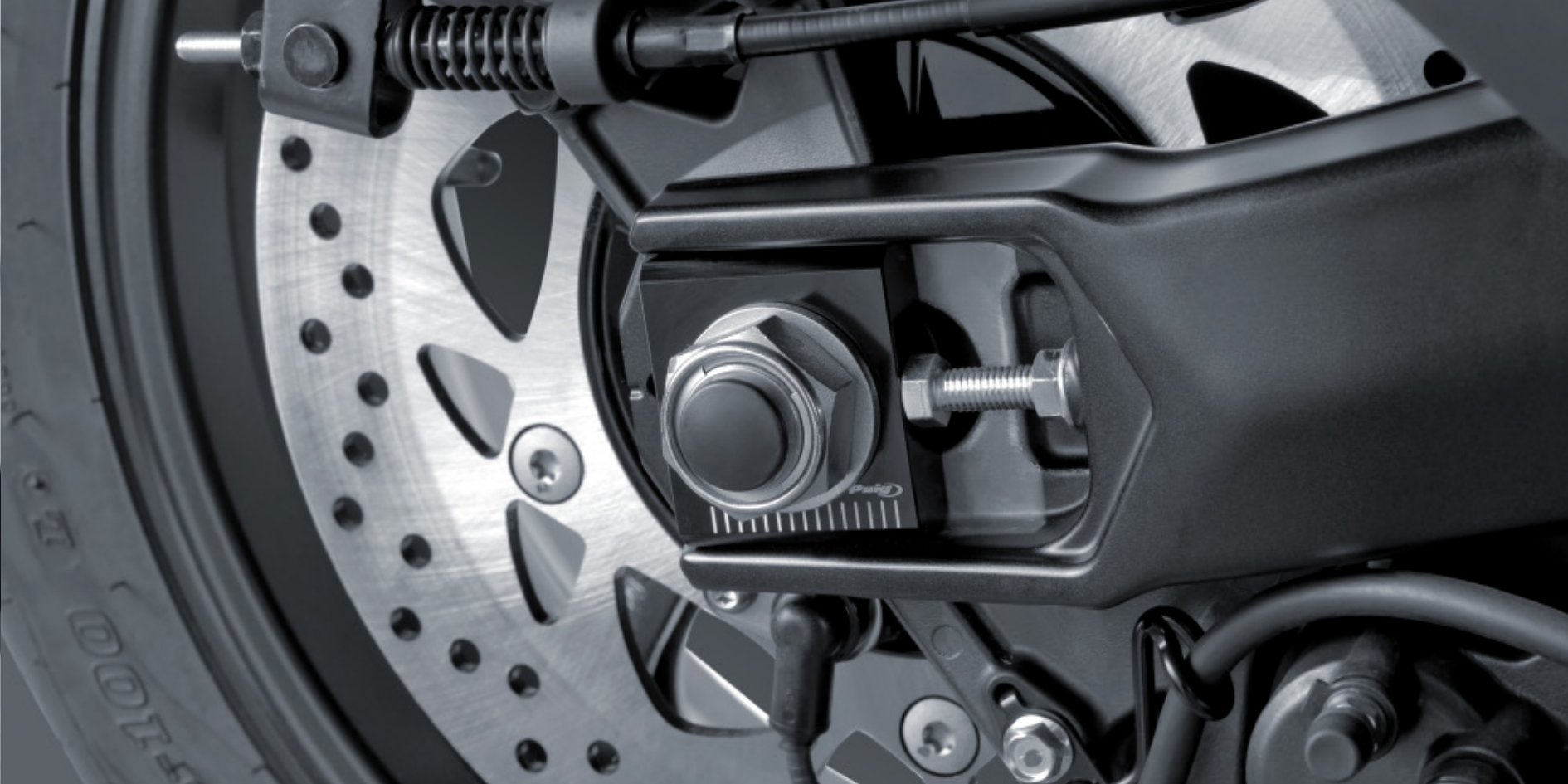

VALVES

HI-TECH PARTS | TECHNICAL SECTION

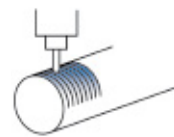

MATERIAL
Manufactured through billet aluminium.

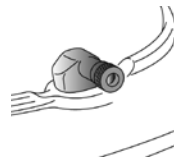
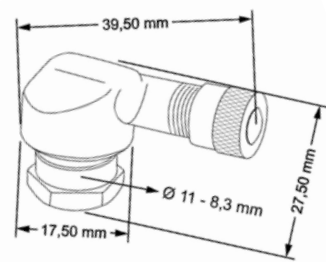

DESIGN
Developed to ease the inflation process.



WEIGHT
Reduced to 8 grams.

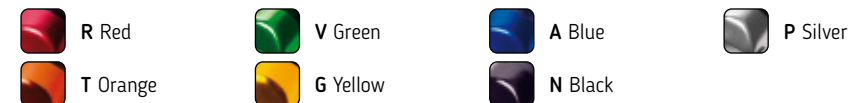

REF. 5591V



MODEL	Ø WHEEL HOLE	REF.	A G N P R V T
UNIVERSAL BY PAIR	11 mm.	5591	(*)
UNIVERSAL BY PAIR	8,3 mm.	8100	(*)

(*) Check price with your distributor.
IMPORTANT: Indicate code color after part#. Example 0973A.

TENSORS FOR REAR WHEEL BY PAIR

HI-TECH PARTS | TECHNICAL SECTION

MODEL	YEAR	REF.	N
KYMCO			
AK550	17' - 21'	9545	(*)
YAMAHA			
T-MAX 530	12' - 16'	7357	(*)
T-MAX 530/DX/SX	17' - 19'	7357	(*)
T-MAX 560 /SX/DX/MAX TECH	20' - 21'	7357	(*)

N Black

REF. 7357N



(*) Check price with your distributor.
IMPORTANT: Indicate code color after part#. Example 0973A.



ADHESIVE STRIPS

HI-TECH PARTS



YELLOW FLUORESCENT

STRIP WITHOUT APLICATOR	PRICE
2568G	(*)
STRIP WITH APLICATOR	PRICE
4542G	(*)

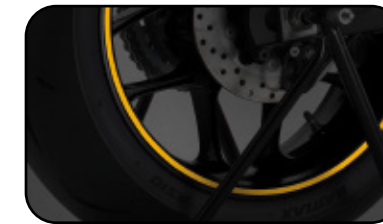

YELLOW REFLECTIVE

STRIP WITHOUT APLICATOR	PRICE
2568O	(*)
STRIP WITH APLICATOR	PRICE
4542O	(*)

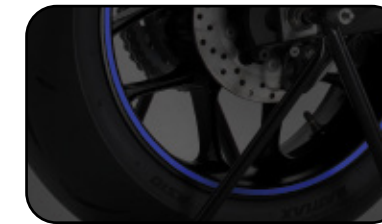

BLUE REFLECTIVE

STRIP WITHOUT APLICATOR	PRICE
2568A	(*)
STRIP WITH APLICATOR	PRICE
4542A	(*)

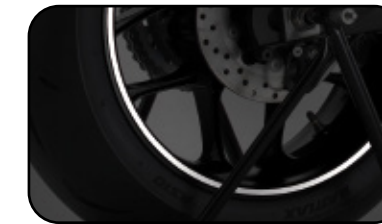

WHITE REFLECTIVE

STRIP WITHOUT APLICATOR	PRICE
2568B	(*)
STRIP WITH APLICATOR	PRICE
4542B	(*)



PURE WHITE

STRIP WITHOUT APLICATOR	PRICE
2568M	(*)
STRIP WITH APLICATOR	PRICE
4542M	(*)



CARBON LOOK

STRIP WITHOUT APLICATOR	PRICE
2568C	(*)
STRIP WITH APLICATOR	PRICE
4542C	(*)



ORANGE FLUORESCENT

STRIP WITHOUT APLICATOR	PRICE
2568T	(*)
STRIP WITH APLICATOR	PRICE
4542T	(*)

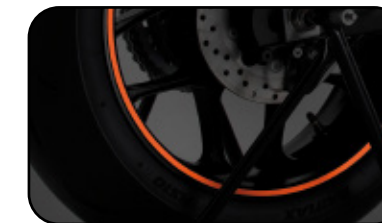

ORANGE REFLECTIVE

STRIP WITHOUT APLICATOR	PRICE
2568X	(*)
STRIP WITH APLICATOR	PRICE
4542X	(*)



MATT BLACK

STRIP WITHOUT APLICATOR	PRICE
2568N	(*)
STRIP WITH APLICATOR	PRICE
4542N	(*)

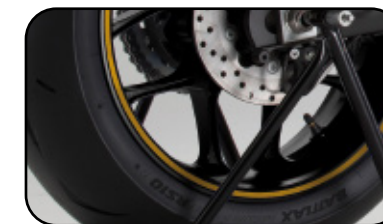

GOLD

STRIP WITHOUT APLICATOR	PRICE
2568Z	(*)
STRIP WITH APLICATOR	PRICE
4542Z	(*)

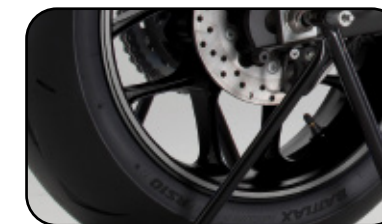

SILVER

STRIP WITHOUT APLICATOR	PRICE
2568P	(*)
STRIP WITH APLICATOR	PRICE
4542P	(*)



PINK

STRIP WITHOUT APLICATOR	PRICE
2568Q	(*)
STRIP WITH APLICATOR	PRICE
4542Q	(*)

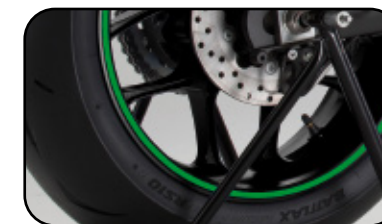

GREEN FLUORESCENT

STRIP WITHOUT APLICATOR	PRICE
2568V	(*)
STRIP WITH APLICATOR	PRICE
4542V	(*)

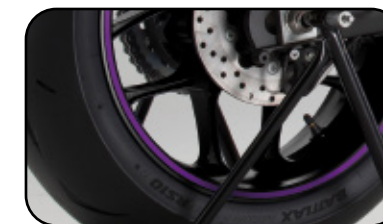

PURPLE

STRIP WITHOUT APLICATOR	PRICE
2568L	(*)
STRIP WITH APLICATOR	PRICE
4542L	(*)

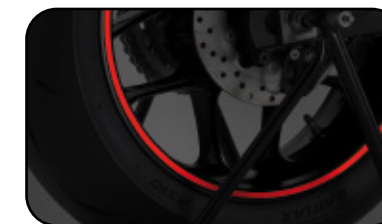

RED REFLECTIVE

STRIP WITHOUT APLICATOR	PRICE
2568R	(*)
STRIP WITH APLICATOR	PRICE
4542R	(*)

STRIP SIZE 7 mm. WIDTH x 6 m. LENGTH. TO BE APPLIED ON THE WHEEL FROM 16" TO 18".

(*) Check price with your distributor.
IMPORTANT: Indicate code color after part#. Example 0973A.

ADHESIVE STRIPS PREMIUM

HI-TECH PARTS



YELLOW FLUORESCENT

MODEL	REF.	G
YELLOW FLUORESCENT	8431G	(*)



BLUE FLUORESCENT

MODEL	REF.	A
BLUE FLUORESCENT	8431A	(*)



WHITE FLUORESCENT

MODEL	REF.	B
WHITE FLUORESCENT	8431B	(*)



ORANGE FLUORESCENT

MODEL	REF.	T
ORANGE FLUORESCENT	8431T	(*)



RED FLUORESCENT

MODEL	REF.	R
RED FLUORESCENT	8431R	(*)



GREEN FLUORESCENT

MODEL	REF.	V
GREEN FLUORESCENT	8431V	(*)



NOTE: THE SET CONSISTS ON 8 RIM STRIPS FOR 14" AND 21" RIMS.
MATERIAL: PVC LENTICULAR SEMI RIGID APPLIED ON RIMS OF 14" TO 21".

(*) Check price with your distributor.
IMPORTANT: Indicate code color after part#. Example 0973A.



SPECIAL RIM STRIPS

HI-TECH PARTS

9133A		9134G		9311B		9293B	
9133B		9134R		9311T		9293A	
9133R		9134V		9311V		9293R	
9133P		5528V		9290B		9293P	
5524A		5528B		9290T		9630P	
5524B		5527R		9290V		9630R	
5524R		9136A		5545B		9630A	
5989B		9136R		5545T		96300	
5989R		9136P		5545V		5532B	
5525A		9135A		6561B		55320	
5525B		9135P		6561T		5532P	
5525P		9135R		6561V		5531A	
9442A		5529B		9291B		5531B	
9442R		5529P		9291T		5531G	
5526P		9292A		9291V		5531P	
5559B		9292B		7590B		5531R	
5559P		9292R		7590T		55310	
5530P		9292V		7590V		5531V	
						9985P	





NOTE: THE SET CONSISTS ON 8 RIM STRIPS FOR 14" AND 21" RIMS.
MATERIAL: PVC LENTICULAR SEMI RIGID APPLIED ON RIMS OF 14" TO 21".

SPECIAL RIM STRIPS

HI-TECH PARTS

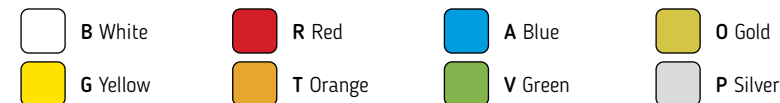
2022 For the new 2022 motorcycle models check www.puig.tv				
MODEL	YEAR	REF.		
BMW				
R NINE T	14' - 20'	9133	(*)	
R NINE T SCRAMBLER	16' - 20'	9133	(*)	
R NINE T PURE	17' - 20'	9133	(*)	
R NINE T RACER	17' - 20'	9133	(*)	
R NINE T URBAN G/S	17' - 20'	9133	(*)	
DUCATI				
MONSTER 696	08' - 14'	5527	(*)	
MONSTER 796	18' - 21'	5527	(*)	
MONSTER 797	17' - 20'	5527	(*)	
MONSTER 821	14' - 20'	5527	(*)	
MONSTER 1100	09' - 10'	5527	(*)	
MONSTER 1100 EVO	11' - 13'	5527	(*)	
MONSTER 1200/S	14' - 21'	5527	(*)	
MONSTER 1200 R	16' - 20'	5527	(*)	
SCRAMBLER ICON/CLASSIC/FULL THROTTLE	15' - 21'	9134	(*)	
SCRAMBLER SIXTY2	16' - 21'	9134	(*)	
SCRAMBLER URBAN ENDURO	15' - 16'	9134	(*)	
SCRAMBLER FLAT TRACK PRO	16'	9134	(*)	
SCRAMBLER DESERT SLED	17' - 20'	9134	(*)	
SCRAMBLER CAFE RACER	17' - 21'	9134	(*)	
SCRAMBLER 1100	18' - 21'	9134	(*)	
SCRAMBLER 1100 SPORT	18' - 21'	9134	(*)	
SCRAMBLER 1100 SPECIAL	18' - 21'	9134	(*)	
HONDA				
CB600F HORNET	98' - 16'	5526	(*)	
CB900F HORNET	02' - 05'	5526	(*)	
CBR250R	11' - 14'	5524	(*)	
CBR500R	13' - 18'	5524	(*)	
CBR600F	86' - 07'	5524	(*)	
CBR600F	11' - 13'	5524	(*)	
CBR650F	14' - 16'	5524	(*)	
CBR650F	17' - 18'	5524	(*)	
CBR600RR	03' - 06'	5524	(*)	
CBR600RR	07' - 16'	5524	(*)	
CBR900RR FIRE BLADE	96' - 99'	5524	(*)	



2022 For the new 2022 motorcycle models check www.puig.tv				
MODEL	YEAR	REF.		
CBR900RR FIRE BLADE	00' - 01'	5524	(*)	
CBR900RR FIRE BLADE	02' - 03'	5524	(*)	
CBR1000RR FIREBLADE	04' - 07'	5524	(*)	
CBR1000RR FIREBLADE	08' - 11'	5524	(*)	
CBR1000RR FIREBLADE	12' - 16'	5524	(*)	
CBR1000RR FIREBLADE/SP/SP2	17' - 21'	5524	(*)	
SCOOPIY 80		5559	(*)	
SCOOPIY SH50		5559	(*)	
SCOOPIY SH100		5559	(*)	
SCOOPIY SH125	02' - 06'	5559	(*)	
SCOOPIY SH125i	07' - 08'	5559	(*)	
SCOOPIY SH125i (rear brake disk)	09' - 10'	5559	(*)	
SCOOPIY SH125i (rear brake disk)	11' - 12'	5559	(*)	
SCOOPIY SH125i	18' - 21'	5559	(*)	
SCOOPIY SH125i	18' - 21'	5559	(*)	
SCOOPIY SH150	18' - 21'	5559	(*)	
SCOOPIY SH150i	18' - 21'	5559	(*)	
SCOOPIY SH150i (rear brake disk)	18' - 21'	5559	(*)	
SCOOPIY SH150i (rear brake disk)	18' - 21'	5559	(*)	
SCOOPIY SH150i	18' - 21'	5559	(*)	
SCOOPIY SH150i	18' - 21'	5559	(*)	
SCOOPIY SH300i	07' - 10'	5559	(*)	
SCOOPIY SH300i	11' - 14'	5559	(*)	
SCOOPIY SH300i	15' - 17'	5559	(*)	
KAWASAKI				
ER-6F	06' - 16	9311	(*)	
ER-6N	06' - 16'	9311	(*)	
NINJA H2	15' - 21'	5528	(*)	
NINJA 250R	08' - 12'	5528	(*)	
NINJA 250SL	18' - 21'	5528	(*)	
NINJA 300	18' - 21'	5528	(*)	
NINJA 400	18' - 21'	5528	(*)	
NINJA 650	18' - 21'	5528	(*)	
Z650	18' - 21'	9290	(*)	
Z750	18' - 21'	5545	(*)	
Z750	18' - 21'	5545	(*)	

(*) Check price with your distributor.
IMPORTANT: Indicate code color after part#. Example 0973A.

2022 For the new 2022 motorcycle models check www.puig.tv				
MODEL	YEAR	REF.		
Z750R	18' - 21'	5545	(*)	
Z800	19' - 21'	6561	(*)	
Z800E	19' - 21'	6561	(*)	
Z900	19' - 21'	9291	(*)	
Z900RS	19' - 21'	9291	(*)	
Z1000	19' - 21'	7590	(*)	
Z1000/R	19' - 21'	7590	(*)	
Z1000SX	19' - 21'	7590	(*)	
ZX-6R	19' - 21'	9292	(*)	
ZX-6R	00' - 04'	9292	(*)	
ZX-6R	05' - 06'	9292	(*)	
ZX-6R	07' - 16'	9292	(*)	
ZX-6R	18' - 21'	9292	(*)	
ZX-6R 636	13' - 16'	9292	(*)	
ZX-9R	98' - 04'	9292	(*)	
ZX-9R	00' - 04'	9292	(*)	
ZX-10R	04' - 20'	9292	(*)	
ZX-10RR	17' - 20'	9292	(*)	
ZX-10R SE	18' - 20'	9292	(*)	
ZX-12R	00' - 06'	9292	(*)	
KYMCO				
AK550	17' - 21'	9630	(*)	
SUZUKI				
GSR600	06' - 11'	5989	(*)	
GSR750	11' - 16'	5989	(*)	
GSX-R125	17' - 21'	5525	(*)	
GSX-R250	17' - 21'	5525	(*)	
GSX-R600	96' - 17'	5525	(*)	
GSX-R750	96' - 17'	5525	(*)	
GSX-R1000	01' - 16'	5525	(*)	
GSX-R1000/R	17' - 20'	5525	(*)	
GSX-R1300 HAYABUSA	99' - 07'	5525	(*)	
GSX-S125	17' - 21'	9442	(*)	
GSX-S750	17' - 21'	9442	(*)	
GSX-S1000	15' - 21'	9442	(*)	
GSX-S1000F	15' - 21'	9442	(*)	

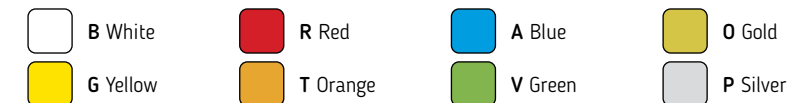

(*) Check price with your distributor.
IMPORTANT: Indicate code color after part#. Example 0973A.

2022 For the new 2022 motorcycle models check www.puig.tv				
MODEL	YEAR	REF.		
YAMAHA				
MT-07	14' - 21'	9136	(*)	
MT-07 TRACER	16' - 21'	9136	(*)	
MT-07 TRACER	14' - 21'	9293	(*)	
MT-07 TRACER GT	19' - 21'	9136	(*)	
MT-07 TRACER GT	19' - 21'	9293	(*)	
MT-09	13' - 16'	9135	(*)	
MT-09	17' - 20'	9135	(*)	
MT-09 SP	18' - 20'	9135	(*)	
MT-09 TRACER	15' - 20'	9135	(*)	
MT-09 TRACER GT	18' - 20'	9135	(*)	
MT-09 TRACER	15' - 20'	9293	(*)	
MT-09 TRACER GT	18' - 20'	9293	(*)	
XSR700	16' - 21'	9985	(*)	
XSR700 XTRIBUTE	19' - 21'	9985	(*)	
XSR900	16' - 21'	9985	(*)	
YZF-R1	99' - 21'	5529	(*)	
YZF-R1M	17' - 21'	5529	(*)	
YZF-R6	99' - 20'	5530	(*)	
T-MAX 500	08' - 11'	5532	(*)	
T-MAX 530	12' - 16	5532	(*)	
T-MAX 530/DX/SX	17' - 19'	5532	(*)	
T-MAX 560 /SX/DX/MAX TECH	20' - 21'	5532	(*)	
UNIVERSAL				
RACING		5531	(*)	



RIM STRIPS GS

HI-TECH PARTS | TECHNICAL SECTION



MODEL	YEAR	REF.	N	O
BMW				
R1200GS	13' - 18'	20150	(*)	
R1200GS ADVENTURE	14' - 18'	20151	(*)	
R1200GS EXCLUSIVE	17' - 18'	20150	(*)	
R1200GS RALLYE	17' - 18'	20150	(*)	
R1250GS ADVENTURE	18' - 21'	20151	(*)	
R1250GS HP	18' - 21'	20150	(*)	
R1250GS	18' - 21'	20150	(*)	
R1250GS RALLYE	18' - 21'	20150	(*)	
S1000 XR	15' - 19'	20214	(*)	

N Black

O Gold

(*) Check price with your distributor.
IMPORTANT: Indicate code color after part#. Example 0973A.

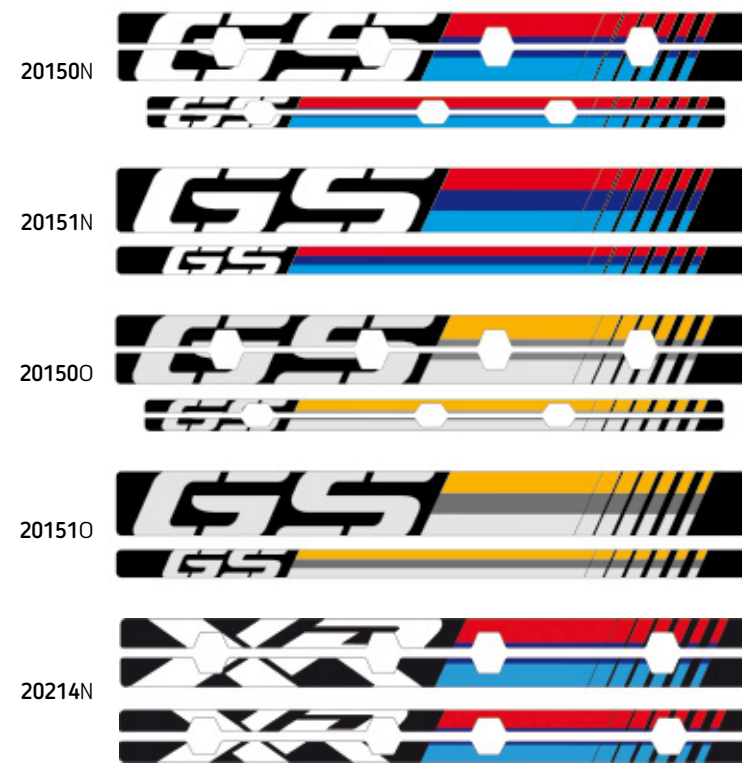

SWING ARM PROTECTOR GS

HI-TECH PARTS | TECHNICAL SECTION



MODEL	YEAR	REF.	B	N	O
BMW					
R1200GS	04' - 12'	20152	(*)		
R1200GS	13' - 18'	20153	(*)		
R1200GS ADVENTURE	06' - 13'	20152	(*)		
R1200GS ADVENTURE	14' - 18'	20153	(*)		
R1200GS EXCLUSIVE	17' - 18'	20153	(*)		
R1200GS RALLYE	17' - 18'	20153	(*)		
R1250GS	18' - 21'	20153	(*)		
R1250GS ADVENTURE	18' - 21'	20153	(*)		
R1250GS HP	18' - 21'	20153	(*)		
R1250GS RALLYE	18' - 21'	20153	(*)		
DUCATI					
MULTISTRADA 1200 ENDURO/PRO	16' - 18'	20213	(*)		
MULTISTRADA 1260 ENDURO	19' - 21'	20213	(*)		



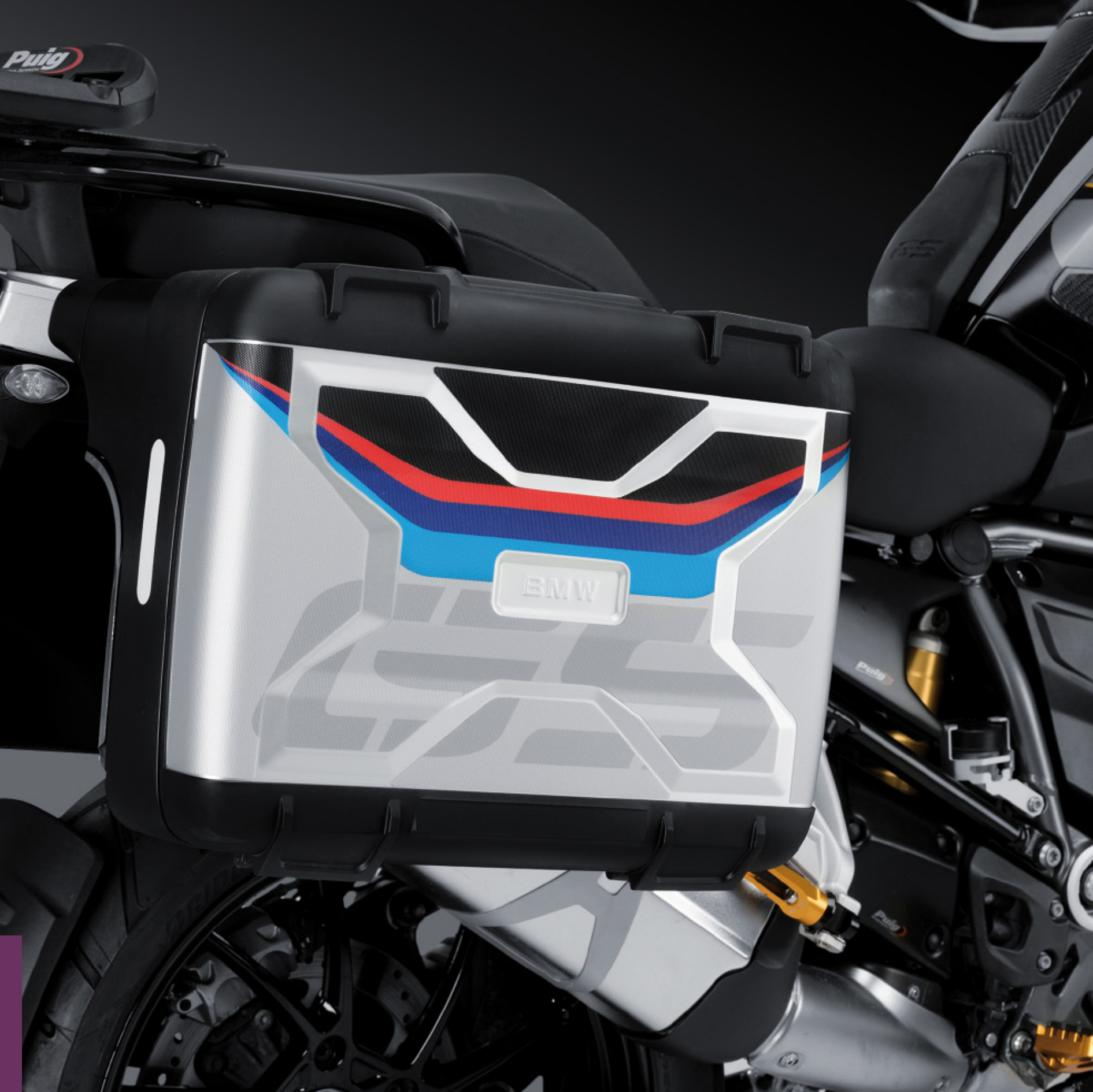

ADHESIVE KIT FOR BMW CASES

HI-TECH PARTS | TECHNICAL SECTION



REF. 20216N



REF. 20217N



REF. 20227N



REF. 20228N



REF. 20229N



REF. 20230N



REF. 20231N



REF. 20232N

■ N Black

NOTE: THE KIT INCLUDES ADHESIVES FOR ONE CASE. IF YOU HAVE THREE CASES, YOU MUST ORDER 3 UNITS OF THE REFERENCE.

(*) Check price with your distributor.

IMPORTANT: Indicate code color after part#. Example 0973A.

ADHESIVE KIT FOR BMW CASES

HI-TECH PARTS

2022					
For the new 2022 motorcycle models check www.puig.tv					
MODEL	YEAR	CASE MODEL	REF.	N	
BMW					
F700GS	12' - 17'	SIDE CASE VARIO GS	20216	(*)	
F700GS	12' - 17'	SIDE CASE VARIO NAVIGATOR	20227	(*)	
F700GS	12' - 17'	CASE TOPCASE VARIO GS	20229	(*)	
F700GS	12' - 17'	CASE TOPCASE VARIO NAVIGATOR	20230	(*)	
F700GS	12' - 17'	SIDE CASE ADVENTURE GS	20217	(*)	
F700GS	12' - 17'	SIDE CASE ADVENTURE NAVIGATOR	20228	(*)	
F700GS	12' - 17'	CASE TOPCASE ADVENTURE GS	20231	(*)	
F700GS	12' - 17'	CASE TOPCASE ADVENTURE NAVIGATOR	20232	(*)	
F750GS	18' - 21'	SIDE CASE VARIO GS	20216	(*)	
F750GS	18' - 21'	SIDE CASE VARIO NAVIGATOR	20227	(*)	
F750GS	18' - 21'	CASE TOPCASE VARIO GS	20229	(*)	
F750GS	18' - 21'	CASE TOPCASE VARIO NAVIGATOR	20230	(*)	
F750GS	18' - 21'	SIDE CASE ADVENTURE GS	20217	(*)	
F750GS	18' - 21'	SIDE CASE ADVENTURE NAVIGATOR	20228	(*)	
F750GS	18' - 21'	CASE TOPCASE ADVENTURE GS	20231	(*)	
F750GS	18' - 21'	CASE TOPCASE ADVENTURE NAVIGATOR	20232	(*)	
F800GS	08' - 17'	SIDE CASE VARIO GS	20216	(*)	
F800GS	08' - 17'	SIDE CASE VARIO NAVIGATOR	20227	(*)	
F800GS	08' - 17'	CASE TOPCASE VARIO GS	20229	(*)	
F800GS	08' - 17'	CASE TOPCASE VARIO NAVIGATOR	20230	(*)	
F800GS	08' - 17'	SIDE CASE ADVENTURE GS	20217	(*)	
F800GS	08' - 17'	SIDE CASE ADVENTURE NAVIGATOR	20228	(*)	
F800GS	08' - 17'	CASE TOPCASE ADVENTURE GS	20231	(*)	
F800GS	08' - 17'	CASE TOPCASE ADVENTURE NAVIGATOR	20232	(*)	
F850GS	18' - 21'	SIDE CASE VARIO GS	20216	(*)	
F850GS	18' - 21'	SIDE CASE VARIO NAVIGATOR	20227	(*)	
F850GS	18' - 21'	CASE TOPCASE VARIO GS	20229	(*)	
F850GS	18' - 21'	CASE TOPCASE VARIO NAVIGATOR	20230	(*)	
F850GS	18' - 21'	SIDE CASE ADVENTURE GS	20217	(*)	
F850GS	18' - 21'	SIDE CASE ADVENTURE NAVIGATOR	20228	(*)	
F850GS	18' - 21'	CASE TOPCASE ADVENTURE GS	20231	(*)	
F850GS	18' - 21'	CASE TOPCASE ADVENTURE NAVIGATOR	20232	(*)	
F850GS ADVENTURE	19' - 21'	SIDE CASE VARIO GS	20216	(*)	
F850GS ADVENTURE	19' - 21'	SIDE CASE VARIO NAVIGATOR	20227	(*)	
F850GS ADVENTURE	19' - 21'	CASE TOPCASE VARIO GS	20229	(*)	

NOTE: THE KIT INCLUDES ADHESIVES FOR ONE CASE.
IF YOU HAVE THREE CASES, YOU MUST ORDER 3 UNITS OF THE REFERENCE.

(*) Check price with your distributor.

IMPORTANT: Indicate code color after part#. Example 0973A.

 N Black

2022		For the new 2022 motorcycle models check www.puig.tv			
MODEL	YEAR	CASE MODEL	REF.	N	
F850GS ADVENTURE	19' - 21'	CASE TOPCASE VARIO NAVIGATOR	20230	(*)	
F850GS ADVENTURE	19' - 21'	SIDE CASE ADVENTURE GS	20217	(*)	
F850GS ADVENTURE	19' - 21'	SIDE CASE ADVENTURE NAVIGATOR	20228	(*)	
F850GS ADVENTURE	19' - 21'	CASE TOPCASE ADVENTURE GS	20231	(*)	
F850GS ADVENTURE	19' - 21'	CASE TOPCASE ADVENTURE NAVIGATOR	20232	(*)	
R1200GS	04' - 12'	SIDE CASE VARIO GS	20216	(*)	
R1200GS	04' - 12'	SIDE CASE VARIO NAVIGATOR	20227	(*)	
R1200GS	04' - 12'	CASE TOPCASE VARIO GS	20229	(*)	
R1200GS	04' - 12'	CASE TOPCASE VARIO NAVIGATOR	20230	(*)	
R1200GS	04' - 12'	SIDE CASE ADVENTURE GS	20217	(*)	
R1200GS	04' - 12'	SIDE CASE ADVENTURE NAVIGATOR	20228	(*)	
R1200GS	04' - 12'	CASE TOPCASE ADVENTURE GS	20231	(*)	
R1200GS	04' - 12'	CASE TOPCASE ADVENTURE NAVIGATOR	20232	(*)	
R1200GS	13' - 18'	SIDE CASE VARIO GS	20216	(*)	
R1200GS	13' - 18'	SIDE CASE VARIO NAVIGATOR	20227	(*)	
R1200GS	13' - 18'	CASE TOPCASE VARIO GS	20229	(*)	
R1200GS	13' - 18'	CASE TOPCASE VARIO NAVIGATOR	20230	(*)	
R1200GS	13' - 18'	SIDE CASE ADVENTURE GS	20217	(*)	
R1200GS	13' - 18'	SIDE CASE ADVENTURE NAVIGATOR	20228	(*)	
R1200GS	13' - 18'	CASE TOPCASE ADVENTURE GS	20231	(*)	
R1200GS	13' - 18'	CASE TOPCASE ADVENTURE NAVIGATOR	20232	(*)	
R1200GS EXCLUSIVE	17' - 18'	SIDE CASE VARIO GS	20216	(*)	
R1200GS EXCLUSIVE	17' - 18'	SIDE CASE VARIO NAVIGATOR	20227	(*)	
R1200GS EXCLUSIVE	17' - 18'	CASE TOPCASE VARIO GS	20229	(*)	
R1200GS EXCLUSIVE	17' - 18'	CASE TOPCASE VARIO NAVIGATOR	20230	(*)	
R1200GS EXCLUSIVE	17' - 18'	SIDE CASE ADVENTURE GS	20217	(*)	
R1200GS EXCLUSIVE	17' - 18'	SIDE CASE ADVENTURE NAVIGATOR	20228	(*)	
R1200GS EXCLUSIVE	17' - 18'	CASE TOPCASE ADVENTURE GS	20231	(*)	
R1200GS EXCLUSIVE	17' - 18'	CASE TOPCASE ADVENTURE NAVIGATOR	20232	(*)	
R1200GS RALLYE	17' - 18'	SIDE CASE VARIO GS	20216	(*)	
R1200GS RALLYE	17' - 18'	SIDE CASE VARIO NAVIGATOR	20227	(*)	
R1200GS RALLYE	17' - 18'	CASE TOPCASE VARIO GS	20229	(*)	
R1200GS RALLYE	17' - 18'	CASE TOPCASE VARIO NAVIGATOR	20230	(*)	
R1200GS RALLYE	17' - 18'	SIDE CASE ADVENTURE GS	20217	(*)	
R1200GS RALLYE	17' - 18'	SIDE CASE ADVENTURE NAVIGATOR	20228	(*)	
R1200GS RALLYE	17' - 18'	CASE TOPCASE ADVENTURE GS	20231	(*)	
R1200GS RALLYE	17' - 18'	CASE TOPCASE ADVENTURE NAVIGATOR	20232	(*)	
R1200GS ADVENTURE	06' - 13'	SIDE CASE VARIO GS	20216	(*)	
R1200GS ADVENTURE	06' - 13'	SIDE CASE VARIO NAVIGATOR	20227	(*)	

NOTE: THE KIT INCLUDES ADHESIVES FOR ONE CASE.
IF YOU HAVE THREE CASES, YOU MUST ORDER 3 UNITS OF THE REFERENCE.

(*) Check price with your distributor.

IMPORTANT: Indicate code color after part#. Example 0973A.

 N Black

ADHESIVE KIT FOR BMW CASES

HI-TECH PARTS

2022				
For the new 2022 motorcycle models check www.puig.tv				
MODEL	YEAR	CASE MODEL	REF.	N
R1200GS ADVENTURE	06' - 13'	CASE TOPCASE VARIO GS	20229	(*)
R1200GS ADVENTURE	06' - 13'	CASE TOPCASE VARIO NAVIGATOR	20230	(*)
R1200GS ADVENTURE	06' - 13'	SIDE CASE ADVENTURE GS	20217	(*)
R1200GS ADVENTURE	06' - 13'	SIDE CASE ADVENTURE NAVIGATOR	20228	(*)
R1200GS ADVENTURE	06' - 13'	CASE TOPCASE ADVENTURE GS	20231	(*)
R1200GS ADVENTURE	06' - 13'	CASE TOPCASE ADVENTURE NAVIGATOR	20232	(*)
R1200GS ADVENTURE	14' - 18'	SIDE CASE VARIO GS	20216	(*)
R1200GS ADVENTURE	14' - 18'	SIDE CASE VARIO NAVIGATOR	20227	(*)
R1200GS ADVENTURE	14' - 18'	CASE TOPCASE VARIO GS	20229	(*)
R1200GS ADVENTURE	14' - 18'	CASE TOPCASE VARIO NAVIGATOR	20230	(*)
R1200GS ADVENTURE	14' - 18'	SIDE CASE ADVENTURE GS	20217	(*)
R1200GS ADVENTURE	14' - 18'	SIDE CASE ADVENTURE NAVIGATOR	20228	(*)
R1200GS ADVENTURE	14' - 18'	CASE TOPCASE ADVENTURE GS	20231	(*)
R1200GS ADVENTURE	14' - 18'	CASE TOPCASE ADVENTURE NAVIGATOR	20232	(*)
R1250GS	18' - 21'	SIDE CASE VARIO GS	20216	(*)
R1250GS	18' - 21'	SIDE CASE VARIO NAVIGATOR	20227	(*)
R1250GS	18' - 21'	CASE TOPCASE VARIO GS	20229	(*)
R1250GS	18' - 21'	CASE TOPCASE VARIO NAVIGATOR	20230	(*)
R1250GS	18' - 21'	SIDE CASE ADVENTURE GS	20217	(*)
R1250GS	18' - 21'	SIDE CASE ADVENTURE NAVIGATOR	20228	(*)
R1250GS	18' - 21'	CASE TOPCASE ADVENTURE GS	20231	(*)
R1250GS	18' - 21'	CASE TOPCASE ADVENTURE NAVIGATOR	20232	(*)
R1250GS HP	18' - 21'	SIDE CASE VARIO GS	20216	(*)
R1250GS HP	18' - 21'	SIDE CASE VARIO NAVIGATOR	20227	(*)
R1250GS HP	18' - 21'	CASE TOPCASE VARIO GS	20229	(*)
R1250GS HP	18' - 21'	CASE TOPCASE VARIO NAVIGATOR	20230	(*)
R1250GS HP	18' - 21'	SIDE CASE ADVENTURE GS	20217	(*)
R1250GS HP	18' - 21'	SIDE CASE ADVENTURE NAVIGATOR	20228	(*)
R1250GS HP	18' - 21'	CASE TOPCASE ADVENTURE GS	20231	(*)
R1250GS HP	18' - 21'	CASE TOPCASE ADVENTURE NAVIGATOR	20232	(*)
R1250GS ADVENTURE	18' - 21'	SIDE CASE VARIO GS	20216	(*)
R1250GS ADVENTURE	18' - 21'	SIDE CASE VARIO NAVIGATOR	20227	(*)
R1250GS ADVENTURE	18' - 21'	CASE TOPCASE VARIO GS	20229	(*)
R1250GS ADVENTURE	18' - 21'	CASE TOPCASE VARIO NAVIGATOR	20230	(*)
R1250GS ADVENTURE	18' - 21'	SIDE CASE ADVENTURE GS	20217	(*)
R1250GS ADVENTURE	18' - 21'	SIDE CASE ADVENTURE NAVIGATOR	20228	(*)

NOTE: THE KIT INCLUDES ADHESIVES FOR ONE CASE.
IF YOU HAVE THREE CASES, YOU MUST ORDER 3 UNITS OF THE REFERENCE.

(*) Check price with your distributor.

IMPORTANT: Indicate code color after part#. Example 0973A.

 N Black

2022		For the new 2022 motorcycle models check www.puig.tv		
MODEL	YEAR	CASE MODEL	REF.	N
R1250GS ADVENTURE	18' - 21'	CASE TOPCASE ADVENTURE GS	20231	(*)
R1250GS ADVENTURE	18' - 21'	CASE TOPCASE ADVENTURE NAVIGATOR	20232	(*)
R1250GS RALLYE	18' - 21'	SIDE CASE VARIO GS	20216	(*)
R1250GS RALLYE	18' - 21'	SIDE CASE VARIO NAVIGATOR	20227	(*)
R1250GS RALLYE	18' - 21'	CASE TOPCASE VARIO GS	20229	(*)
R1250GS RALLYE	18' - 21'	CASE TOPCASE VARIO NAVIGATOR	20230	(*)
R1250GS RALLYE	18' - 21'	SIDE CASE ADVENTURE GS	20217	(*)
R1250GS RALLYE	18' - 21'	SIDE CASE ADVENTURE NAVIGATOR	20228	(*)
R1250GS RALLYE	18' - 21'	CASE TOPCASE ADVENTURE GS	20231	(*)
R1250GS RALLYE	18' - 21'	CASE TOPCASE ADVENTURE NAVIGATOR	20232	(*)

NOTE: THE KIT INCLUDES ADHESIVES FOR ONE CASE.
IF YOU HAVE THREE CASES, YOU MUST ORDER 3 UNITS OF THE REFERENCE.

(*) Check price with your distributor.

IMPORTANT: Indicate code color after part#. Example 0973A.

 N Black

STAND SUPPORTS

HI-TECH PARTS



* Check availability for motorcycle models at www.puig.tv typing in the searching window.

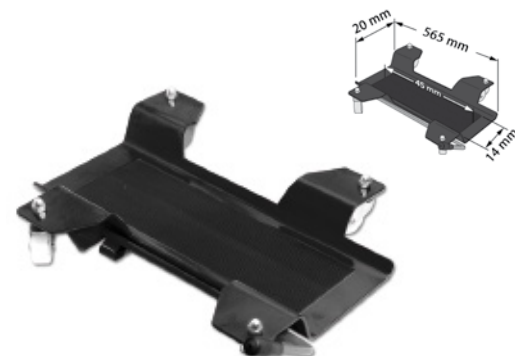

AXIS SPARE	Ø DIAMETER	D
5596D	13 mm.	(*)
5597D	15 mm.	(*)
5598D	16,5mm.	(*)
5599D	17 mm.	(*)
5600D	18 mm	(*)
9701D	27 mm.	(*)

MODEL	REF.	N
STAND SUPPORT OFF-ROAD BASIC	6289N (#)	(*)

MODEL	REF.	N
STAND SUPPORT OFF-ROAD HYDRAULIC	6290N (#)	(*)

MODEL	REF.	N
BASE PARK&MOVE FOR CENTER STAND	9974N (&)	(*)

MODEL	REF.	N
FRONT STAND	4348N	(*)

MODEL	REF.	N
FRONT HEAD STAND. INCLUDE AXIS: 13 mm., 15 mm., 16,5 mm., 17 mm., 18 mm.,	5601N	(*)

(#) Height on the lower position 310 mm.
Height on the highest position 400 mm. Maximum load: 200 kg.

(#) Height on the lower position 310 mm.
Height on the highest position 400 mm. Maximum load: 200 kg.

(&) Maximum load: 200 kg.



MODEL	REF.	N
STAND WHEEL LOCK 17" TO 21"	6071N	(*)



MODEL	REF.	N
REAR STAND FOR TWIN SWING ARMS	4322N	(*)

Include pair adaptors for spool and pair of pads for swing arm.

SPARES	REF.	P
SET OF HOOKS FOR THE REAR STAND IN SILVER	5333P	(*)
ACCESSORIES FOR SWING ARM REAR STAND	4349P	(*)

N Black **P** Silver

(*) Check price with your distributor.
IMPORTANT: Indicate code color after part#. Example 0973A.



MODEL	REF.	N
REAR STAND FOR SINGLE SWING ARM TRANSMISSION LEFT SIDE AXIS INCLUDED (1)	CHECK OUR WEBSITE	
REAR STAND FOR SINGLE SWING ARM TRANSMISSION RIGHT SIDE AXIS INCLUDED	CHECK OUR WEBSITE	

N Black **D** Aluminium Anodized

SPARE PARTS STAND	REF.	N
REAR STAND FOR SINGLE SWING ARM TRANSMISSION LEFT SIDE AXIS NOT INCLUDED	5332N	(*)
REAR STAND FOR SINGLE SWING ARM TRANSMISSION RIGHT SIDE AXIS NOT INCLUDED	5849N	(*)

AXIS SPARE	Ø DIAMETER	REF.	D
BMW (*)	53 mm.	5518D	(*)
BMW (*)	30,5 mm.	5557D	(*)
DUCATI (*)	21,5 mm.	5513D	(*)
DUCATI (*)	38,5 mm.	5897D	(*)
DUCATI (*)	40,7 mm.	5517D	(*)
MV GUSTA (*)	40,7 mm.	5517D	(*)
MV GUSTA (*)	42,5 mm	7479D	(*)
HONDA (*)	28,4 mm.	5515D	(*)
TRIUMPH (*)	27,4 mm.	5516D	(*)
KTM (*)	27,4 mm.	5516D	(*)

(*) Check bike compatibility in our website.

(*) Check price with your distributor.
IMPORTANT: Indicate code color after part#. Example 0973A.

Maintenance Workshop Maintenance Winter Maintenance Workshop

MAINTENANCE WORKSHOP WINTER

ANODIZED SCREWS KIT	611	LEGS COVER SCOOTER	612
BRUSH CLEANING CHAIN	607	MOTORCYCLE WATERPROOF COVER	612
DIGITAL TIRE PRESSURE INDICATOR	608	SOFT AND SEMI-RIGID HAND GUARDS	613
DIRTY OIL TANK	606	SPIRAL TUBES	610
ELASTIC NETS	609	STRAPS	609
FAIRING QUICK SCREWS	610	TIRE REPAIR KIT	608
HEATED GRIPS	613	TRIM - EDGING	610
KICKSTAND BASE SUPPORT	608	WELLNUTS	610
LEGS COVER MAXISCOOTER	612		



DIRTY OIL TANK

MODEL	REF.	N
DIRTY OIL TANK 8L (600 x 320 x 135 mm.)	5260N	(*)

N Black

(*) Check price with your distributor.
IMPORTANT: Indicate code color after part#. Example 0973A.

A Blue

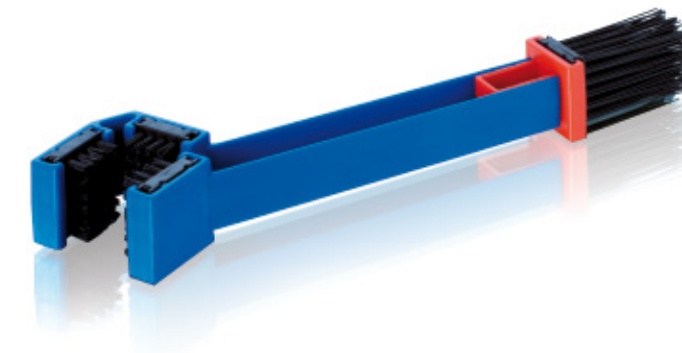

BRUSH CLEANING CHAIN

MODEL	REF.	A
BRUSH CLEANING CHAIN	5870A	(*)

(*) Check price with your distributor.
IMPORTANT: Indicate code color after part#. Example 0973A.



DIGITAL TIRE PRESSURE INDICATOR

MODEL	REF.	N
DIGITAL TIRE PRESSURE INDICATOR	5401N	(*)



TIRE REPAIR KIT

MODEL	REF.	N
TIRE REPAIR KIT	5982N	(*)



KICKSTAND BASE SUPPORT

MODEL	REF.	N
BASE FOR KICKSTAND WITH BLACK DIAMETER 80 mm.	6335N	(*)

N Black

(*) Check price with your distributor.
IMPORTANT: Indicate code color after part#. Example 0973A.

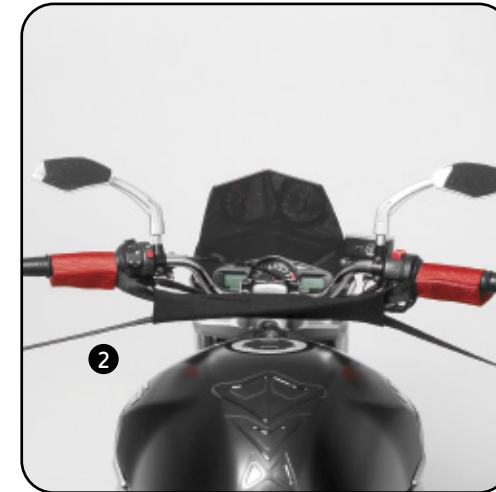

STRAPS

MODEL	REF.	N
(1) TIE DOWN WITH HOOKS BY PAIR C/BLACK	6274N	(*)
(2) BAR STRAPS BY PAIR C/BLACK	4592N	(*)



ELASTIC NETS

MODEL	REF.	B G R T V A L N
ELASTIC NET	0788	(*)

G Yellow **R** Red **V** Green **N** Black
B White **T** Orange **A** Blue **L** Violet

(*) Check price with your distributor.
IMPORTANT: Indicate code color after part#. Example 0973A.

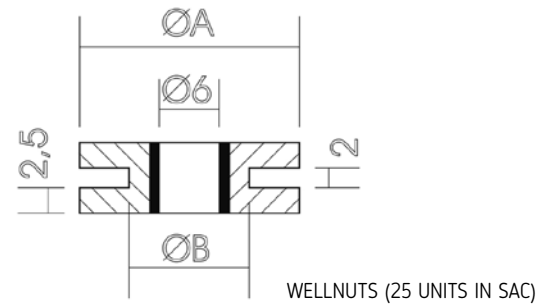

WELLNUTS

AxBxCxDxExG	REF.	N
22 x 12	1888N	(*)

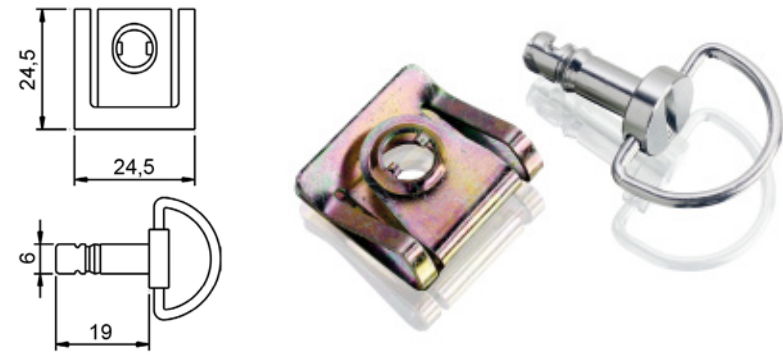

FAIRING QUICK SCREWS

MODEL	REF.	D
BLISTER 6 FAIRING QUICK SCREWS + BRACKETS	5484D	(*)

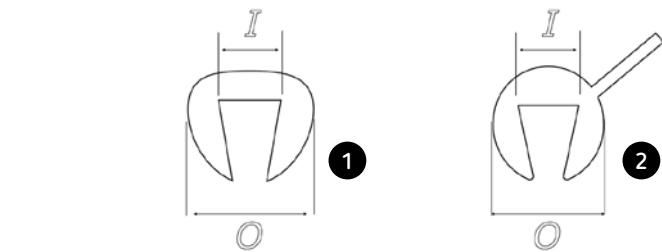

TRIM - EDGING

O x I	COLOR	REF.	ROLL	N H W
6,2 x 3,6 (1)	TRANSPARENT	4303W	200 mts.	(*)
6,2 x 3,6 (2)	SMOKE	4748H	200 mts.	(*)
3 x 1,5 (1)	BLACK	5590N	50 mts.	(*)
6 x 3 (1)	BLACK WITH ADHESIVE	0088N	25 mts.	(*)

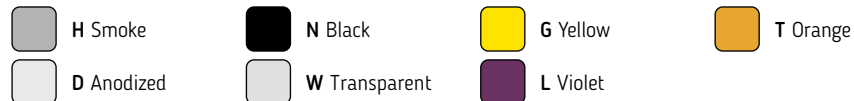

SPIRAL TUBES

MODEL	REF.	G T L
ROLL OF 10 METERS	0892G	(*)
ROLL OF 10 METERS	0892L	(*)
ROLL OF 10 METERS	0892T	(*)

(*) Check price with your distributor.
IMPORTANT: Indicate code color after part#. Example 0973A.



ANODIZED SCREWS KIT

MODEL	REF.	R A N V L G P
BLISTER 6 ALLEN SCREWS M5 x 15 mm. (1)	0146	(*)
BLISTER 6 ALLEN SCREWS M5 x 20 mm. (1)	0147	(*)
BLISTER 6 ALLEN SCREWS M5 x 25 mm. (1)	0185	(*)
BLISTER 6 ALLEN SCREWS M6 x 15 mm. (1)	0363	(*)
BLISTER 6 ALLEN SCREWS M6 x 20 mm. (1)	0364	(*)
BLISTER 6 ALLEN SCREWS M6 x 25 mm. (1)	0544	(*)
BLISTER 6 ALLEN SCREWS M6 x 30 mm. (1)	0258	(*)
BLISTER 6 ALLEN SCREWS M6 x 35 mm. (1)	0346	(*)
BLISTER 6 ALLEN SCREWS M6 x 45 mm. (1)	0370	(*)
BLISTER 6 ALLEN SCREWS M6 x 50 mm. (1)	0421	(*)

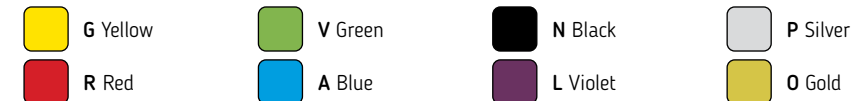

MODEL	REF.	R A N V L G P
BLISTER 6 ALLEN SCREWS M6 x 55 mm. (1)	0446	(*)
BLISTER 6 ALLEN SCREWS M8 x 30 mm. (1)	0473	(*)
BLISTER 6 ALLEN SCREWS M8 x 35 mm. (1)	0500	(*)
BLISTER 6 ALLEN SCREWS M8 x 45 mm. (1)	0516	(*)
BLISTER 6 ALLEN SCREWS M8 x 50 mm. (1)	0524	(*)
BLISTER 6 ALLEN SCREWS M8 x 55 mm. (1)	0540	(*)
BLISTER 6 LOCK NUTS M5	0735	(*)
BLISTER 6 LOCK NUTS M6	0736	(*)
BLISTER 6 LOCK NUTS M8	0832	(*)
BLISTER 6 NUTS M5	0763	(*)
BLISTER 6 NUTS M6	0764	(*)
BLISTER 6 NUTS M8	0863	(*)
BLISTER 6 ALLEN HEAD IRON THREAD SCREWS M6 x 20 mm. (2)	2542	(*)
BLISTER 6 ALLEN HEAD IRON THREAD SCREWS M6 x 30 mm. (2)	2543	(*)
PLASTIC BOX (#) (LENGTH 300 x HEIGHT 30 x WIDTH 150)	3961W (#)	(*)

(#) With 32 departaments. Delivered 6 screws each of the most common references.

(*) Check price with your distributor.
IMPORTANT: Indicate code color after part#. Example 0973A.



LEGS COVER SCOOTER

MODEL	REF.	N
UNIVERSAL LEGS COVER RAINCOAT	5508N	(*)



REF. 20726N

NEW!

MOTORCYCLE WATERPROOF COVER

MODEL	REF.	N	P
SIZE S-L MOTORCYCLES <500 / SCOOTERS	5560P	(*)	
SIZE XL-XXL MOTORCYCLES OF 600-1000CC.	5152P	(*)	
MOTORCYCLE COVER PUIG LOGO XL	20725N	(*)	
MOTORCYCLE COVER PUIG LOGO XXL	20726N	(*)	
MOTORCYCLE COVER PUIG LOGO XXXL	20727N	(*)	



LEGS COVER MAXISCOOTER

MODEL	REF.	N
UNIVERSAL LEGS COVER RAINCOAT	9749N	(*)



HEATED GRIPS

MODEL	REF.	N
SET WITH HANDLES THERMOSTAT	5020N	(*)

Note: Outside diameter of the grip 34 mm.

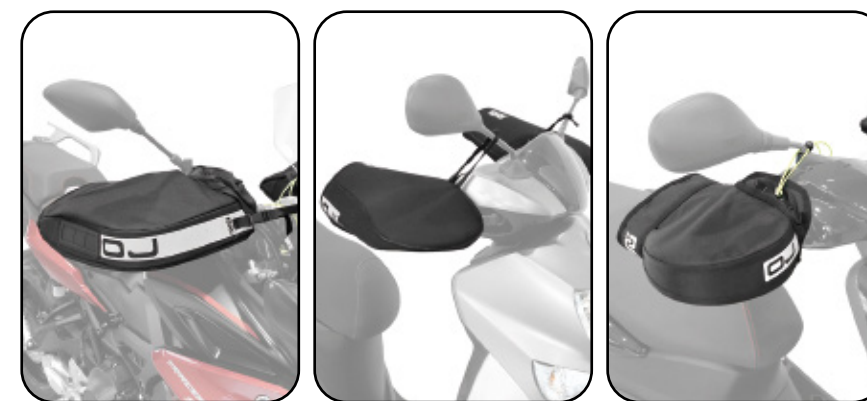

REF. 6845N

REF. 5486N

REF. 3863N

SOFT AND SEMI-RIGID HAND GUARDS

MODEL	REF.	N
UNIVERSAL SEMI-RIGID HAND GUARDS	6845N	(*)
UNIVERSAL MOTO / SCOOTER HAND GUARDS	5486N	(*)
UNIVERSAL SCOOTER HAND GUARDS	3863N	(*)

N Black

P Silver

(*) Check price with your distributor.
IMPORTANT: Indicate code color after part#. Example 0973A.

N Black

(*) Check price with your distributor.
IMPORTANT: Indicate code color after part#. Example 0973A.

Delivery Delivery Boxes Delivery Delivery Boxes Delivery Boxes

Motoplastic-Puig has a blowing division specialized in the manufacture of special trunks for the delivery sector and supports for the best-selling scooters. Presented in different formats and sizes to meet all transportation needs. They are made of polypropylene with high resistance to impact and with a certificate of suitability for contact with food. Its manufacturing system guarantees an excellent ratio between the weight of the trunk, its load capacity and shock absorption. They come in three colors and with a locking system that allows its use with or without a key. As they are references of considerable volume and as they are shipped directly from the manufacturing plant, the shipping costs will be billed separately, even if the amount paid is reached for orders over € 500 gross.

Puig
Delivery Boxes

DELIVERY

BIG BOX TOP BOX	621
MAXI BOX TOP BOX	619
MEGA BOX TOP BOX	617
TRUNK INSTALLATION KIT	623



MEGA BOX TOP BOX

HI-TECH PARTS

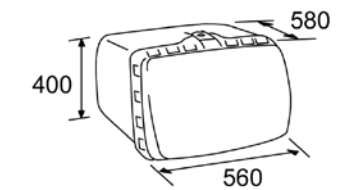

MEGA BOX WITH LOCK WITH KEY

MODEL	REF.	MATERIAL	N B R
UNIVERSAL	2328	POLYPROPYLENE	(*)
METALLIC BASE	3506N		(*)
TRAY KIT (OPTIONAL)	3844N	ABS	(*)
SPARE LOCK WITH KEY (*)	7548N		(*)
TRUNK LID	20707	POLYPROPYLENE	(*)

(*) Locking system that allows its use with or without a key.



THERMAL BAG

MODEL	REF.	R
THERMAL BAG 45 x 45 x 24 cm.	9250	(*)

■ N Black

■ B White

■ R Red

(*) Check price with your distributor.
IMPORTANT: Indicate code color after part#. Example 0973A.



MAXI BOX TOP BOX

HI-TECH PARTS | TECHNICAL SECTION

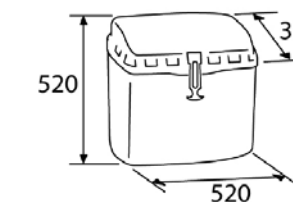
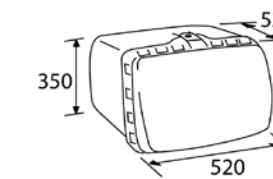

MAXI BOX WITH LOCK WITH KEY

MODEL	REF.	MATERIAL	N B R
UNIVERSAL	0468	POLYPROPYLENE	(*)
TRAY KIT (OPTIONAL)	1886N	ABS	(*)
SPARE LOCK WITH KEY (*)	7548N		(*)
METALLIC BASE	9329N		(*)
SQUARE HINGE	9851N		(*)
PIVOT	3808N		(*)

(*) Locking system that allows its use with or without a key.

MAXI BOX WITH LOCK AND FIXED WITH CINCHES

MODEL	REF.	MATERIAL	N B R
UNIVERSAL	3659	POLYPROPYLENE	(*)
HOOKS BY PAIR	3828		(*)

THERMAL BAG

MODEL	REF.	R
THERMAL BAG 45 x 45 x 24 cm.	9250	(*)

 N Black

 B White

 R Red

SEE PAGE 623 FOR AVAILABILITY OF SPECIFIC SUPPORTS FOR SCOOTERS.

(*) Check price with your distributor.

IMPORTANT: Indicate code color after part#. Example 0973A.

BIG BOX TOP BOX

HI-TECH PARTS | TECHNICAL SECTION

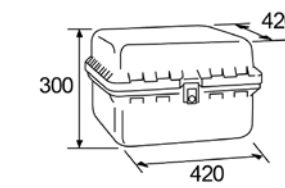

60 L.

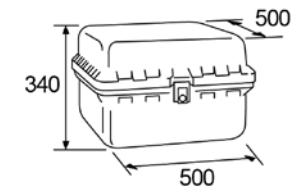

90 L.

BIG BOX WITH LOCK WITH KEY

MODEL	REF.	MATERIAL	N B R
UNIVERSAL 60L.	0390	POLYPROPYLENE	(*)
UNIVERSAL 90L.	0713	POLYPROPYLENE	(*)
SPARE LOCK WITH KEY (*)	7548N		(*)
SPARE SIDE LOCK	3192N		(*)

(*) Locking system that allows its use with or without a key.



THERMAL BAG

MODEL	REF.	R
THERMAL BAG 45 x 45 x 24 cm.	9250	(*)

(*) Compatible only with Big Box 90L. (Ref. 0713).

N Black

B White

R Red

SEE PAGE 623 FOR AVAILABILITY OF SPECIFIC SUPPORTS FOR SCOOTERS.

(*) Check price with your distributor.

IMPORTANT: Indicate code color after part#. Example 0973A.

TRUNK INSTALLATION KIT

HI-TECH PARTS | TECHNICAL SECTION

Puig
Delivery Boxes

NEW!

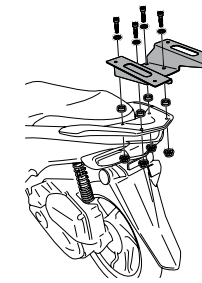

EASE
For assembly, all the necessary hardware is supplied for the indicated models.

SECURITY
Studied to properly support the trunk.

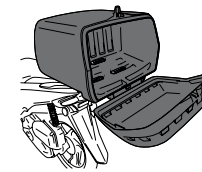

EFFICIENCY
They leave the suitcase in a horizontal position ensuring proper food transport.

FUNCTIONALITY
They allow the correct opening of the scooter seat.



REF. 20572N



MODEL	REF.	MATERIAL	N
HONDA			
SCOOPY SH125i	13' - 16'	20640	(*)
SCOOPY SH125i	17' - 19'	20641	(*)
SCOOPY SH125i	20' - 21'	20642	(*)
PCX 125	18' - 21'	20572	(*)
VISION 110	17' - 21'	20573	(*)
KYMCO			
AGILITY CITY 50/125	15' - 21'	20639	(*)
SYM			
SYMPHONY SR 50	11' - 21'	20580	(*)
SYMPHONY SR 125	11' - 21'	20580	(*)
SYMPHONY SR 125 TOP	11' - 21'	20580	(*)
SYMPHONY SR 150	11' - 18'	20580	(*)

N Black

(*) Check price with your distributor.
IMPORTANT: Indicate code color after part#. Example 0973A.

**Merchar
andising
Merchar
andising
Merchar
andising**

MERCHANDISING

ANODIZED PIECES DISPLAY	627	HI-TECH PARTS DISPLAY	627
BACKPACK	630	HOODIE	631
BUFF	630	JACKET SOFTSHELL	631
CAP	630	KEYCHAINS	630
CATALOG	628	METACRYLATE PUIG	628
CLOCK	629	PEN / NOTEBOOK	628
DISPLAY SCREENS	626	PUIG STICKERS	628
DISPLAY STRIP	626	RUG	629
FLAG	629	T-SHIRTS	631
FLASK	629	TURN SIGNALS DISPLAY	626
GLOVES	631	VISOR DISPLAY	626

MERCHANDISING

HI-TECH PARTS



DISPLAY SCREENS

MODEL	REF.
DISPLAY SCREENS COLORS	1196R

DISPLAY STRIP

MODEL	REF.
STRIP COLOR DISPLAY	9180N



REF. 9665R

VISOR DISPLAY

MODEL	REF.	N
VISOR DISPLAY	20497N	(*)

TURN SIGNALS DISPLAY

MODEL	REF.	N
TURN SIGNALS DISPLAY	20860N	(*)



REF. 20315N

ANODIZED PIECES DISPLAY

MODEL	REF.	N	R
DISPLAY LEVER + REAR MIRROR + BAR END + GRIP	9665R		(*)
DISPLAY LEVER 3.0	20315N		(*)

HI-TECH PARTS DISPLAY

MODEL	REF.	N
HI-TECH PARTS DISPLAY 854 x 1900 mm.	7324N	(*)

N Black

R Red

(*) Check price with your distributor.
IMPORTANT: Indicate code color after part#. Example 0973A.

N Black

R Red

(*) Check price with your distributor.
IMPORTANT: Indicate code color after part#. Example 0973A.

MERCHANDISING

HI-TECH PARTS



CATALOG

MODEL	REF.
CATALOG 2022 SPANISH VERSION	20847N
CATALOG 2022 FRENCH VERSION	20848N
CATALOG 2022 ENGLISH VERSION	20849N
CATALOG 2022 GERMAN VERSION	20850N



PUIG STICKERS

MODEL	REF.	N
LARGE PUIG ADHESIVE 400 mm.	9348N	(*)
ADHESIVE PUIG MEDIUM 135 x 33 mm.	9349N	(*)



FLAG

MODEL	REF.	N
FLAG 200 x 50 cm. PUIG HI-TECH PARTS	3669N	(*)



FLASK

MODEL	REF.	N
FLASK 500 ml.	20499N	(*)



METACRYLATE PUIG

MODEL	REF.	B
METACRYLATE PUIG 680 x 300 x 3 mm.	2203B	(*)



PEN / NOTEBOOK

MODEL	REF.	N
PEN	9347N	(*)
NOTEBOOK	9312N	(*)



RUG

MODEL	REF.	N
RUG PUIG 2000 x 800 mm.	6362N	(*)

FABRICADO: 100% Nylon, antideslizante y resistente al agua.



CLOCK

MODEL	REF.	N
CLOCK PUIG HI-TECH PARTS Ø 30 cm.	9856N	(*)

N Black

B White

(*) Check price with your distributor.
IMPORTANT: Indicate code color after part#. Example 0973A.

N Black

(*) Check price with your distributor.
IMPORTANT: Indicate code color after part#. Example 0973A.

MERCHANDISING

HI-TECH PARTS



BUFF

MODEL	REF.	N
BUFF PUIG	9345N	(*)



BACKPACK

MODEL	REF.	N
BACKPACK PUIG	9228N	(*)



UNISEX T-SHIRTS

MODEL	REF.	N
SIDE S	4335N	(*)
SIDE M	4334N	(*)
SIDE L	4333N	(*)
SIDE XL	4332N	(*)
SIDE XXL	4336N	(*)
SIDE XXXL	9343N	(*)



JACKET SOFTSHELL

MODEL	REF.	N
SIDE XS	9857N	(*)
SIDE S	9858N	(*)
SIDE M	9859N	(*)
SIDE L	9860N	(*)
SIDE XL	9861N	(*)
SIDE XXL	9862N	(*)
SIDE XXXL	9863N	(*)



HOODIE

MODEL	REF.	N
SIDE XS	3746N	(*)
SIDE S	3747N	(*)
SIDE M	3748N	(*)
SIDE L	3749N	(*)
SIDE XL	3750N	(*)
SIDE XXL	3751N	(*)
SIDE XXXL	3752N	(*)



KEYCHAINS

MODEL	REF.	N
KEYCHAIN WITH TAPE	9227N	(*)
KEY SUPPORT WITH ZIP CLOSURE	8120N	(*)



CAP

MODEL	REF.	N
CAP HI-TECH PARTS	9346N	(*)



NEW!

GLOVES

MODEL	REF.	N
SIDE XS	20785N	(*)
SIDE S	20786N	(*)
SIDE M	20787N	(*)
SIDE L	20788N	(*)
SIDE XL	20789N	(*)

N Black

(*) Check price with your distributor.
IMPORTANT: Indicate code color after part#. Example 0973A.

N Black

(*) Check price with your distributor.
IMPORTANT: Indicate code color after part#. Example 0973A.



SALES CONDITIONS

- 1% extra discount sending the order through our extranet on www.puig.tv.

RETURN PROCEDURES

- No return will be accepted after 3 months from shipping note.
- The return must be accepted from Motoplastic S.A., after verification of the material by an agent in the area or, otherwise, through an email sent to devoluciones@puig.tv requesting the return along with detailed images.
- If the return is not Motoplastic's fault, 20% devaluation will be applied and material will need to be sent paid for.
- If the return is because of the transport, the customer will need to send us the transporter's shipping note where should be noted, at the time of the reception of the cartons, the disagreement of the condition of the material. Additionally, images of the cartons in bad condition will need to be sent to us.

BRAND AND IMAGES

PUIG® is a registered brand.

The images from this catalog and site www.puig.tv are property of Motoplastic, S.A. and need authorization from Motoplastic, S.A. for its use.

Motoplastic, s.a. does not have any link with brands HONDA, YAMAHA, SUZUKI, KAWASAKI, APRILIA, BMW, BUELL, CAGIVA, DERBI, DUCATI, HYOSUNG, KTM, MV AGUSTA, PEUGEOT, TRIUMPH and others mentioned. All products registered brand, model or initials, are named with only purpose to cross reference with accessories of our own production.

HEADQUARTERS

MOTOPLASTIC, S.A.
Passeig de la Ribera, nº29
08403 Granollers
Spain
Tel. (+34) 938 49 06 33
info@puig.tv

UNITED STATES

PUIG USA INC.
3843 St. Valentine Way
Orlando, FL 32811
Ph. (+1) 407.237.0207
info@puigusa.com

AGENT ET DISTRIBUTEUR EXCLUSIF POUR LA FRANCE / BELGIQUE FRANCOPHONE / LUXEMBOURG: ARTECH SAS

ZAC DU LONG BUISSON
180 Rue Clément Ader, Bâtiment 1
27000 Evreux - France
Tel. (+33) 02 32 305 305
Fax (+33) 02 32 305 306
puig.artech@orange.fr
puig@groupeartech.fr

Puig
Hi-Tech Parts

W W W . P U I G . T V